

APCTM

AMERICAN POWER CONVERSION

Smart-UPS[®]

Models 600RM, 900XLRM,
1250RM and 2000RM

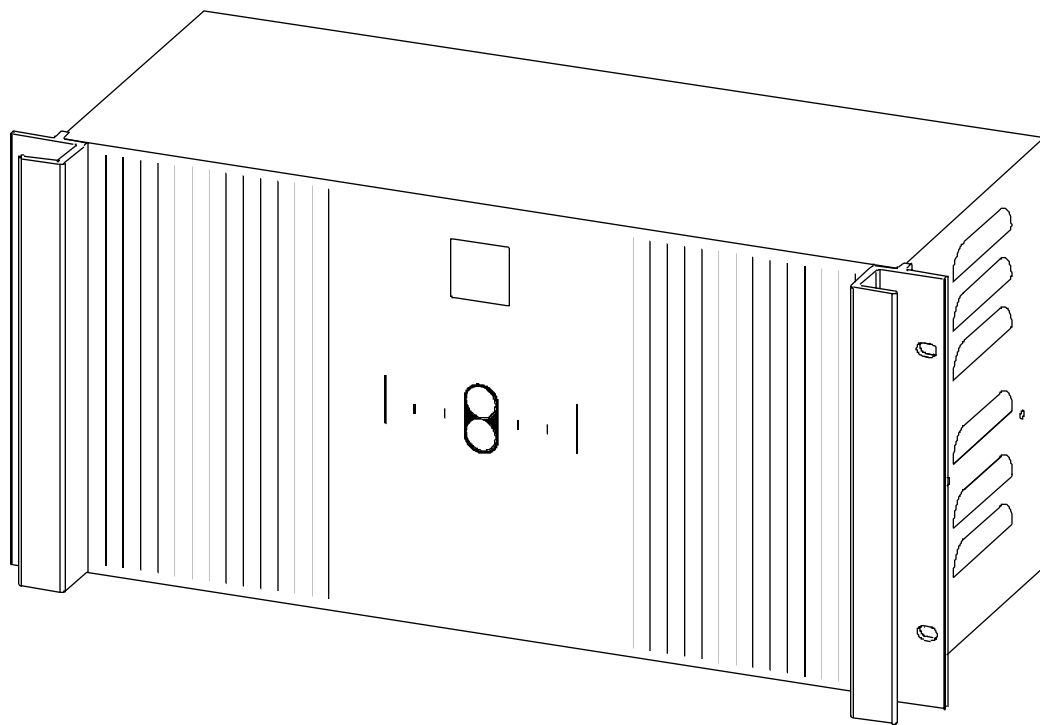

**User's
Manual**

Important safety instructions!

Please read this manual!

Veillez lire ce manuel!

Bitte lesen Sie dieses Anleitungshandbuch!

¡Se ruega leer este manual de instrucciones!

This manual provides safety, installation and operating instructions that will help you derive the fullest performance and service life that the UPS has to offer.

PLEASE SAVE THIS MANUAL! It includes important instructions for the safe use of this UPS and for obtaining factory service should the proper operation of the UPS come into question. Down the road, service or storage issues may arise and require reference to this manual.

CONSERVER CES INSTRUCTIONS ! Cette notice contient des instructions importantes concernant la sécurité.

Radio Frequency Interference

WARNING: Changes or modifications to this unit not expressly approved by the party responsible for compliance could void the user's authority to operate the equipment.

NOTE: This equipment has been tested and found to comply with the limits for a Class A digital device pursuant to Part 15 of the FCC Rules. These limits are designed to provide reasonable protection against harmful interference when the equipment is operated in a commercial environment. This equipment generates, uses, and can radiate radio frequency energy and, if not installed and used in accordance with the instruction manual, may cause harmful interference to radio communications. Operation of this equipment in a residential area is likely to cause harmful interference in which case the user will be required to correct the interference at his own expense.

Shielded signaling cables must be used with this unit to ensure compliance with the Class A FCC limits.

This digital apparatus does not exceed the Class A limits for radio noise emissions from digital apparatus set out in the Radio Interference Regulations of the Canadian Department of Communications.

Le présent appareil numérique n'émet pas de bruits radioélectriques dépassant les limites applicables aux appareils numériques de la Class A prescrites dans le Règlement sur le brouillage radioélectrique édicte par le ministère des Communications du Canada.

Hiermit wird bescheinigt, dass der Smart-UPS 600RM, 900XLRM, 1250RM, 2000RM Ununterbrechbare Stromversorgungs-Gerät in Unereinstimmung mit den Bestimmungen der Vfg 1046/1984 funk-entstort ist. Der Deutschen Bundespost wurde das Inverkehrbringen diese Gerates angezeigt und die Berechtigung zur Überprüfung der Serie auf Einhaltung der Bestimmungen eingeräumt.

Table of contents

1.0	Introduction	2
2.0	Safety!	4
	Sécurité! (Français)	5
	Sicherheit! (Deutsch)	6
	¡Seguridad! (Español)	7
3.0	Presentation	8
	600VA and 1250VA models	8
	900VA models	9
	2000VA models	10
4.0	Installation	14
5.0	Operation	18
6.0	UPS monitoring	26
7.0	Difficulty	28
	Difficulté (Français)	29
	Schwierigkeit (Deutsch)	30
	Dificultad (Español)	31
8.0	Storing the UPS	35
9.0	Specifications	36
	Typical run time versus load; 600VA, 1250VA and 2000VA models	38
	Typical run time versus load, 900VA extended run model	39

1.0 Introduction

1.1 Overview

This equipment is a high performance line interactive uninterruptible power source (UPS) designed to provide clean, reliable AC power to computer loads. The UPS's line interactive circuit topology, illustrated below, offers excellent efficiency, on-line voltage regulation and fast utility fault response.

The UPS's DC-to-AC inverter is always connected to the output and when operating on-line, a portion of the inverter circuitry is put to work "in reverse" to continuously maintain optimum float charge on the battery. The inverter circuitry also acts to protect the load from surges and EMI/RFI noise as part of an advanced hybrid surge suppression and filtering network. A unique mode of operation, named SmartBoost, serves to regulate the load voltage by compensating for brownouts or sags. This is accomplished without the need to draw power from the UPS's battery. In anticipation of utility failure, the UPS continuously monitors the line and prepares the inverter frequency for synchronous transfer of the load. Upon occurrence of utility voltage failure such as a blackout, severe brownout or an overvoltage condition, the UPS transfers the load to power derived from the battery. Transfer to the "on-battery" mode of operation takes place typically within 2 milliseconds. The inverter's output voltage waveshape is a low distortion sine wave. Resynchronization and retransfer to on-line operation is automatic upon recovery of the line voltage to within normal limits.

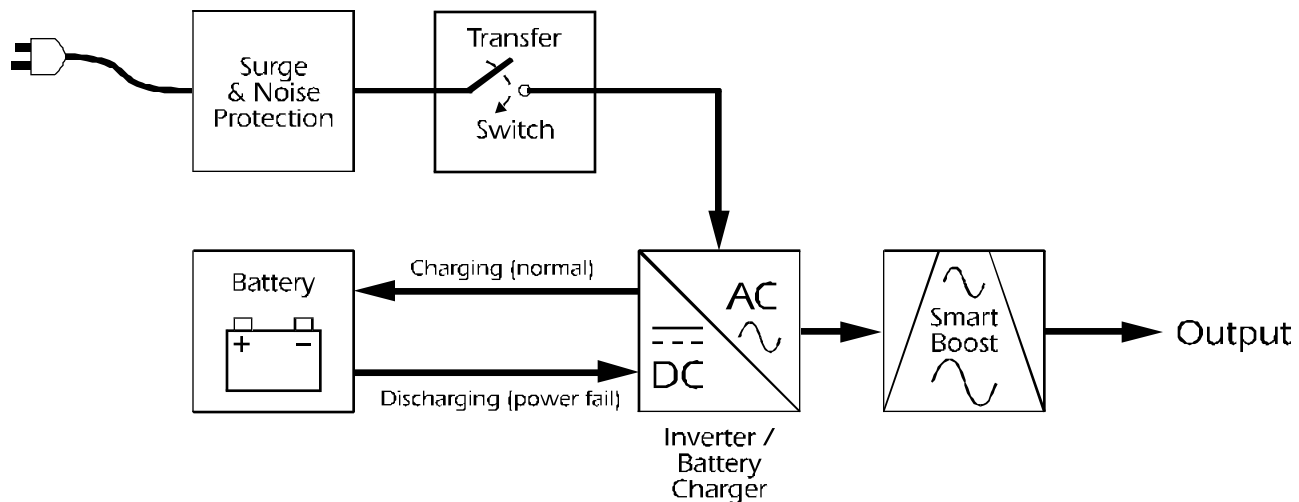

Line interactive UPS block diagram

1.0 Introduction

1.2 SmartBoost

SmartBoost allows continuous on-line operation during extended brownouts or low line voltage conditions. The UPS compensates for the reduced line voltage by boosting the load voltage to a value 12% above the input. Reliability is enhanced because the limited battery capacity is saved for complete utility failures.

1.3 Battery replacement indicators and test

The UPS provides both visual and audible Replace Battery indications. The indications are based on the result of an actual load test on the battery. By exercising the UPS's battery during a startup test, the UPS is able to detect a weak battery before it is put into service. In applications where the UPS is not turned off daily, or where the UPS is purposely left operating unattended, the UPS automatically conducts this self test every 14 days.

1.4 Remote interfaces

The UPS provides a remote computer interface capable of full bidirectional RS-232 communications. When combined with PowerDoctor UPS monitoring software and a serially connected local DOS PC, power quality related events can be logged. Power-Chute *plus* offers all the features of PowerDoctor, plus the ability to control orderly and unattended network or multi-user computer system shutdown during an extended power outage. Also available for the UPS is the SNMP (Simple Network Management Protocol) Adapter to provide load type independent remote monitoring and management across Ethernet or Token Ring based LANs or WANs capable of routing IP messages. Using any standard Network Management System (NMS) and the SNMP Adapter, the UPS becomes manageable through a single familiar interface - from across your building to across the world.

1.5 Extended capabilities

Via the UPS's remote interface, the user can access advanced monitoring, power management and operation customizing functions. Monitored parameters include available run time, line voltage, line frequency, output power, output voltage, battery capacity, battery voltage and internal temperature. Power management functions include scheduled shutdown, power failure simulation, and remote turn off. UPS functions that can be customized include the automatic self test and low battery warning intervals; shut down, turn-off and turn-on delay intervals; transfer voltage; utility fault sensitivity; and activation of the audible alarm.

2.0 Safety !

ENGLISH

Caution!



CAUTION !

- To reduce the risk of electric shock, disconnect the Uninterruptible Power Source from the mains before installing computer interface signal cable (when used). Reconnect the power cord only after all signalling interconnections have been made.
- Connect the Uninterruptible Power Source to a two-pole, three-wire grounding mains receptacle. The receptacle must be connected to appropriate branch protection (fuse or circuit breaker). Connection to any other type of receptacle may result in a shock hazard and may violate local electrical codes.
- This Uninterruptible Power Source has an internal energy source (the battery) that cannot be de-energized by the user. **The output may be energized when the unit is not connected to a mains supply.**
- To properly deenergize the Uninterruptible Power Source in an emergency, move the rear panel I/O switch to the O (off) position and disconnect the power cord from the mains.
- Avoid installing the Uninterruptible Power Source in locations where there is water or excessive humidity.
- Do not allow water or any foreign object to get inside the Uninterruptible Power Source. Do not put objects containing liquid on or near the unit.
- To reduce the risk of overheating the Uninterruptible Power Source, avoid exposing the unit to the direct rays of the sun. Avoid installing the unit near heat emitting appliances such as a room heater or stove.

Attention!



ATTENTION!

- Pour réduire le risque d'électrocution, débranchez la prise principale de la source d'alimentation permanente (Uninterruptible Power Source), avant d'installer le câble d'interface allant à l'ordinateur (si utilisé). Ne rebranchez le bloc d'alimentation qu'après avoir effectué toutes les connections.
- Branchez la source d'alimentation permanente (UPS) dans une prise de courant à 3 dérivations (deux pôles et la terre). Cette prise doit être munie d'une protection adéquate (fusible ou coupe-circuit). Le branchement dans tout autre genre de prise pourrait entraîner un risque d'électrocution et peut constituer une infraction à la réglementation locale concernant les installations électriques.
- Cette source d'alimentation permanente (UPS) est munie d'une source d'énergie interne (accumulateur) qui ne peut pas être désactivée par l'utilisateur. **La prise de sortie peut donc être sous tension même lorsque l'appareil n'est pas branché.**
- En cas d'urgence, pour désactiver correctement la source d'alimentation permanente (UPS), poussez l'interrupteur du panneau arrière sur la position O (Off) et débranchez le cordon d'alimentation principal.
- Ne pas installer la source d'alimentation permanente (UPS) dans un endroit où il y a de l'eau ou une humidité excessive.
- Ne pas laisser de l'eau ou tout objet pénétrer dans la source d'alimentation permanente (UPS). Ne pas placer de récipients contenant un liquide sur cet appareil, ni à proximité de celui-ci.
- Pour éviter une surchauffe de la source d'alimentation permanente (UPS), conservez-la à l'abri du soleil. Ne pas installer à proximité d'appareils dégagant de la chaleur tels que radiateurs ou appareils de chauffage.

Vorsicht!



VORSICHT!

- Um die Gefahr eines elektrischen Schlages auf ein Minimum zu reduzieren, die unterbrechungsfreie Stromversorgung vom Stromnetz trennen, bevor ggf. ein Computer-Schnittstellensignalkabel angeschlossen wird. Das Netzkabel erst nach Herstellung aller Signalverbindungen wieder einstecken.
- Die unterbrechungsfreie Stromversorgung an eine geerdete zweipolige Dreiphasen-Netzsteckdose anschließen. Die Steckdose muß mit einem geeigneten Abzweigschutz (Sicherung oder Leistungsschalter) verbunden sein. Der Anschluß der unterbrechungsfreien Stromversorgung an einen anderen Steckdosentyp kann zu Stromschlägen führen und gegen die örtlichen Vorschriften verstoßen.
- Diese unterbrechungsfreie Stromversorgung besitzt eine interne Energiequelle (Batterie), die vom Benutzer nicht abgeschaltet werden kann. **Der Ausgang kann eingeschaltet werden, wenn das Gerät nicht an das Stromnetz angeschlossen ist.**
- Um die unterbrechungsfreie Stromversorgung im Notfall ordnungsgemäß abzuschalten, den I/O-Schalter an der Rückseite auf O (Aus) stellen und das Netzkabel aus der Steckdose ziehen.
- Die unterbrechungsfreie Stromversorgung nicht an einem Ort aufstellen, an dem sie mit Wasser oder übermäßig hoher Luftfeuchtigkeit in Berührung kommen könnte.
- Darauf achten, daß weder Wasser noch Fremdkörper in das Innere der unterbrechungsfreien Stromversorgung eindringen. Keine Objekte, die Flüssigkeit enthalten, auf oder neben die unterbrechungsfreie Stromversorgung stellen.
- Um ein Überhitzen der unterbrechungsfreien Stromversorgung zu verhindern, das Gerät vor direkter Sonneneinstrahlung fernhalten und nicht in der Nähe von wärmeabstrahlenden Haushaltsgeräten (z.B. Heizgerät oder Herd) aufstellen.



¡ATENCIÓN!

- Para reducir el riesgo de descarga eléctrica, desconecte de la red la Fuente de energía ininterrumpible antes de instalar el cable de señalización de interfaz de la computadora (si se usa). Vuelva a conectar el conductor flexible de alimentación solamente una vez efectuadas todas las interconexiones de señalización.
- Conecte la Fuente de energía ininterrumpible a un tomacorriente bipolar y trifilar con neutro de puesta a tierra. El tomacorriente debe estar conectado a la protección de derivación apropiada (ya sea un fusible o un disyuntor). La conexión a cualquier otro tipo de tomacorriente puede constituir peligro de descarga eléctrica y violar los códigos eléctricos locales.
- Esta Fuente de energía ininterrumpible tiene una fuente de energía interna (la batería) que no puede ser desactivada por el usuario. **La salida puede tener corriente aun cuando la unidad no se encuentre conectada al suministro de red.**
- Para desactivar correctamente la Fuente de energía ininterrumpible en una situación de emergencia, coloque el interruptor I/O del panel posterior en la posición O (Off - desconectado) y desconecte de la red el conductor flexible de alimentación.
- No instale la Fuente de energía ininterrumpible en lugares donde haya agua o humedad excesiva.
- No deje que en la Fuente de energía ininterrumpible entre agua ni ningún objeto extraño. No ponga objetos con líquidos encima de la unidad ni cerca de ella.
- Para reducir el riesgo de sobrecalentamiento, no exponga la unidad a los rayos directos del sol ni la instale cerca de artefactos que emiten calor, como estufas o cocinas.

3.0 Presentation

3.1 600VA and 1250VA models

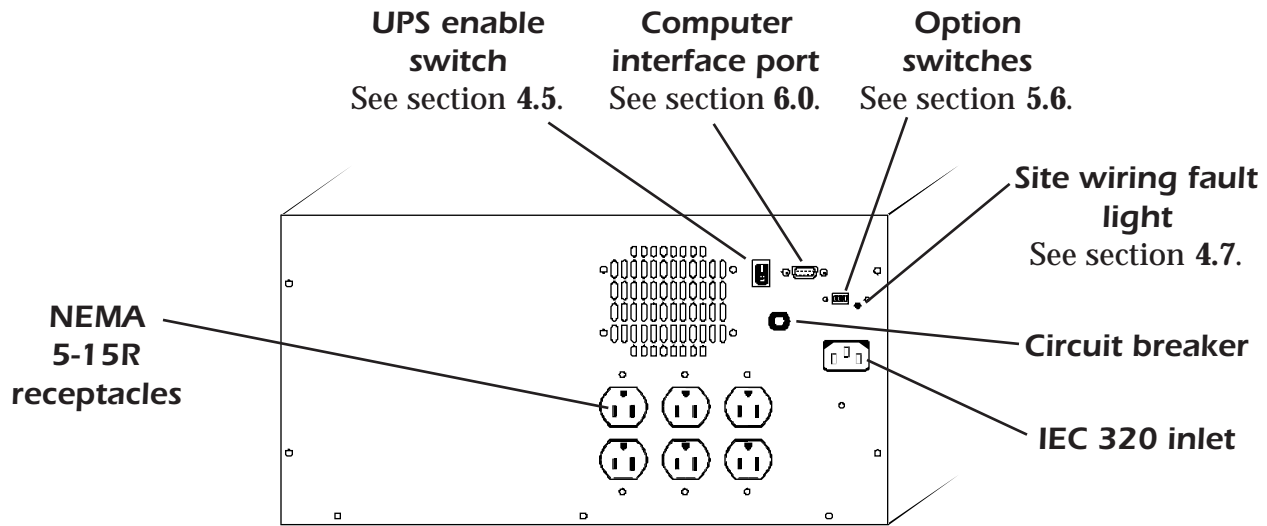
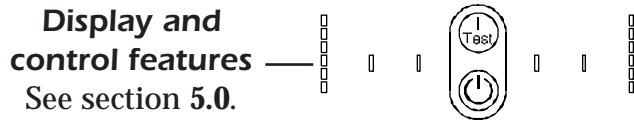

Rear view - 120 Vac version

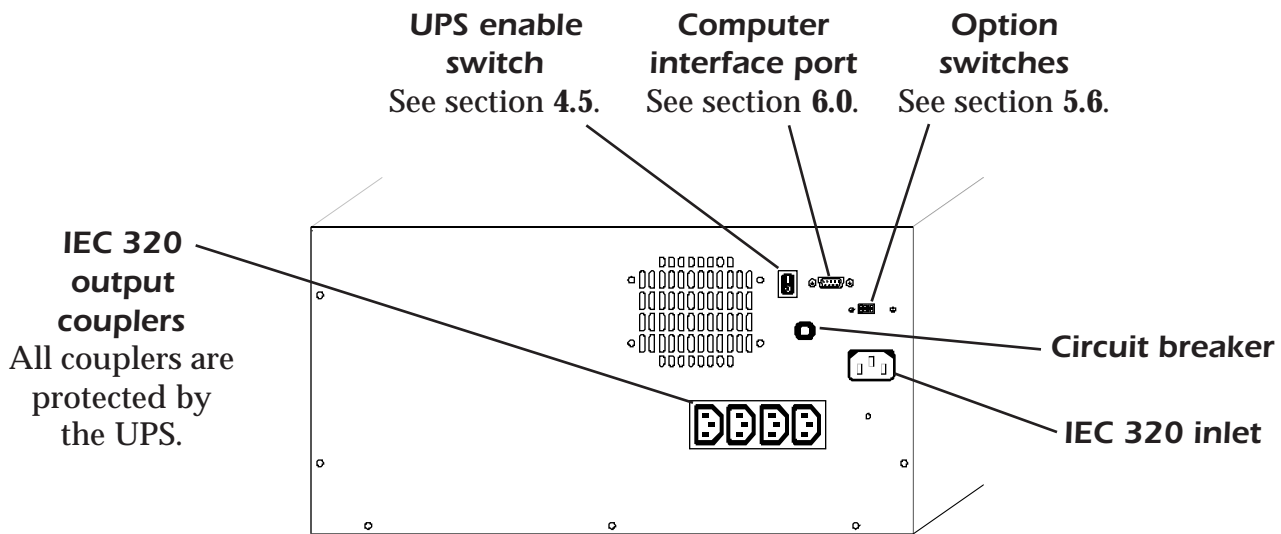

Rear view - 220/230/240 Vac version

3.0 Presentation

3.2 900VA model

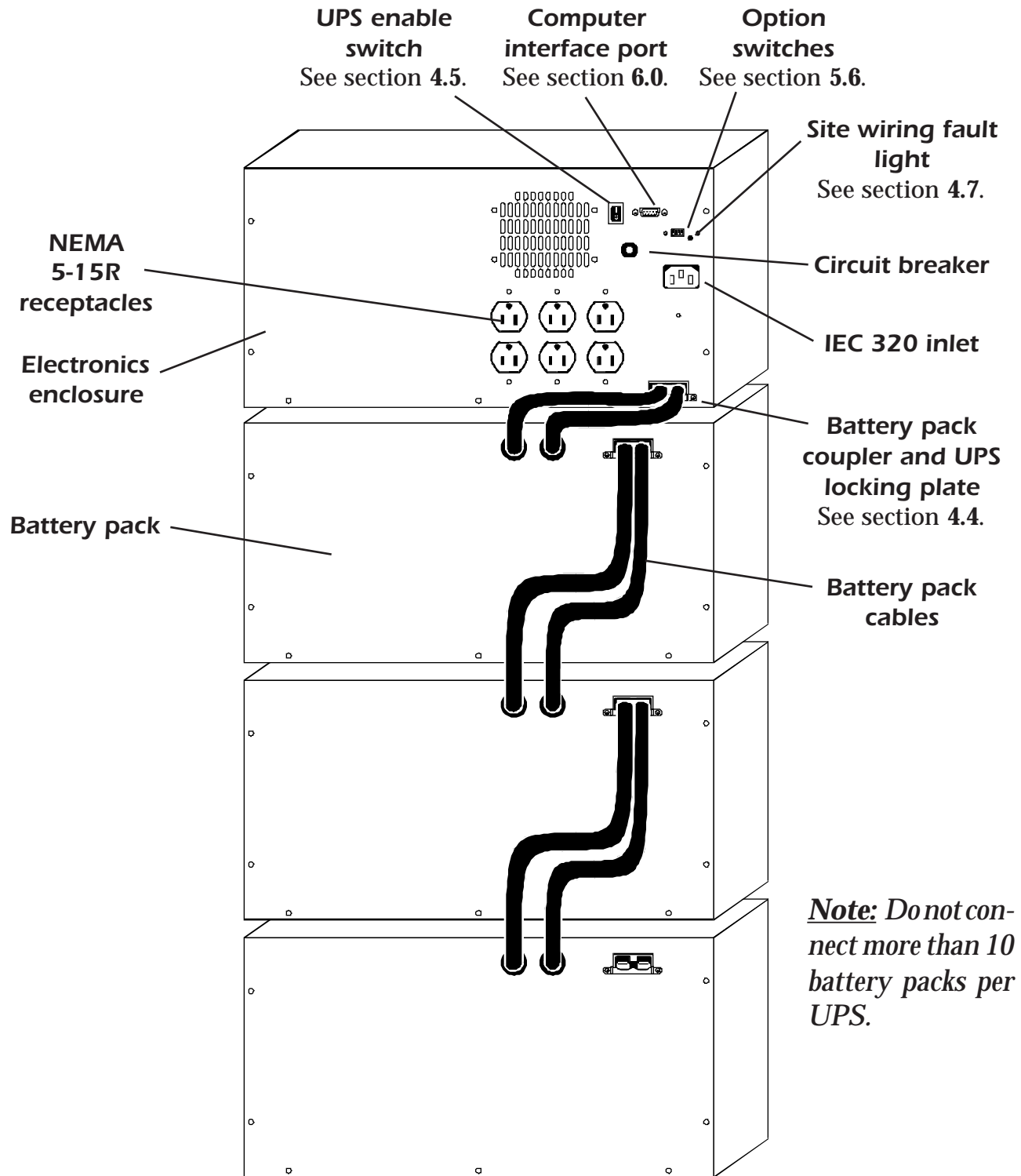

Rear view - 120 Vac version with 3 Battery packs shown

3.0 Presentation

3.3 2000VA model - 120 Vac version

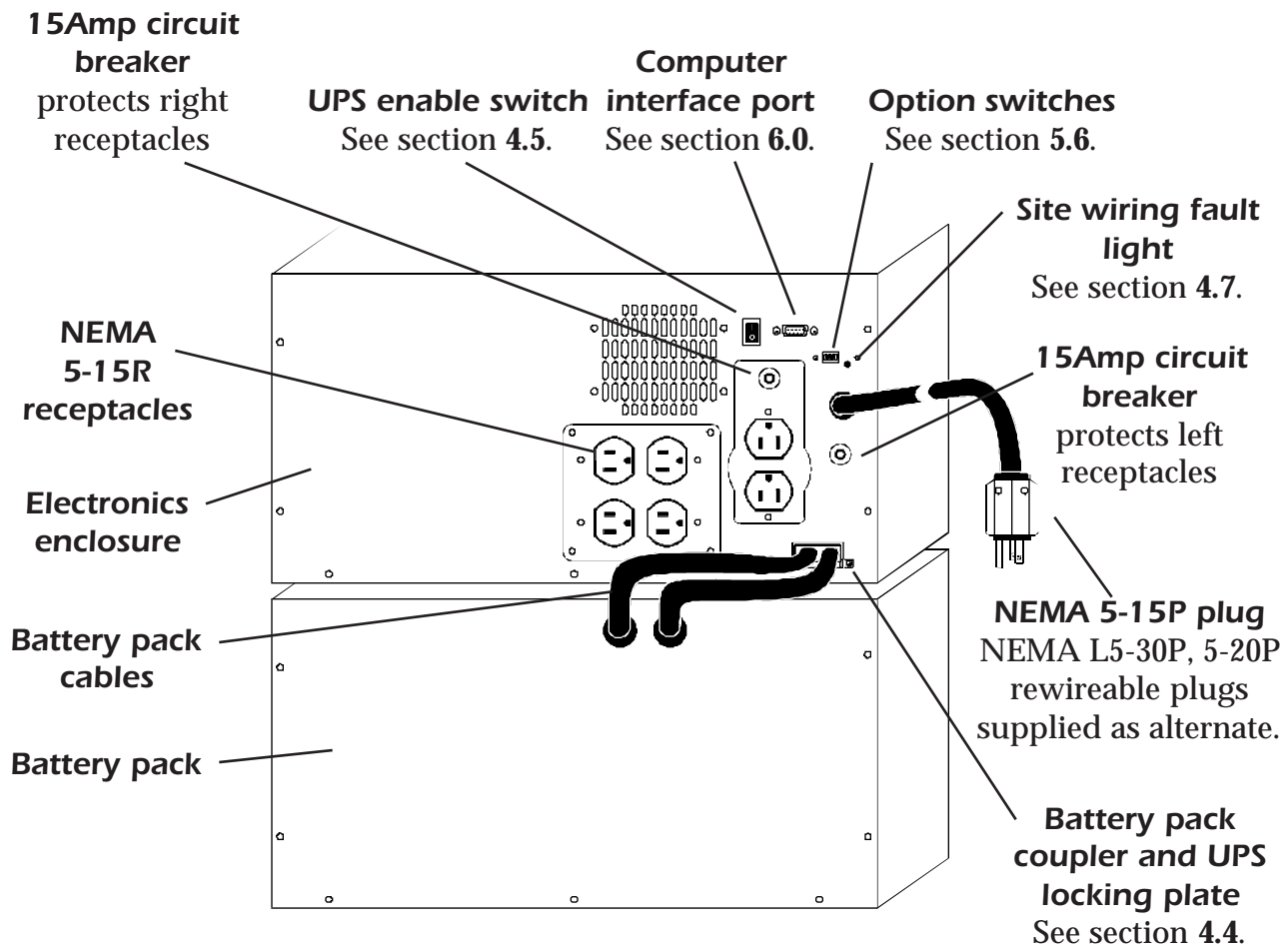
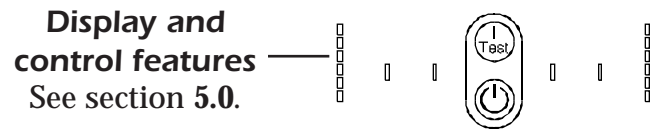

Rear view

3.0 Presentation

3.4 2000VA model - 120 Vac versions options

The -1, -2 and -4 wiring device options for the 120 Vac version 2000VA model UPS are shown below for reference. These options allow simple plug-in installation of the UPS where special service or load wiring devices are used.

Note: Option -3 has been replaced by an improved standard version - it is no longer offered.

Note: Due to the difference in available capacity of the UPS and the maximum usable current ratings of the wiring devices, UPSs furnished with -1 and -2 wiring device options are derated to 1850 VA.

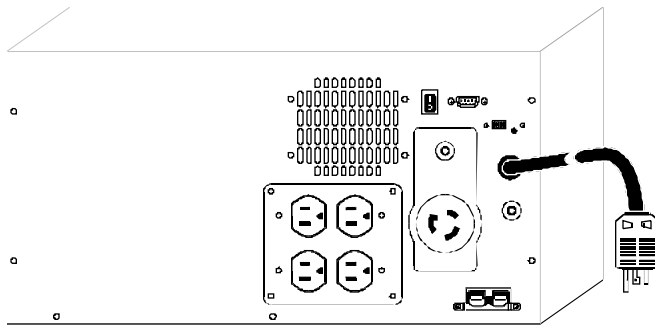

Option -1

3.4.1 Option -1 UPSs have the following wiring devices:

- (1) NEMA L5-20R twist lock receptacle,
- (2) NEMA 5-15R duplex receptacles,
- (1) NEMA L5-20P twist lock input plug.

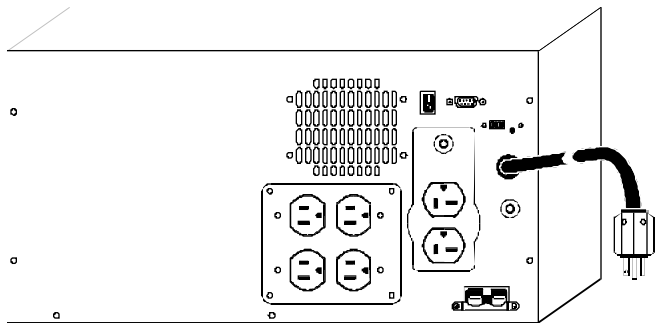

Option -2

3.4.2 Option -2 UPSs have the following wiring devices:

- (1) 5-20R duplex receptacle,
- (2) NEMA 5-15R duplex receptacles,
- (1) NEMA 5-20P input plug.

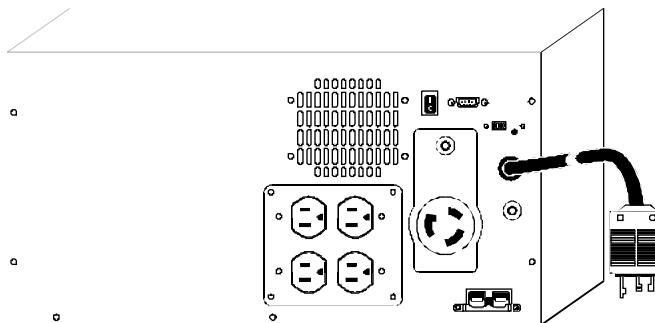

Option -4

3.4.3 Option -4 UPSs have the following wiring devices:

- (1) NEMA L5-30R twist lock receptacle,
- (2) NEMA 5-15R duplex receptacles,
- (1) NEMA L5-30P twist lock input plug.

3.0 Presentation

3.5 2000VA model - 208 Vac version and options

The standard 208 Vac version 2000VA model UPS and its wiring device options are shown below for reference. These options allow simple plug-in installation of the UPS where special service or load wiring devices are used.

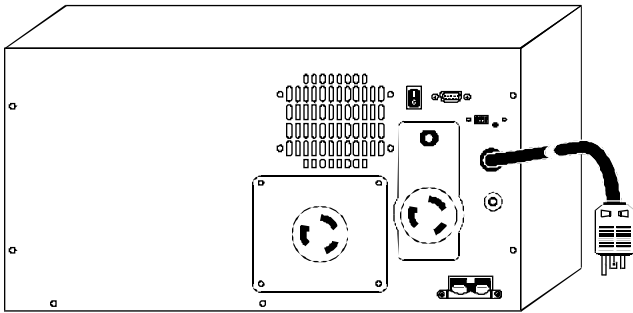

Standard

3.5.1 Standard 208 Vac version UPSs have the following wiring devices:

- (2) NEMA L6-30R twist lock receptacles,
- (1) NEMA L6-30P twist lock input plug.

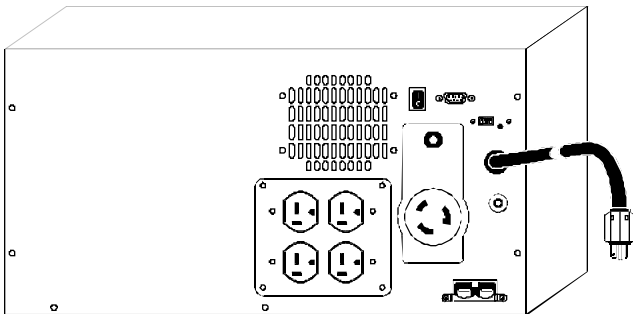

Option -1

3.5.2 Option -1 208 Vac version UPSs have the following wiring devices:

- (1) NEMA L6-20R twist lock receptacle,
- (2) NEMA 6-20R duplex receptacles,
- (1) NEMA 6-20P input plug - a NEMA L6-20P rewirable twist lock plug is provided as an alternate.

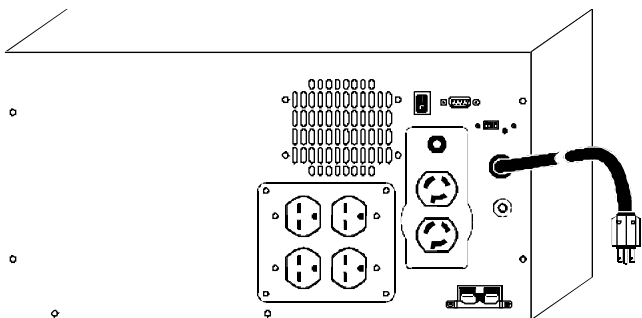

Option -2

3.5.3 Option -2 208 Vac version UPSs have the following wiring devices:

- (1) NEMA L6-15R twist lock duplex receptacle,
- (2) NEMA 6-15R duplex receptacles,
- (1) NEMA 6-15P input plug - a NEMA L6-15P rewirable twist lock plug is provided as an alternate.

3.0 Presentation

3.6 2000VA model - 220/230/240 Vac version

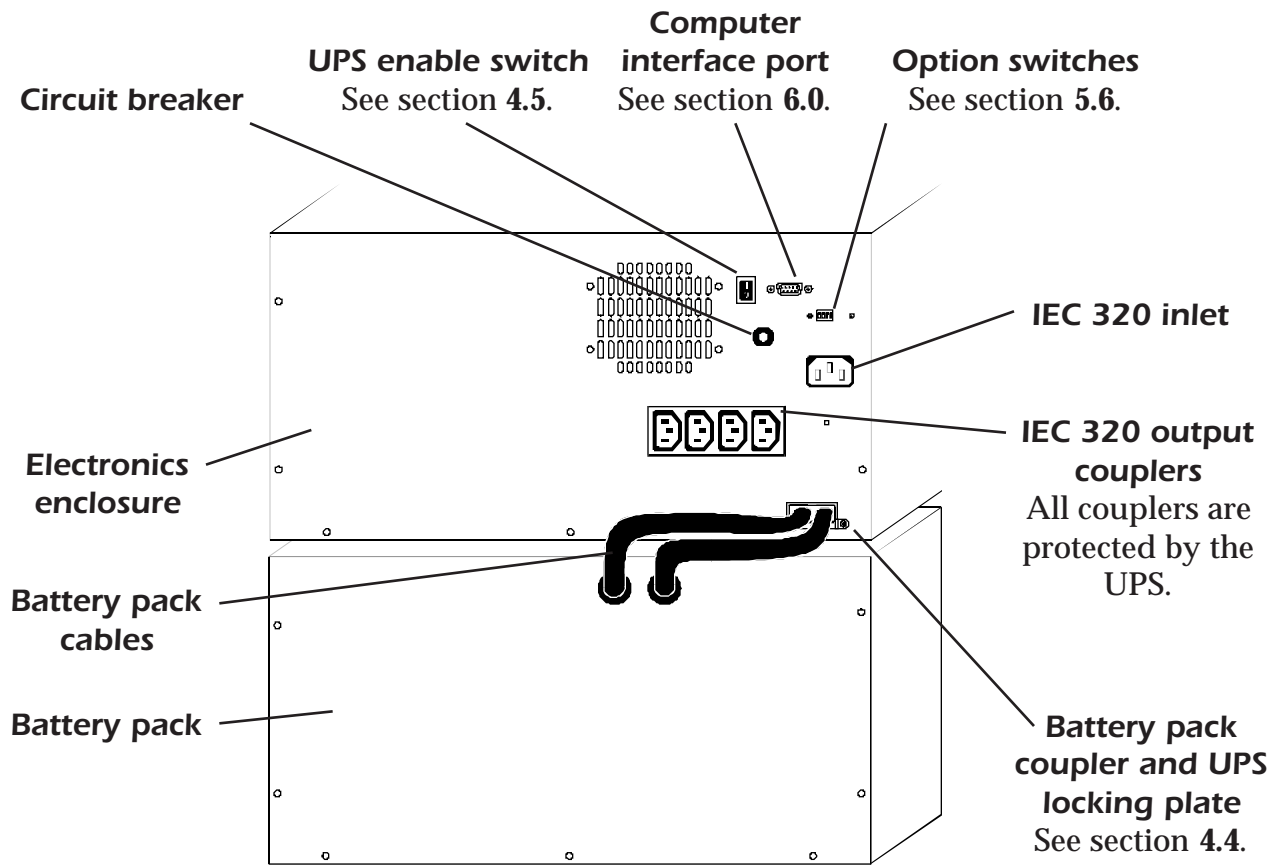
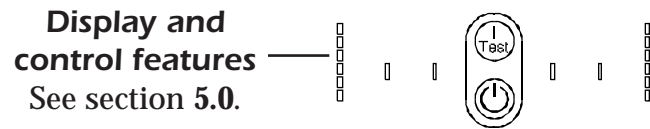

Rear view

4.0 Installation

4.1 Receiving inspection

Once the UPS has been removed from its shipping container, it should be inspected for damage that may have occurred while in transit. Immediately notify the carrier and place of purchase if any damage is found. The packing materials are made from recyclable materials and should be saved for reuse or disposed of properly.

4.2 Placement

The UPS may be installed in any protected environment. The location should provide adequate air flow around the unit, in an atmosphere free from excessive dust. Do not operate the UPS in an environment where the ambient temperature or humidity is outside the limits given in the **Specifications** section of this manual.

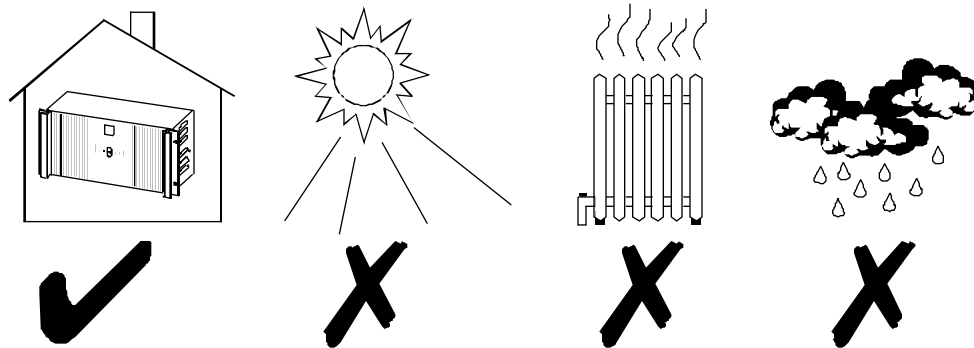

4.3 Attach handles, mount to equipment rack

Attach the UPS mounting handles as shown using the four #10-32 x 3/8" screws provided. The UPS may be mounted to any standard 19" equipment rack using the #10-32 clip nuts and ornamental screws provided. All four fasteners must be used. If the UPS is to be placed on a shelf, the four rubber feet provided may be applied to the bottom of the UPS to protect the shelf from scratches.

Note: Mount the UPS in a location where the fan exhaust openings will not be blocked.

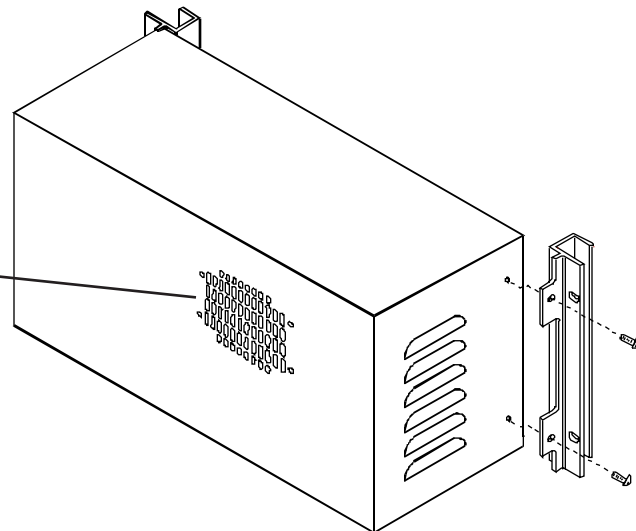

4.0 Installation

4.4 Connect battery pack - 900VA, 2000VA models

Follow the instructions listed below to install and lock the battery pack coupler.

Note: Use only factory supplied or authorized battery packs!

4.4.1 Use a phillips screwdriver to remove the battery coupler clamp from the electronics enclosure.

4.4.2 Turn the battery coupler clamp and refasten loosely at one side.

4.4.3 Mate the battery pack coupler to the electronics enclosure.

4.4.4 Fasten remaining side of battery coupler clamp to lock in place.

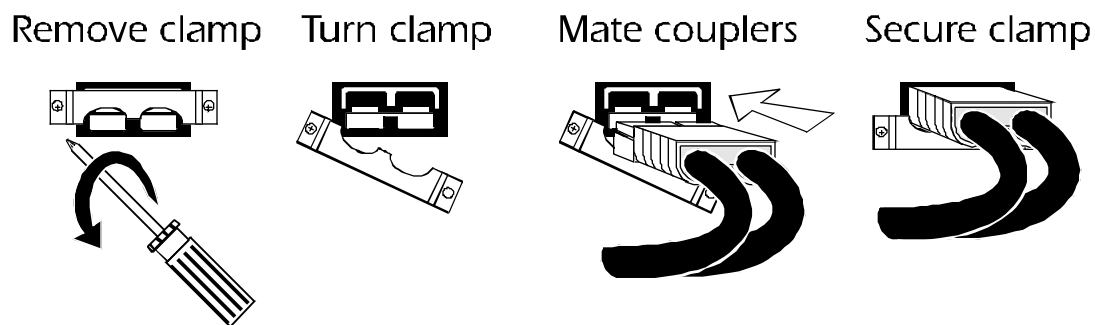

4.5 Connect UPS to service and enable

4.5.1 Connect UPS to service

■ 120 Vac versions

Plug the UPS into a two-pole, three wire grounding receptacle only. Avoid the use of extension cords and adapter plugs.

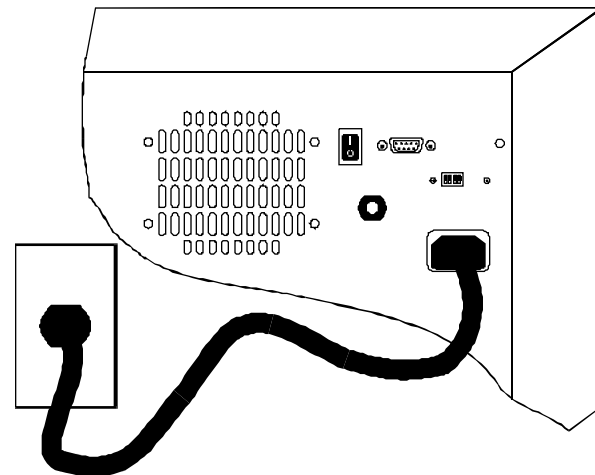

4.0 Installation

4.5 Connect UPS to service and enable - continued

■ 220/230/240 Vac versions

The 220/230/240 Vac version UPS is not furnished with an input line cord. Instead, two output cords are supplied. However, in most installations it will not be necessary to purchase a UPS input power cord. Simply swap the line cords from your equipment with the furnished output cords. Plug in the UPS using one of the swapped out equipment cords. The UPS's input cord must be three conductor, each 1.0 mm², rated to 10 Amps.

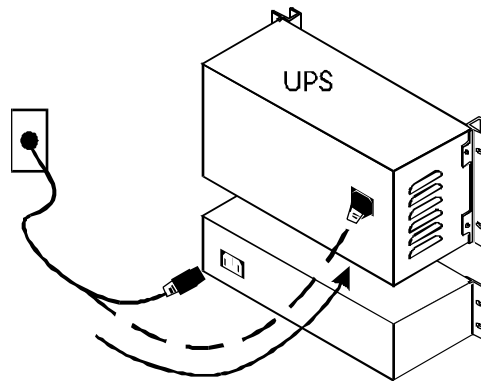

In the event your equipment does not have a removable line cord, the provided rewirable plug may be installed on the line cord. Additional output cords and adapter plugs are available from your dealer and from the factory.

The UPS may be configured to operate where 240 Vac, 50 Hz service is provided. When Option switch 2 is set to the on position, the UPS's transfer and on-battery output voltages are adjusted for proper operation on 240 Vac service. See section 5.6.

4.5.2 Enable UPS

Move the UPS Enable switch to the on (I) position. When shipped, this switch is in the off position to prevent accidental activation of the UPS. The batteries will not appreciably discharge if this switch is left on.

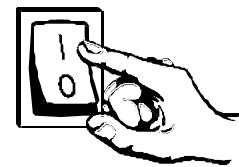

Allow the UPS to charge its battery for at least 8 hours before use. The UPS recharges its battery whenever the utility voltage is normal and UPS Enable switch is ON. While the UPS was shipped from the factory with the batteries in a fully charged state, the batteries may lose some charge during shipping and storage. You may use the UPS immediately without charging, but the Low Battery indicator may illuminate and the UPS may have reduced backup time until the battery has had an opportunity to charge.

4.0 Installation

4.6 Plug loads into UPS

Plug all loads to be protected into the UPS. Do not exceed the UPS's capacity as given in section 9.0. Once switched on, the UPS will monitor and display the magnitude of the applied load.

Note: Do not plug laser printers into this UPS. Laser printers draw a considerable amount of power. This will reduce the available backup time and in some cases will cause the UPS to signal an overload.

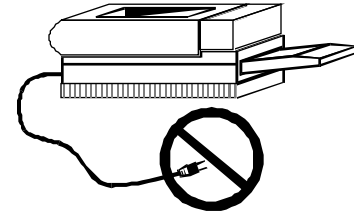

4.7 Check Site Wiring Fault indicator - 120 Vac versions

Once loads are connected to the UPS and the UPS is turned on, the Site Wiring Fault indicator at the UPS's rear panel should be checked. It will illuminate when the UPS is plugged into an improperly wired wall outlet. Wiring faults detected include missing ground, hot-neutral polarity reversal and overloaded neutral circuit.

Note: If the UPS indicates a site wiring fault, a qualified electrician should be summoned to correct the building wiring.



4.8 Switch on load equipment

If load equipment switches are left on, the UPS's I/Test pushbutton can be used as master system on/off switch.

4.9 Switch on the UPS

The UPS and your loads will become energized when the I/Test pushbutton is held pressed for a second. Once powered, the UPS will initiate a battery test. During the test, the UPS will operate the load from power derived from the battery. This test function ensures that the UPS is working properly and that its battery does not require replacement. In the event the batteries are too weak to support the load during the test, the UPS will immediately return to on-line operation (the load will not be affected). The test is completed when the On Line indicator ceases to blink.

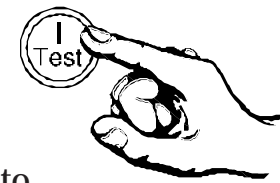

Note: If the red Load indicator is illuminated, the UPS is overloaded. Unplug equipment that does not require backing up, such as a printer, and restart the UPS. If the Replace Battery indicator illuminates, recharge the UPS overnight and retest.

5.0 Operation

5.1 Display features

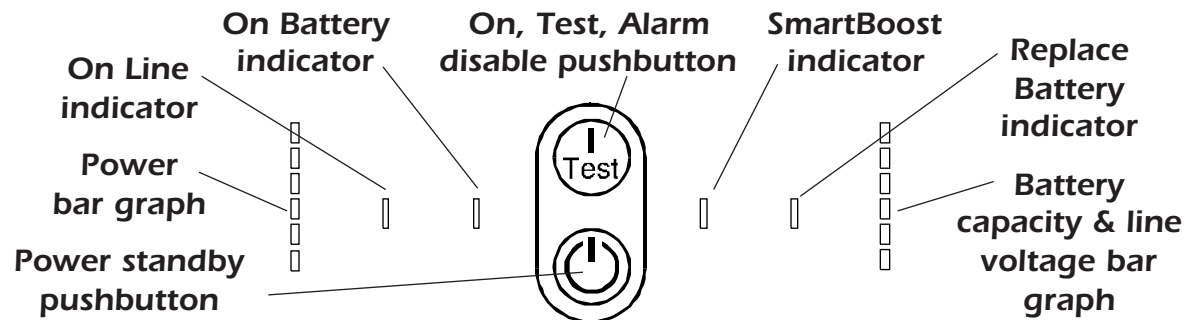

5.1.1 On / Test / Alarm disable pushbutton

The On / Test / Alarm disable pushbutton is used to control activation of the UPS and to energize the load. Once the UPS is energized, pressing the button will initiate a battery test. This will force the UPS to operate on-battery for a brief time during which the UPS determines the strength of the battery. When the UPS is on-battery, this button may be pressed to silence the utility failure audible warning.

5.1.2 Power standby pushbutton

When held pressed for a second, this control will deenergize the UPS and all protected loads. However, operation of the UPS's battery charger is unaffected by this control.

5.1.3 On Line indicator

Illumination of the On Line indicator means that the load is being supplied conditioned power derived from the utility service. The indicator blinks during the battery test.

5.1.4 On Battery indicator

Illumination of the On Battery indicator means that load has been transferred to power derived from the UPS's battery and that utility voltage is not within normal limits.

5.1.5 Smart Boost indicator

Illumination of SmartBoost indicator means that the SmartBoost circuitry has been engaged to compensate for unacceptably low line voltage. The UPS is capable of operating in this mode continuously without draining charge from the battery.

5.1.6 Replace Battery indicator

Illumination of the Replace Battery indicator means that the automatic battery test has found that the battery is weak and requires replacement. The indicator is extinguished following a successful battery test.

5.0 Operation

5.2 Battery capacity bar graph

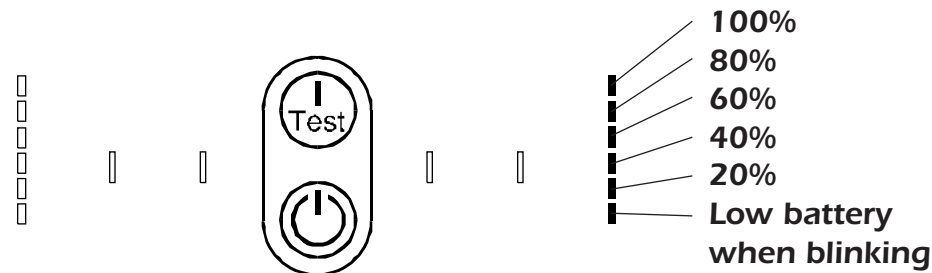

The battery capacity bar graph continuously displays the state of battery charge. In the above example, the display shows that 100% of rated battery capacity is available. Where power quality is fair, the UPS will be able to maintain the battery at 100% of rated capacity. In the event of an extended utility failure, the capacity shown will decrease at a rate dependent on the load drawn from the UPS. Large computer loads will cause the battery capacity indication to fall at a faster rate. When low battery conditions are reached, the bottom-most bar will blink. Once normal line voltages are restored, the UPS will recharge the battery and the capacity bar graph will show an increasing number of illuminated bars.

5.3 Output power bar graph

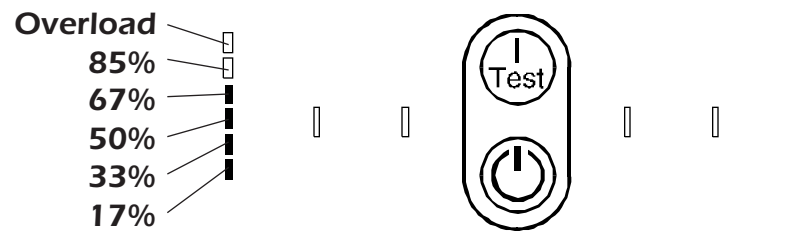

The output power bar graph displays the power drawn from the UPS as a percentage of the UPS's full rated capacity. This example shows that the load equipment is drawing between 67% and 85% of the UPS's rated capacity. If this were a 1250VA UPS running a computer load, then the above would correspond to between 840 VA and 1060 VA (590 Watts and 740 Watts at 0.7 power factor). This is a typical installation. When the UPS is loaded such that five bars are illuminated, thoroughly test your complete system to be sure the UPS will not become overloaded. A thorough test includes running backup tape drives, disk drives, etc. If the UPS becomes overloaded, the overload bar will illuminate and the UPS will sound an alarm.

5.0 Operation

5.4 Line voltage bar graph

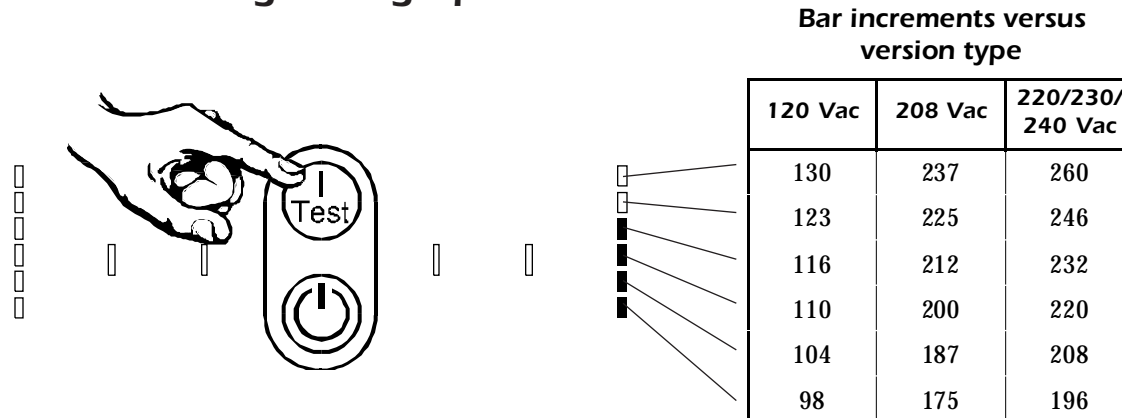

The line voltage bar graph displays the UPS's input voltage in discrete steps. Line voltage is displayed when the I/Test pushbutton is pressed and held. The example above shows that the UPS's input line voltage is between 116 and 123 Vac (120 Vac version UPS, see table for values for other versions). If no bars are illuminated, and the UPS is plugged into a known working wall outlet, the line voltage is extremely low. Low input voltage could be a result of an overloaded branch circuit, a misadjusted service pole transformer or intentional local service brownout. The UPS will compensate for this problem by boosting the load voltage supplied to your computer equipment. If all six bars are illuminated, the line voltage is high and should be checked by a qualified electrician.

5.5 Audible alarm

The UPS contains a beeper that emits sound through the ventilation openings. Events that cause the beeper to sound are listed below.

5.5.1 On-battery operation

The UPS emits four short beeps every 30 seconds following failure of the utility. The audible alarm is silenced until the next utility failure when the I/Test pushbutton is pressed.

5.5.2 Low battery

During an extended utility failure, the UPS will eventually emit continuous beeps to indicate that less than 2 minutes (or 5 minutes, see section 5.6) of run time remain before shut down due to battery capacity exhaustion. The low battery warning cannot be muted.

5.0 Operation

5.5.3 Replace battery

In the event the UPS's battery fails a battery test, the UPS will emit "chirps" for a period of 1 minute. If the UPS is left operating while in this condition, the UPS will emit chirps once every 5 hours until a successful battery test is completed.

5.5.4 Overload

The UPS will emit a loud, sustained tone when overloaded. When an overload is applied while on-line, the alarm will sound until the overload is removed. If the overload is applied while on-battery, the alarm will sound until the UPS Enable control is switched off.

5.6 Option switches

Note: Option switches may be thrown at any time and take effect immediately.

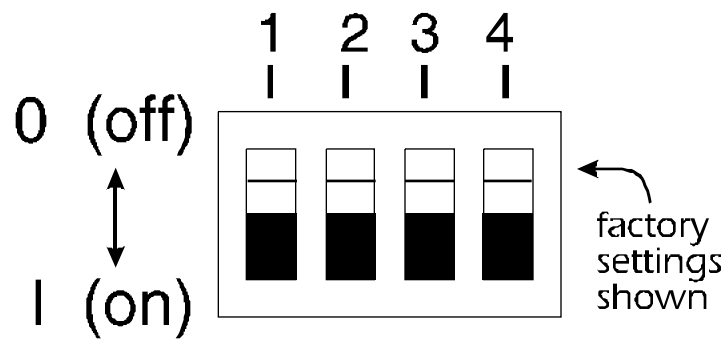

5.6.1 Option switch 1

The UPS contains utility fault detection circuitry that is extremely sensitive to line voltage distortions including spikes, notches, sudden dips and swells. The UPS is factory set to react to such line voltage distortions by transferring the load immediately to on-battery operation. This affords maximum protection for all load types. Where power quality is poor due to local cyclic heavy load switching or use of inexpensive fuel generators, the UPS may be caused to transfer to on-battery operation very often. If the UPS is powering loads that are known to operate normally under such conditions, such behavior is undesirable as battery capacity is being spent unnecessarily.

The user may set Option switch 1 to the on (1) position in order to desensitize the UPS to rapid low amplitude line voltage fluctuations. When this is done, the UPS's upper transfer voltage is also increased by 3%, for a total of 13% above the nominal input voltage. This allows the UPS's battery charger to maintain maximum possible battery capacity, saving it for gross utility failures.

5.0 Operation

5.6 Option switches - continued

5.6.2 Option switch 2

Option switch 2 controls different functions depending upon the UPS version type. The switch controls no functions on the 208 Vac version UPS.

■ 120 Vac version

The UPS's factory set input voltage limits for on-line and SmartBoost operation are given in section 9.0 and are centered on the nominal input voltage of 120 Vac. When Option switch 2 is set to the on (I) position, the upper and lower transfer voltages are lowered by 4% and are centered on a nominal input of 115 Vac. This option is useful where the nominal input voltage is 110 to 115 Vac.

■ 220/230/240 Vac version

The UPS's factory set on-battery output voltage and input voltage limits for on-line and SmartBoost operation are appropriate for use in regions where the nominal line voltage is 220 to 230 Vac. When Option switch 2 is set to the on (I) position, the upper and lower transfer voltages are raised by 4% and are centered on a nominal input of 240 Vac. In addition, the on-battery output voltage is increased to 240 Vac.

5.6.3 Option switch 3

When Option switch 3 is set to the on (I) position, the UPS's audible alarm is disabled for the first 30 seconds of an extended utility fault. This function is useful where brief power interruptions are frequent and cause the alarm to become annoying.

5.6.4 Option switch 4

When Option switch 4 is set to the on (I) position, the UPS's low battery warning interval before shutdown due to battery capacity exhaustion is extended from 2 minutes (factory setting) to 5 minutes. This function is useful where the UPS is protecting a computer system that requires longer than 2 minutes warning before power loss to perform a graceful shutdown.

5.0 Operation

5.7 Extended capabilities

The following sections briefly describe the UPS's extended capabilities. These advanced functions are accessed by a computer running optional PowerDoctor or PowerChute^{plus} UPS monitoring software. See the UPS monitoring software literature for more information on the application of these functions.

***Note:** The extended capabilities of the UPS and operation of UPS monitoring software may be altered or amended without notice.*

5.7.1 Status reporting

- **General** - When queried, the UPS reports its electronics serial number, version number, date of manufacture and date of last battery replacement.
- **Operating status** - When queried, the UPS reports its current operating status. Reported modes includes on-line, on-battery, Smart Boost, overloaded output, low battery, shut down and internal fault.
- **Test results** - When queried, the UPS reports the stored results of the last automatic or manually initiated battery test. The user may also test the operation of the UPS's visual and audible indicators.

5.7.2 Monitoring

- **Run time** - When on-battery, the UPS continuously monitors the remaining run time in minutes. Available run time is monitored when operating on-line.
- **Line voltage and frequency**- The UPS continuously monitors the rms line voltage and the line frequency. Transients lasting less than 0.5 seconds are not reported. This information can be logged using UPS monitoring software, plotted using any spreadsheet application and used to identify transient power quality problems over extended periods.
- **Minimum and maximum line voltage** - The minimum and maximum line voltage is recorded to provide a snapshot of power quality over a user specified interval. Transients lasting less than 0.5 seconds are not recorded.
- **Output power** - The UPS continuously monitors the power consumed by the load. The value given is a percentage of the full load rating of the UPS. This information can be logged using UPS monitoring software, plotted using any spreadsheet application and used to determine load usage over extended periods.

5.0 Operation

5.7 Extended capabilities - continued

● **Output voltage, internal temperature, battery voltage, battery capacity** - The UPS continuously monitors the rms output voltage, internal temperature in degrees Celsius, battery voltage, and the remaining battery capacity as a percentage of the fully charged condition. This information is valuable for troubleshooting purposes.

5.7.3 Power management

● **Shut down** - While operating on-battery, the UPS may be directed to shut down following a user set delay. Controlled shut down of the UPS conserves battery capacity and extends battery life because the UPS is not allowed to run until all battery capacity is exhausted.

● **Shut down with delayed restart** - The UPS may be directed to shut down in any mode following a user set delay, then restart after another user set delay. The restart delay may be used to stagger power up multiple network servers protected by multiple UPSs.

● **Simulate power failure** - The UPS may be directed to simulate a power failure by briefly operating on-battery. This function is useful for test purposes.

● **Turn off** - The UPS may be directed to turn off immediately or following a user settable delay.

5.7.4 Operation customizing

Alteration of many UPS operations is possible to suit specific applications. In order to use the customizing features of the UPS, all Option switches must be set to the on (I) position. Functionality of the option switches is not lost as all such functions are duplicated by the UPS monitoring software. Once any of the Option switches are returned to the off position, functionality governed by the position of all Option switches is also restored.

● **Battery test operation** - The battery test can be customized to automatically run upon startup, upon startup and once every 7 days thereafter, upon startup and once every 14 days thereafter, or never. The UPS's battery test operation default setting is upon start and every 14 days thereafter.

● **Transfer voltage** - The UPS's upper and lower transfer voltages can be customized over a wide range. Default settings are given in section 9.0.

5.0 Operation

5.7 Extended capabilities - continued

● **On-battery output voltage (220/230/240 Vac versions only)** - The UPS's on-battery output voltage may be set to a nominal 220, 225, 230 or 240 Vac. The UPS's default setting is 225 Vac.

● **Utility failure sensitivity** - The UPS's sensitivity to line voltage distortions may be customized to allow use of the UPS in "noisy" electrical environments or with fuel powered generators. High, medium and low sensitivity settings may be chosen. The high setting provides the best protection from all utility voltage vagaries. The medium setting is selected where rapid low amplitude line voltage fluctuations occur frequently as the result of motor load switching in air conditioners, elevators, etc. The low setting is selected when the UPS is operated from an inexpensive fuel powered generator. The UPS's utility failure sensitivity default setting is high.

● **Low battery warning interval** - The UPS's low battery warning may be customized to activate at a time 2, 5, 7 or 10 minutes prior to shut down. The UPS's low battery warning interval default setting is 2 minutes.

● **Audible alarm operation** - The UPS's audible alarm beeps four times every 30 seconds in response to failed utility conditions. The alarm beeps continuously when low battery conditions are reached. This is the default operation. Audible alarm operation may be customized such that an indication in response to utility failure is delayed by 30 seconds, silenced until low battery conditions are reached, or muted during both utility failure and low battery conditions.

● **Minimum battery capacity to restart** - The UPS may be customized so that it will not restart upon restoration of the utility until the battery has been recharged to within 0%, 10%, 25% or 90% of full capacity. This function eliminates unexpectedly short run times when repetitive utility failures occur. The UPS's minimum battery capacity to restart default setting is 0%.

● **Shut down, turn off delay** - The UPS's shut down or turn off delay interval may be customized to 20, 180, 300 or 600 seconds. The UPS's shut down delay default setting is 20 seconds. Extension of the shut delay is useful where the time between issuance of the UPS shut down command, and actual completion of the operating system shut-down routine is longer than 20 seconds.

● **Turn on delay** - The UPS's turn on delay may be customized to 0, 60, 180 or 300 seconds. The UPS's turn on delay default setting is 0 seconds.

6.0 UPS Monitoring

6.1 Overview

A UPS system alone provides excellent protection from brief power problems. However, during an extended power outage an unattended computer system will eventually shut down due to battery capacity exhaustion. To prevent data corruption when the UPS shuts down, the computer must be informed by the UPS of *impending* shut down and take appropriate file-saving measures. This important function is called “UPS monitoring.” The UPS’s computer interface port is the means by which your UPS communicates with a computer system.

Some computer operating systems have built-in UPS monitoring. These systems require various hardware interfaces. Interface kits for all operating systems that support UPS monitoring are available from your dealer. In addition, your dealer also offers PowerChute software which enhances such built-in UPS monitoring. Versions of PowerChute are available which add the UPS monitoring function to the many operating systems which do not inherently provide UPS monitoring.

6.2 Interface Kits

A series of interface kits is available for operating systems that provide UPS monitoring. Each interface kit includes the special interface cable required to convert status signals from the UPS into signals which individual operating systems recognize. Each kit includes all necessary installation instructions. Systems for which interface kits are offered include Novell, LAN Manager, LAN Server, LANtastic, Banyan VINES and IBM AS/400.

6.3 PowerChute Software

PowerChute software provides complete data protection for most operating systems. This software is a background process that monitors the UPS through a RS-232 serial port on the host. PowerChute offers user notification of impending shutdown, power event logging, auto-restart upon power return and UPS battery conservation features. For selected operating systems, PowerChute offers sophisticated power diagnostic and network power management features. These include interactive battery testing; scheduled server shutdowns, reboots and battery testing; detailed power quality logging and a remote, real time, graphical power status display showing UPS loading and battery conditions. PowerChute is available for many platforms including Novell, OS/2, AppleShare, XENIX, most UNIX-based operating systems, and DEC VAX/VMS.

Caution: Use only factory supplied or authorized UPS monitoring cables!

6.0 UPS Monitoring

6.4 Computer interface port

The computer interface port is diagramed below for your reference. Those with technical abilities wishing to use this port in a special application should be aware of the following limitations and capabilities of the interface.

■ Outputs at pins 3, 5 and 6 are actually open collector outputs which must be pulled up to a common referenced supply no greater than +40 Vdc. The transistors are capable of a maximum non-inductive load of 25 mAdc. Use only Pin 4 as the common.

■ The output at Pin 2 will generate a LO to HI RS-232 level upon transfer of the output load to power derived from the UPS's battery. The pin is normally at a LO RS-232 level.

■ The UPS will shut down when a HI RS-232 level, sustained for 4.5 s, is applied to Pin 1. The UPS responds to this signal, following a delay, only during mains failures (load is operating from the UPS's internal power source).

■ An unregulated +24 Vdc appears at Pin 8 of the interface port whenever the UPS is powered. The supply is limited to 40 mAdc maximum.

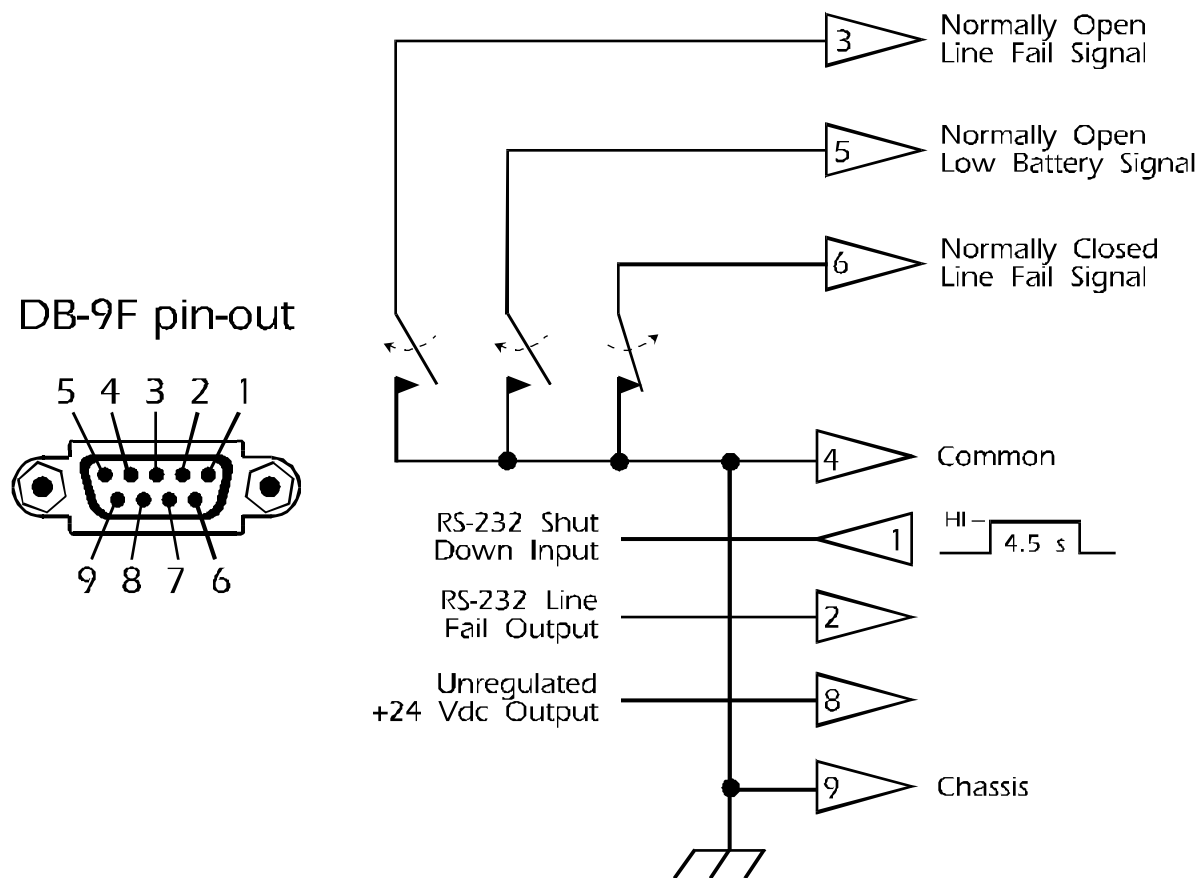

Caution !



CAUTION !

■ This Uninterruptible Power Source contains potentially hazardous voltages. Do not attempt to disassemble the unit. The unit contains no user serviceable parts. Repairs are performed only by factory trained service personnel.

■ This Uninterruptible Power Source uses batteries. The batteries will eventually become too weak to provide rated autonomous operation. Due to the potential health and environmental hazards posed by the batteries, they may be replaced only at factory authorized Service Centers. To obtain battery replacement or repair service, please call the Customer Service telephone number written on the cover of this manual for information on the Service Center nearest you.

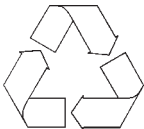

■ **The batteries used by this Uninterruptible Power Source are recyclable. Proper disposal of the batteries is required. The batteries contain lead and pose a hazard to the environment and human health if not disposed of properly. Please refer to local codes for proper disposal requirements or return the unit to a factory authorized Service Center for battery replacement or disposal.**

■ Battery replacement should be performed or supervised by personnel familiar with the danger of batteries and the required precautions. Keep unauthorized personnel away from batteries. When replacing batteries, use the same number and type of sealed lead acid batteries as were originally contained in your UPS.

■ **CAUTION** - Do not dispose of batteries in a fire. The batteries may explode.

■ **CAUTION** - Do not open or mutilate batteries. They contain an electrolyte which is toxic and harmful to the skin and eyes.

■ **CAUTION** - A battery can present a risk of electrical shock and high short circuit current. When replacing batteries, wrist watches and jewelry such as rings should be removed. Use tools with insulated handles.

Attention !



ATTENTION!

■ Cette source d'alimentation permanente (UPS) contient des circuits haute tension présentant un danger. Ne jamais essayer de le démonter. Il n'y a aucun composant qui puisse être réparé par l'utilisateur. Toutes les réparations doivent être effectuées par du personnel qualifié et agréé par le constructeur.

■ Cette source d'alimentation permanente (UPS) contient des accumulateurs. Ces accumulateurs deviendront un jour trop faibles pour pouvoir assurer un fonctionnement autonome correct. En raison des risques que posent les accumulateurs à la santé et à l'environnement, ils ne peuvent être remplacés que dans les Centres de Service agréés par le fabricant. Pour toute réparation ou remplacement des accumulateurs, composez le numéro du Service à la clientèle inscrit sur la couverture de ce manuel afin d'obtenir les coordonnées du Centre de Service le plus proche.

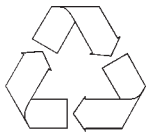

■ **Les accumulateurs contenus dans cette source d'alimentation sont recyclables. L'élimination des batteries est réglementée. Consulter les codes locaux à cet effet. Ils contiennent du plomb et représentent donc un risque pour l'homme et pour l'environnement si les règles de mise au rebut ne sont pas respectées. Veuillez retourner l'unité à un Centre de Service agréé lorsque vous désirerez remplacer ou vous débarrasser des accumulateurs usagés.**

■ **ATTENTION** - Pour le remplacement, utiliser le même nombre de batteries du modèle suivant: accumulateur au plomb.

■ **ATTENTION** - Une batterie peut présenter un risque de choc électrique, de brûlure par transfert d'énergie. Suivre les précautions qui s'imposent.

Vorsicht !



VORSICHT!

■ Im Inneren dieser unterbrechungsfreien Stromversorgung herrschen potentiell gefährliche Spannungen. Nicht versuchen, das Gerät zu öffnen. Es enthält keine vom Benutzer reparierbaren Teile. Reparaturen dürfen nur von ausgebildetem Kundendienstpersonal durchgeführt werden.

■ Diese unterbrechungsfreie Stromversorgung enthält Batterien, die nach einer bestimmten Zeit so schwach werden, daß der autonome Nennbetrieb nicht mehr gewährleistet ist. Aufgrund der potentiellen Gesundheits- und Umweltgefahren, die von den Batterien ausgehen, dürfen sie nur in einem vom Werk autorisierten Kundendienstzentrum ausgewechselt werden. Wenn die Batterien ausgewechselt werden müssen oder Reparaturen fällig sind, die auf der Umschlagseite dieser Gebrauchsanweisung angegebene Kundendienst-Telefonnummer anrufen. Dort teilt man Ihnen mit, welches Kundendienstzentrum für Sie zuständig ist.

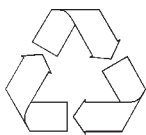

■ Die Batterien in dieser unterbrechungsfreien Stromversorgung sind wiederverwertbar. Sie sind bleihaltig und stellen eine Gefahr für die Umwelt und die Gesundheit dar, wenn sie nicht ordnungsgemäß entsorgt werden. Das Gerät an ein vom Werk autorisiertes Kundendienstzentrum einsenden, um die Batterien auszuwechseln oder entsorgen zu lassen.

¡Cuidado!



¡CUIDADO!

■ Esta Fuente de energía ininterrumpible contiene niveles de voltaje peligrosos en potencia. No intente desarmar la unidad, pues no contiene piezas que puedan ser reparadas por el usuario. Las reparaciones deben efectuarse únicamente por parte del personal de mantenimiento capacitado en la fábrica.

■ Esta Fuente de energía ininterrumpible contiene baterías. Con el tiempo las baterías se gastan demasiado para poder sustentar el funcionamiento autónomo a la capacidad nominal. Debido a que presentan un peligro potencial para la salud y el medio ambiente, las baterías pueden reemplazarse únicamente en los Centros de Servicio autorizados por la fábrica. Para solicitar el reemplazo de baterías o servicio de reparaciones, se ruega llamar al número telefónico de Atención a los Clientes indicado en la tapa de este manual y averiguar el Centro de Servicio más cercano.

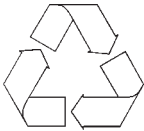

■ Las baterías que se encuentran en esta Fuente de energía ininterrumpible son reciclables. Las baterías contienen plomo y constituyen un peligro para el medio ambiente y para la salud de las personas si no se las desechan como corresponde. Se ruega devolver la unidad a un Centro de Servicio autorizado por la fábrica para el reemplazo o la eliminación de las baterías.

7.0 Difficulty

7.1 Troubleshooting chart

PROBLEM	POSSIBLE CAUSE	ACTION TO TAKE
UPS will not turn on.	1. UPS Enable switch is in the off position or front panel switch not pressed.	1. Turn on the rear panel UPS Enable switch. Press front panel switch to power UPS and loads.
	2. UPS's input circuit breaker is tripped (button is extended).	2. Reduce the UPS's load by unplugging equipment and reset the circuit breaker (press button on rear panel).
	3. Very low utility voltage or dead outlet.	3. Check outlet with a table lamp. If very dim, have utility voltage checked by an electrician.
UPS operates on-battery even though normal line voltage is thought to exist.	1. UPS's input circuit breaker is tripped (button is extended).	1. Reduce the UPS's load by unplugging equipment and reset the circuit breaker (press button on rear panel).
	2. Very high, low or badly distorted line voltage.	2. Test the input voltage with UPS's Line voltage bar graph - see section 5.0. Inexpensive fuel powered generators can cause distorted line voltages - set Option switch 1 to the on (I) position.
UPS "beeps" occasionally.	This is normal.	The UPS is protecting your computer equipment from momentary sags or swells.
UPS beeps more than once or twice an hour.	Chronically high or distorted line voltage.	Set Option switches 1 and 2 to match input voltage range. Alternatively, set Option switch 3 to the on (I) position - see section 5.0.
UPS does not provide expected back up time.	1. UPS's battery is weak due to recent utility outage or wear.	1. The UPS's batteries require recharging following an extended outage. The batteries will wear faster when put into service often and when operating at elevated temperatures.
	2. UPS is overloaded.	2. Check load using UPS's Output power bar graph - see section 5.0. Unplug non-critical equipment such as printers.
Indicators on front panel flash in a "marquee" fashion.	UPS has been shut down by computer software.	UPS will restart when AC power returns.
All indicators are illuminated and UPS emits constant tone.	Internal UPS fault.	Do not attempt to use UPS. Turn off UPS and have it serviced immediately.
Site wiring fault light is illuminated - UPS operates normally.	Building wiring error such as missing ground or hot-neutral reversal.	A qualified electrician should be summoned to correct the building wiring.
Low battery light is illuminated and on-line light is extinguished.	UPS is shut down and battery is discharged due to extended power failure.	UPS will return to normal operation when power is restored and battery has charged sufficiently.
Replace battery light is illuminated.	Weak battery.	Allow the batteries to recharge for at least 8 hours. If the problem persists after recharging, the batteries should be replaced.

7.0 Difficulty

7.2 Battery replacement check

You can expect to receive 3 to 6 years of service life from the UPS's batteries when installed in a cool, dry location. Battery life is shortened when operated in an environment where the ambient temperature is normally above 30°C (86°F).

The UPS automatically performs a battery test upon start up and, if left operating, every 14 days thereafter. This test actually loads the battery for a brief time and will detect a weak battery before it is put into service during a power failure. If the battery is too weak to support the load during this test, the UPS will instantly return to on-line operation. The UPS will illuminate the Replace Battery indicator when it is detected that the batteries can no longer sustain sufficient charge. This means that the UPS would be unable to provide power for longer than half the normal interval (see section 9.9) during an extended utility failure.

If the UPS illuminates the Replace Battery indicator, perform the following procedures to be sure that the batteries need replacing.

7.2.1 Use the UPS's Line voltage bar graph to check that the utility voltage is within a normal range. The UPS will charge the batteries at a slower rate when operated from very low input voltages. Where low line voltages and frequent disturbances are common, set the UPS's Option switch 1 to the on (I) position - see section 5.0.

7.2.2 Allow the UPS to charge the batteries for at least 8 hours following an extended utility failure.

7.2.3 Recheck the UPS's batteries by conducting a battery test. Press the I/Test button to initiate the battery test.

7.2.4 If the Replace Battery indicator does not illuminate following the battery test, the batteries do not require replacement. Extended storage without recharge, or successive power outages can cause false indications.

7.2.5 If the Replace Battery is illuminated following the battery test, the batteries are worn and need to be replaced.

7.2.6 Call the Customer Service phone number given on the cover of this manual to obtain information about battery replacement service or battery replacement kits.

Note: Please see the battery cautions at the beginning of this section.

7.0 Difficulty

7.3 Obtaining Service

The troubleshooting chart in section 7.1 covers most of the difficulties that a user may encounter under conditions other than a failure of the UPS itself. For problems not covered in the chart, the procedures outlined below should be followed.

If your UPS should require service:

- See the troubleshooting chart and eliminate the obvious. **A tripped UPS circuit breaker is the most common problem encountered and is user resettable once excessive loads are unplugged from the UPS.**
- If the circuit breaker is OK, note your UPS model, serial number and date of purchase. Contact the Customer Service Department at the phone number given on the cover of this booklet.
- Be prepared to provide a description of the problem. A technician will help you solve the problem over the phone if possible, or will give you a Return Material Authorization Number (RMA#).
- If the UPS is within the warranty period, repairs will be performed free of charge. If it is not within the warranty period, there will be a charge for repair.
- Pack the UPS in its original packaging. *If you no longer have the original shipping materials, ask the technician about obtaining a new set.* It is very important that you pack the UPS properly to avoid damage in transit. Never use styrofoam beads for packaging the UPS because it will settle through beads and become damaged. Damages sustained in transit are not covered under warranty. Enclose a letter in the package with your name, RMA#, address, copy of sales receipt, description of trouble, phone number and check (if necessary).
- Mark your RMA# on the outside of the package. *The factory cannot accept any package without this marking.*
- Return your UPS via insured, prepaid carrier to the address on the rear of this booklet.

8.0 Storing the UPS

8.1 Storage conditions

The UPS should be covered and stored upright in a cool dry location. The UPS should be stored with its battery in a fully charged state. That is, the indicated battery capacity should be 100% before the UPS is switched off for storage. Disconnect accessories or cables connected at the computer interface port as such devices may unnecessarily drain battery charge.

8.2 Extended storage

To achieve expected run time following extended storage, the UPS should be allowed to refresh its batteries every 6 months in environments where the ambient temperature is -15°C to +30°C (5°F to 86°F). For extended storage in environments where the ambient temperature is +30°C to +45°C (86°F to 113°F), the UPS should be allowed to refresh its batteries every 3 months.

9.0 Specifications

Note: Where specifications ratings differ, values for 208 Vac versions are given in () brackets, and values for 220/230/240 Vac versions are given in [] brackets.

9.1 Input

Nominal input voltage: single phase, 120 Vac, (208 Vac), [220/230/240 Vac].

Nominal input frequency: 50 or 60 Hz, internally selected by microprocessor.

Input protection, 600VA model: 8 Amp, [5 Amp] resettable circuit breaker.

Input protection, 900VA model: 14 Amp, [7 Amp] resettable circuit breaker.

Input protection, 1250VA model: 14 Amp, [12 Amp] resettable circuit breaker.

Input protection, 2000VA model: (14 Amp), [15 Amp] resettable circuit breaker.

9.2 Transfer characteristics

Frequency limits for on-line operation: 50 or 60 Hz, $\pm 5\%$.

Lower input voltage limit for on-line operation: 90 Vac, (150 Vac), [173 Vac; when set for operation on a 240 Vac line, the lower input voltage limit is increased to 180 Vac].

Upper input voltage limit for on-line operation: 132 Vac, (224 Vac), [253 Vac; when set for operation on a 240 Vac line, the upper input voltage limit is increased to 264 Vac].

SmartBoost operation input voltage range: 90 to 103 Vac, (150 to 172 Vac), [173 to 196 Vac; when set for operation on a 240 Vac line, the SmartBoost input voltage range is increased to 180 to 204 Vac].

Transfer time: 2 ms typical, 4 ms maximum. Note that 1 ms is 0.001 seconds.

9.3 Output characteristics

Maximum load, 600VA model: 600 VA or 400 W @ 0.67 power factor.

Maximum load, 900VA model: 900 VA or 630 W @ 0.70 power factor.

Maximum load, 1250VA model: 1250 VA or 900 W @ 0.7 power factor.

Maximum load, 2000VA model - 120 Vac version: 2000 VA or 1500 W @ 0.75 power factor with supplied NEMA L5-30P installed; 1850 VA or 1500 W @ 0.81 power factor with supplied NEMA 5-20P installed; 1440 VA or 1440 W as supplied. See section 3.0 for maximum load ratings of models with wiring device options.

Maximum load, 2000VA model - 208, 220/230/240 Vac versions: 2000 VA or 1500 W @ 0.75 power factor.

On-battery output voltage: 115 Vac, (208 Vac), [225 Vac] $\pm 5\%$. The 220/230/240 Vac version may be set to provide a nominal 240 Vac, see section 5.0.

On-battery frequency: 50 or 60 Hz, ± 0.1 Hz unless synchronized to mains frequency during utility brownout.

On-battery waveshape: low distortion sinewave.

Protection: overcurrent and short circuit protected, latching shutdown upon overload.

9.0 Specifications

9.4 Noise and surge suppression

Surge energy rating (one time, 10/1000 μ s waveform): 480 J.

Surge current capability (one time, 8/20 μ s waveform): 6500 Amp peak maximum.

Surge response time: 0 ns (instantaneous) normal mode, <5 ns common mode.

Surge voltage let-through: <0.3%, (<2%), [<2%] of applied ANSI C62.41 Category A \pm 6 kV test waveform.

Noise filter: normal and common mode EMI/RFI suppression, 100 kHz to 10 MHz.

9.5 Battery and charger

Battery type: spill proof, maintenance free sealed lead-calcium.

Typical battery life: 3 to 6 years - depends on number of discharge cycles and ambient temperature.

Typical recharge time: 4 to 10 hours from total discharge. See section 9.9 for recharge time with 900VA extended run model. UPS may be used immediately after discharge but will provide shorter run time.

9.6 Environment

Operating temperature: 0°C to 40°C (32°F to 104°F).

Storage temperature: -15°C to 45°C (5°F to 113°F).

Operating and storage relative humidity: 0 to 95%, non-condensing.

Operating elevation: 0 to 3,000 m (10,000 ft).

Storage elevation: 0 to 15,000 m (50,000 ft).

Electromagnetic immunity: IEC 801-2, 801-3, 801-4, 801-5; severity levels III or IV.

Audible noise, 600VA model: < 45 dBA at 1 m (3 ft).

Audible noise, 900VA, 1250VA, 2000VA models: < 50 dBA at 1 m (3 ft).

9.7 Physical

Size, 600VA, 900VA, 1250VA models: 8.7"H x 19.0"W x 7.3"D (22.1 x 48.3 x 18.4 cm).

Size, 2000VA model: two enclosures each 8.7"H x 19.0"W x 7.3"D (22.1 x 48.3 x 18.4 cm).

Weight, 600VA model: 38 lbs (17.2 kg), shipping weight is 43 lbs (19.5 kg).

Weight, 900VA model: Electronics enclosure is 37 lbs (16.8 kg), shipping weight is 42 lbs (19.1 kg). The Battery pack is 65 lbs (29.5 kg), shipping weight is 70 lbs (31.8 kg).

Weight, 1250VA model: 59 lbs (26.8 kg), shipping weight is 64 lbs (29.0 kg).

Weight, 2000VA model: Electronics enclosure is 43 lbs (19.5 kg), shipping weight is 48 lbs (21.8 kg). The Battery pack is 65 lbs (29.5 kg), shipping weight is 70 lbs (31.8 kg).

9.8 Approvals

Safety approvals: UL per 1778, CSA per C22.2, TUV per IEC 950.

EMC verification: FCC, DOC Class A verified; EN55022 Class A verified.

9.0 Specifications

9.9 Typical run time versus load

9.9.1 600VA, 1250VA, 2000VA models

Load	600VA model	1250VA model	2000VA model	Typical computer load (0.7 volt-amps = Watts)
50 VA	140 min	290 min	450 min	Typical ASCII terminal
75 VA	113 min	250 min	400 min	Macintosh SE/30
100 VA	85 min	210 min	350 min	IBM PS/2 30 w/ monochrome monitor
150 VA	55 min	160 min	280 min	IBM PS/2 30 with VGA monitor
200 VA	38 min	120 min	220 min	IBM PS/2 55sx with VGA monitor
250 VA	26 min	90 min	180 min	Compaq 386/25e with VGA monitor
300 VA	20 min	70 min	145 min	Compaq 386/33 with VGA monitor
350 VA	17 min	50 min	109 min	IBM PS/2 80 file server
400 VA	14 min	38 min	88 min	Compaq 386/33 with 19" monitor
450 VA	11 min	32 min	70 min	Compaq 486/33 with 19" monitor
500 VA	9 min	27 min	55 min	Compaq Systempro server
550 VA	7.5 min	24 min	45 min	(2) Compaq 386/25e w/ VGA monitors
600 VA	6 min	22 min	40 min	(2) Compaq 386/33 with VGA monitors
700 VA		17 min	35 min	(2) IBM PS/2 80 file servers
800 VA		14 min	29 min	IBM AS/400 B20 minicomputer
900 VA		12 min	25 min	DEC MicroVax
1000 VA		10 min	22 min	(2) Compaq Systempro servers
1200 VA		7 min	17 min	(4) Compaq 386/33 w/ VGA monitors
1400 VA			14 min	
1600 VA			11 min	(8) IBM PS/2 55sx w/ VGA monitors
2000 VA			8 min	(4) Compaq Systempro servers

Note: Run times are typical at 25°C (77°F).

9.9.2 Typical recharge time and run time versus load - 900VA model.

Number Of Battery Packs	1	2	3	4	5	6	7	8	9	10	* recharge to 90% of capacity subsequent discharge into 50% of rated load
	3.7 hr	6.4 hr	9.1 hr	11.8 hr	14.6 hr	17.4 hr	20.2 hr	23.0 hr	25.8 hr	28.6 hr	
Computer Load (Volt-Amps)	Typical computer load (p.f. typically 0.6 to 0.7)										
50 VA	13.0 hr	30.6 hr	45.9 hr	61.2 hr	76.5 hr	91.8 hr	107.1 hr	122.4 hr	137.7 hr	153.0 hr	Typical ASCII terminal
75 VA	9.6 hr	23.6 hr	36.3 hr	48.4 hr	60.5 hr	72.7 hr	84.8 hr	96.9 hr	109.0 hr	121.1 hr	Macintosh SE/30
100 VA	7.8 hr	18.6 hr	30.0 hr	40.0 hr	50.0 hr	60.0 hr	70.0 hr	80.1 hr	90.1 hr	100.1 hr	IBM PS/2 30 w/ monochrome
150 VA	5.5 hr	12.4 hr	21.2 hr	29.6 hr	37.0 hr	44.4 hr	51.9 hr	59.3 hr	66.7 hr	74.1 hr	IBM PS/2 30 w/ VGA monitor
200 VA	4.3 hr	9.3 hr	15.7 hr	22.7 hr	29.3 hr	35.2 hr	41.1 hr	46.9 hr	52.8 hr	58.6 hr	IBM PS/2 55sx w/ VGA monitor
250 VA	3.5 hr	7.5 hr	12.1 hr	17.8 hr	23.6 hr	29.1 hr	33.9 hr	38.7 hr	43.6 hr	48.4 hr	Compaq 386/25e w/ VGA monitor
300 VA	2.9 hr	6.2 hr	9.8 hr	14.4 hr	19.3 hr	24.2 hr	28.8 hr	32.9 hr	37.0 hr	41.1 hr	Compaq 386/33 w/ VGA monitor
350 VA	2.5 hr	5.3 hr	8.4 hr	11.8 hr	16.0 hr	20.3 hr	24.5 hr	28.6 hr	32.1 hr	35.7 hr	IBM PS/2 95 file server
400 VA	2.2 hr	4.7 hr	7.3 hr	10.0 hr	13.5 hr	17.3 hr	21.0 hr	24.8 hr	28.4 hr	31.5 hr	Compaq 386/33 w/ 19" monitor
450 VA	1.9 hr	4.1 hr	6.4 hr	8.9 hr	11.5 hr	14.9 hr	18.2 hr	21.6 hr	24.9 hr	28.1 hr	Compaq 486/33 w/ 19" monitor
500 VA	1.7 hr	3.7 hr	5.7 hr	7.9 hr	10.1 hr	12.9 hr	16.0 hr	19.0 hr	22.0 hr	25.0 hr	Compaq Systempro server
550 VA	1.5 hr	3.3 hr	5.2 hr	7.1 hr	9.1 hr	11.3 hr	14.1 hr	16.8 hr	19.6 hr	22.3 hr	(2) Compaq 386/25e w/ monitors
600 VA	1.4 hr	3.0 hr	4.7 hr	6.4 hr	8.3 hr	10.1 hr	12.4 hr	15.0 hr	17.5 hr	20.0 hr	(2) Compaq 386/33 w/ monitors
700 VA	1.1 hr	2.5 hr	4.0 hr	5.4 hr	7.0 hr	8.5 hr	10.1 hr	12.0 hr	14.2 hr	16.4 hr	(2) IBM PS/2 95 file servers
800 VA	0.9 hr	2.2 hr	3.4 hr	4.7 hr	5.9 hr	7.3 hr	8.7 hr	10.0 hr	11.7 hr	13.6 hr	IBM AS/400 D20 minicomputer
900 VA	0.8 hr	1.9 hr	3.0 hr	4.1 hr	5.2 hr	6.3 hr	7.6 hr	8.8 hr	10.0 hr	11.4 hr	DEC MicroVax

Note: Run times are typical at 25°C (77°F).

DECLARATION OF CONFORMITY

Application of Council Directive(s): 89/336/EEC

Standard(s) to which Conformity is Declared: EN55022, EN50082-1

Manufacturer's Name: AMERICAN POWER CONVERSION

Manufacturer's Address: 132 FAIRGROUNDS ROAD

WEST KINGSTON, RI 02892 USA

Importer's Name: _____

Importer's Address: _____

Type of Equipment: UNINTERRUPTIBLE POWER SOURCE

Model No.: SMART-UPS 600RM, 900XLRM, 1250RM, 2000RM

INCLUDING OPTIONS -1, -2, -3, -4

Serial Number: S930100001-S931299999, S940100001-S941299999

Year of Manufacture: 1993, 1994

I, the undersigned, hereby declare that the equipment specified above conforms to the above Directives(s).

Place: BILLERICA, MA USA

(Signature)

Date: 11/1/93

Joseph Pomata

(Full name)

Regulatory Compliance Engineer

(Position)

Limited Warranty

American Power Conversion (APC) warrants its products to be free from defects in materials and workmanship for a period of two years from the date of purchase. Its obligation under this warranty is limited to repairing or replacing, at its own sole option, any such defective products. To obtain service under warranty you must obtain a Returned Material Authorization (RMA) number from APC or an APC service center. Products must be returned to APC or an APC service center with transportation charges prepaid and must be accompanied by a brief description of the problem encountered and proof of date and place of purchase. This warranty does not apply to equipment which has been damaged by accident, negligence, or mis-application or has been altered or modified in any way. This warranty applies only to the original purchaser who must have properly registered the product within 10 days of purchase.

EXCEPT AS PROVIDED HEREIN, AMERICAN POWER CONVERSION MAKES NO WARRANTIES, EXPRESS OR IMPLIED, INCLUDING WARRANTIES OF MERCHANTABILITY AND FITNESS FOR A PARTICULAR PURPOSE. Some states do not permit limitation or exclusion of implied warranties; therefore, the aforesaid limitation(s) or exclusion(s) may not apply to the purchaser.

EXCEPT AS PROVIDED ABOVE, IN NO EVENT WILL APC BE LIABLE FOR DIRECT, INDIRECT, SPECIAL, INCIDENTAL, OR CONSEQUENTIAL DAMAGES ARISING OUT OF THE USE OF THIS PRODUCT, EVEN IF ADVISED OF THE POSSIBILITY OF SUCH DAMAGE. Specifically, APC is not liable for any costs, such as lost profits or revenue, loss of equipment, loss of use of equipment, loss of software, loss of data, costs of substitutes, claims by third parties, or otherwise. This warranty gives you specific legal rights and you may also have other rights which vary from state to state.

Life support policy

As a general policy, American Power Conversion (APC) does not recommend the use of any of its products in life support applications where failure or malfunction of the APC product can be reasonably expected to cause failure of the life support device or to significantly affect its safety or effectiveness. APC does not recommend the use of any of its products in direct patient care. APC will not knowingly sell its products for use in such applications unless it receives in writing assurances satisfactory to APC that (a) the risks of injury or damage have been minimized, (b) the customer assumes all such risks, and (c) the liability of American Power Conversion is adequately protected under the circumstances.

Examples of devices considered to be life support devices are neonatal oxygen analyzers, nerve stimulators (whether used for anesthesia, pain relief, or other purposes), autotransfusion devices, blood pumps, defibrillators, arrhythmia detectors and alarms, pacemakers, hemodialysis systems, peritoneal dialysis systems, neonatal ventilator incubators, ventilators for both adults and infants, anesthesia ventilators, and infusion pumps as well as any other devices designated as “critical” by the U.S. FDA.

Hospital grade wiring devices and leakage current may be ordered as options on many APC UPS systems. APC does not claim that units with this modification are certified or listed as Hospital Grade by APC or any other organization. Therefore these units do not meet the requirements for use in direct patient care.



AMERICAN POWER CONVERSION

PHONE

(800) 800-4272 in USA, Canada
(401) 789-5735 world wide

PHONE

(+33) 1.64.62.59.00 in Europe
(401) 789-5735 world wide

MAILING

American Power Conversion
132 Fairgrounds Road
P.O. Box 278
West Kingston, Rhode Island
02892 USA

MAILING

American Power Conversion
4, rue Ste Claire Deville
Zac du Mandinet-Bâtiment Espace
LOGNES
77447 MARNE LA VALLEE Cédex 2
FRANCE

Note: *The troubleshooting chart in section 7.0 offers solutions for most of the difficulties you may encounter with this UPS. Before calling the customer service number, please have available your UPS's serial number (see the label at the rear of the UPS).*

Serial number: _____
