



PHILIPS

P 2000 C

SYSTEM REFERENCE AND SERVICE MANUAL

First reprint week 417 (incorporating AL 1)

p-System is a trademark of Softech Microsystems

CP/M is a trademark of Digital Research Inc., Pacific Grove, Cal.

IMPORTANT NOTE:

This software program is distributed on an
'as is' basis without any warranty or liability.

COPYRIGHT BY PHILIPS, 1984, all rights reserved.

5103 993 30422

Philips Portable Computer

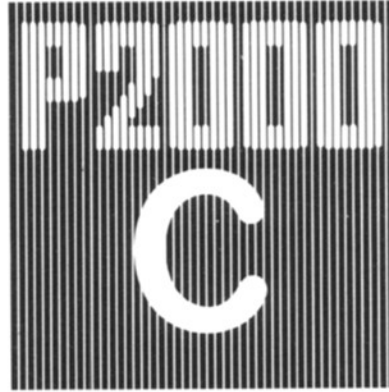

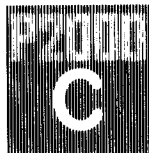

Contents

TABLE OF CONTENTS

		page
	PREFACE	iii
	PAGE LAYOUT	iv
	TABLE OF CONTENTS	v
	LIST OF ILLUSTRATIONS	xv
	LIST OF TABLES	xvii
PART 1		
INTRODUCTION		
1	Introduction	1.1 1-1
2	Related Documents	1-3
PART 2		
OPERATING SYSTEMS & GENERAL CONCEPTS		
CHAPTER 1 - OPERATING SYSTEMS		
	CP/M*	2.1 1-1
1	GENERAL	1-1
	p-System**	2.1 2-1
1	GENERAL	2-1
	BASIC I/O SYSTEM (BIOS)	2.1 3-1
1	GENERAL	3-1
2	INITIAL PROGRAM LOAD	3-1
2.1	Port Initialisation	3-1
2.2	Transfer Device Drivers to RAM	3-2
2.3	Initial Handshake with Terminalboard	3-2
2.4	Compute ROM Checksum	3-2
2.5	Initialise the Floppy Controller	3-3
2.6	Load System Track from Floppy or Hard Disk	3-3
3	DRIVERS FOR THE PERIPHERAL DEVICES	3-4
3.1	Driver Jumping Table	3-5
	3.1.1 Console Status	3-5
	3.1.2 Console Input	3-5
	3.1.3 Console Output	3-6
	3.1.4 List (Printer) Output	3-6
	3.1.5 Communication (Punch) Output	3-7
	3.1.6 Communication (Punch) Input	3-7

* Trademark of Digital Research Inc.

** Trademark of Softech Micro Systems

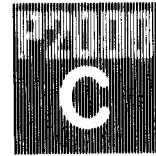

3.2	Routines Defined by the Driver Parameter Block (DPB)	3-8
3.2.1	Read One or More Sectors from Disk	3-8
3.2.2	Write One or More Sectors to Disk	3-10
3.2.3	Step to a Track	3-10
3.2.4	Recalibrate Drive	3-10
3.2.5	Boot System Track(s) from the Selected Drive	3-11
3.2.6	Get Listening Device Status	3-11
3.2.7	Print Screen	3-11
3.3	System Timer	3-12
3.4	Summary of the Driver Parameter Table	3-12
3.5	Interrupt Vector Table	3-13
*		
4	CP/M INITIALISATION	3-14
	TERMINALBOARD FIRMWARE	2.1 4-1
1	GENERAL	4-1
1.1	Memory Layout	4-1
1.2	Features	4-2
1.2.1	Communication	4-2
1.2.2	Keyboard	4-2
1.2.3	Screen	4-2
2	DETAILED DESCRIPTION	4-3
2.1	Communication	4-3
2.1.1	Transfer - CPU to Terminal	4-3
2.1.2	Transfer - Terminal to CPU	4-3
2.2	Keyboard	4-4
2.3	Screen and Screen Codes	4-4
2.3.1	Single Codes	4-4
	Control Code (CTRL) Generation	4-5
2.3.2	Escape Sequence - Set Attribute	4-7
2.3.3	Escape Sequence - Screen Control	4-8
2.3.4	Description of Control Codes	4-9
2.3.5	Graphic Control	4-14
2.3.6	Description of Graphic Commands	4-17
2.3.7	Example - Basic Program Using Polar Co-ordinates	4-18
2.3.8	Description of Graphic RAM	4-18
2.4	Status Information	4-20



CHAPTER 2 - HARDWARE CONFIGURATION AND PERIPHERAL EXTENSIONS

	HARDWARE	2.2	1-1
1	HARDWARE CONFIGURATION		1-1
1.1	Installation		1-1
	1.1.1 Connecting the Mains Supply		1-2
	1.1.2 Earthing		1-2
	1.1.3 Adjustment of Power Supply		1-2
1.2	Mechanical Construction		1-3
	1.2.1 Dimensions of System Components		1-4
	1.2.2 Cable Specifications and Lengths		1-4
1.3	Safety		1-5
1.4	Environmental Conditions		1-6
	1.4.1 Conditions for Storage of Components		1-6
	1.4.2 Transportation Constraints		1-6
	1.4.3 Conditions for Operation of Units		1-7
	1.4.4 Electromagnetic Constraints		1-8
	1.4.5 Electrostatic Constraints		1-8
	1.4.6 Positioning of P2000C		1-8

PART 3
DETAILED DESCRIPTION AND SERVICING

INTRODUCTION

1	GENERAL	3.1	0-1
2	P2000C 12NC Numbers		0-2
2.1	Example		0-2
2.2	Service Sticker		0-3

CHAPTER 1 - POWER SUPPLY

1	GENERAL	3.1	1-1
2	SPECIFICATION		1-1
3	SAFETY PRECAUTIONS		1-2
3.1	Mains Input Plug		1-2
3.2	High Voltage Warning		1-2
4	INPUT VOLTAGE SELECTION		1-3

CHAPTER 2 - MAINBOARD

	INTRODUCTION	3.2	1-1
1	GENERAL		1-1
2	SIGNALS		1-2
2.1	External Signals		1-2
2.2	Mainboard Bus Signals		1-4

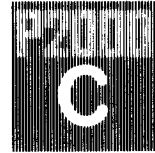

	CPU	3.2	2-1
1	GENERAL		2-1
2	BLOCK DIAGRAM		2-2
3	CIRCUIT DESCRIPTION		2-3
3.1	Data Bus and Address Bus		2-3
3.2	Control Bus		2-3
3.3	Additional Signals		2-4
	DMA	3.2	3-1
1	GENERAL		3-1
2	BLOCK DIAGRAM		3-2
3	CIRCUIT DESCRIPTION		3-3
3.1	Data Transfer		3-3
3.2	Multiplexed Address/Data Bus		3-4
3.3	Software Considerations		3-4
	DATA BUFFERS	3.2	4-1
1	GENERAL		4-1
2	BLOCK DIAGRAM		4-1
3	CIRCUIT DESCRIPTION		4-2
3.1	Internal Data Bus - Loading		4-2
3.2	I/O Data Bus - Loading		4-3
	CLOCK GENERATOR	3.2	5-1
1	GENERAL		5-1
2	BLOCK DIAGRAM		5-1
3	CIRCUIT DESCRIPTION		5-2
	I/O DECODER	3.2	6-1
1	GENERAL		6-1
2	BLOCK DIAGRAM		6-1
3	CIRCUIT DESCRIPTION		6-2
3.1	Mainboard I/O Addresses		6-4
	MEMORY MANAGER	3.2	7-1
1	GENERAL		7-1
2	BLOCK DIAGRAM		7-1
3	CIRCUIT DESCRIPTION		7-2
	RANDOM ACCESS MEMORY	3.2	8-1
1	GENERAL		8-1
2	BLOCK DIAGRAM		8-2
3	CIRCUIT DESCRIPTION		8-3
	IPL ROM	3.2	9-1
1	GENERAL		9-1
2	BLOCK DIAGRAM		9-1
3	PINNING		9-2
4	JUMPER J21		9-2
5	FUNCTION OF IPL		9-2

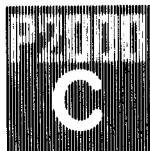

	S A S INTERFACE	3.2	10-1
1	GENERAL		10-1
2	BLOCK DIAGRAM		10-1
3	CIRCUIT DESCRIPTION		10-2
3.1	Description of a Data Transfer		10-2
3.2	Driver Current Requirements		10-3
3.3	Control		10-4
3.4	I/O Addresses		10-4
	FLEXIBLE DISK CONTROLLER	3.2	11-1
1	GENERAL		11-1
1.1	uPD 765 Disk Controller - General		11-1
1.2	Application in P2000C		11-2
1.3	Flexible Disk Controller Technology		11-2
2	BLOCK DIAGRAM		11-2
3	CIRCUIT DESCRIPTION		11-3
3.1	Integrated Circuits		11-3
3.2	Flexible Disk Controller Hardware Interface		11-4
3.3	Flexible Disk Controller Software Interface		11-5
3.4	Adjustment of VCO Middle Frequency		11-5
4	TIMING DIAGRAMS		11-5
	BAUD RATE GENERATOR - CTC	3.2	12-1
1	GENERAL		12-1
2	BLOCK DIAGRAM		12-2
3	CIRCUIT DESCRIPTION		12-3
3.1	CTC 1		12-3
3.2	CTC 2		12-3
3.3	Baud Rate Relationships		12-4
	SERIAL INTERFACE	3.2	13-1
1	GENERAL		13-1
1.1	Z80A SIO - Z8440		13-1
1.2	USART - 8251A		13-5
2	BLOCK DIAGRAM		13-6
3	CIRCUIT DESCRIPTION		13-7
3.1	General		13-7
3.2	Baudrate Selection		13-7
	3.2.1 Maximum Baudrates		13-8
3.3	Terminal Interface		13-8
	3.3.1 Baudrate Generator		13-9
3.4	Communication Interface		13-9
	3.4.1 Baudrate Generator		13-9
	3.4.2 Jumper J20		13-10
3.5	Printer Interface		13-10
	3.5.1 Baudrate Generator		13-10
3.6	Connection - Mainboard to Terminal Board		13-11
3.7	Jumpers		13-11
	3.7.1 D-Device Plugs		13-11
	3.7.2 Baudrate Selection		13-11
	3.7.3 Jumpers - Physical Connections		13-13

x



	BUS EXTENSION	3.2	14-1
1	GENERAL		14-1

CHAPTER 3 - TERMINAL BOARD

	INTRODUCTION	3.3	1-1
1	GENERAL		1-1
	CPU	3.3	2-1
1	GENERAL		2-1
2	BLOCK DIAGRAM		2-1
3	CIRCUIT DESCRIPTION		2-2
3.1	Address Decoding		2-2
3.2	Reset		2-2
3.3	Interrupt Mode		2-2
	CRT CONTROLLER	3.3	3-1
1	GENERAL		3-1
2	BLOCK DIAGRAM		3-2
3	CIRCUIT DESCRIPTION		3-3
3.1	Communication Between Z80 and 6845		3-3
	TIMING	3.3	4-1
1	GENERAL		4-1
2	BLOCK DIAGRAM		4-2
3	CIRCUIT DESCRIPTION		4-3
3.1	Delay Line		4-3
	RAM BANKS	3.3	5-1
1	GENERAL		5-1
2	BLOCK DIAGRAM		5-2
3	CIRCUIT DESCRIPTION		5-3
3.1	RAM Bank0 - Video Refresh Memory		5-3
	3.1.1 Jumper J6		5-3
3.2	RAM Bank1 - Attribute Memory		5-3
	3.2.1 Attributes		5-3
	3.2.2 Graphic Memory		5-4
	ADDRESS MULTIPLEXER	3.3	6-1
1	GENERAL		6-1
2	BLOCK DIAGRAM		6-1
3	CIRCUIT DESCRIPTION		6-2

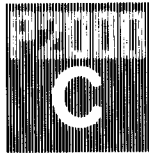

	DATA BUFFER	3.3	7-1
1	GENERAL		7-1
1.1	Temporary Storage		7-1
2	BLOCK DIAGRAM		7-1
3	CIRCUIT DESCRIPTION		7-2
3.1	Read		7-2
	3.1.1 Z80 Latch Signal For RAM Bank0 (Z80L(B0))		7-2
	3.1.2 Z80 Latch Signal For RAM Bank1 (Z80L(B1))		7-2
3.2	Write		7-3
	SHIFT REGISTER	3.3	8-1
1	GENERAL		8-1
2	BLOCK DIAGRAM		8-1
3	CIRCUIT DESCRIPTION		8-2
3.1	Alphanumeric Mode		8-2
3.2	Graphics Mode		8-2
3.3	Mode Switching		8-2
3.4	Beeper		8-3
3.5	Attribute Mixing		8-3
	ATTRIBUTE MIXING	3.3	9-1
1	GENERAL		9-1
2	BLOCK DIAGRAM		9-1
3	CIRCUIT DESCRIPTION		9-2
3.1	Underline		9-3
3.2	Blink		9-3
3.3	Invert		9-3
3.4	Beep		9-3
3.5	Video Signals		9-4
	CHARACTER GENERATOR ROM	3.3	10-1
1	GENERAL		10-1
2	BLOCK DIAGRAM		10-1
3	ADDRESSING		10-1
3.1	Character Representation in ROM		10-2
	CTC	3.3	11-1
1	GENERAL		11-1
2	BLOCK DIAGRAM		11-1
3	CIRCUIT DESCRIPTION		11-2
	V24/INTERNAL INTERFACE	3.3	12-1
1	GENERAL		12-1
2	BLOCK DIAGRAM		12-1
3	CONNECTIONS		12-2
3.1	Internal Link Connector		12-2
3.2	V24 (Optional) Connector		12-2
3.3	Jumpers		12-2

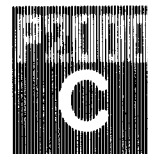

	ADDRESS DECODER	3.3	13-1
1	GENERAL		13-1
2	BLOCK DIAGRAM		13-1
3	CIRCUIT DESCRIPTION		13-2
3.1	Address Lines A14 - A15		13-2
3.2	Address Lines A6 - A7		13-2
3.3	Address Lines A0 - A1		13-2
	KEYBOARD LOGIC	3.3	14-1
1	GENERAL		14-1
2	BLOCK DIAGRAM		14-1
3	CIRCUIT DESCRIPTION		14-2
	I/O PORTS	3.3	15-1
1	GENERAL		15-1
2	BLOCK DIAGRAM		15-1
3	I/O PORTS		15-2

CHAPTER 4 - KEYBOARD

1	GENERAL	3.4	1-1
1.1	National Versions		1-1
2	CIRCUIT DESCRIPTION		1-2
2.1	Pinning		1-2
3	NATIONAL VERSION KEYBOARDS		1-3
3.1	National Version Keyboard - Austrian/German		1-3
3.2	National Version Keyboard - United Kingdom		1-3

CHAPTER 5 - MONITOR

1	GENERAL	3.5	1-1
2	SAFETY PRECAUTIONS		1-1
3	ADJUSTMENTS		1-2
3.1	Horizontal Frequency		1-2
3.2	Vertical Frequency		1-2
3.3	Horizontal Width		1-3
3.4	Vertical Height/Vertical Linearity		1-3
3.5	Picture Centering		1-3
3.6	Focus		1-3



CHAPTER 6 - DISK DRIVES

1	GENERAL	3.6	1-1
2	OPERATIONAL CHARACTERISTICS		1-2
2.1	Data Capacity		1-2
2.2	Disk Rotation Mechanism		1-2
2.3	Index		1-3
2.4	Track Construction		1-3
2.5	Magnetic Head		1-3
2.6	Track Seek Mechanism		1-4
2.7	Head Load Mechanism		1-4

CHAPTER 7 - MEMORY EXTENSION P2092

1	GENERAL	3.7	1-1
2	CIRCUIT DESCRIPTION		1-1
2.1	Extension Memory Arrangement		1-5
2.2	Standard Bank Switching		1-5
2.3	Cache Memory		1-5

CHAPTER 8 - IEEE EXTENSION P2091

1	GENERAL	3.8	1-1
1.1	IEEE Bus Signals		1-2
2	BLOCK DIAGRAM		1-3
3	SPECIFICATION		1-4
3.1	Port Address		1-4
3.2	IEEE Interrupt		1-4
3.3	Connection to Mainboard		1-5
3.4	IEEE Bus		1-5
3.5	External Connections		1-6
	3.5.1 Mounting		1-6
	3.5.2 Circuit Description		1-6
4	CIRCUIT DESCRIPTION		1-7
4.1	IEEE Selection		1-7
4.2	IEEE Output		1-7
4.3	IEEE Input		1-7
4.4	Line Termination		1-7
4.5	Test Points		1-7
4.6	Handshake Timing		1-8

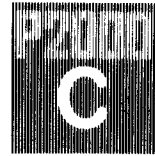

PART 4
SERVICING AND SPARE PARTS

CHAPTER 1 - REMOVAL AND REPLACEMENT OF ASSEMBLIES AND UNITS

1	GENERAL	4.1	1-1
2	THE COVER		1-1
3	MAINBOARD AND TERMINALBOARD		1-2
3.1	Terminalboard		1-2
3.2	Mainboard		1-3
4	FLEXIBLE DISK DRIVES		1-3
4.1	Jumpers and Pull Up Resistors		1-3
5	MONITOR		1-4
6	FRONT MASK		1-5
7	POWER SUPPLY UNIT		1-5
7.1	Fuse Replacement		1-5
8	MAINS SWITCH		1-6
9	MAINS SOCKET		1-6
10	DISTRIBUTION PANEL		1-6
11	KEYBOARD CABLE ASSEMBLY (INTERNAL)		1-6
12	TILT BAR		1-7
13	OPTIONAL PCB's (IEEE or RAM FLOPPY)		1-7
14	KEYBOARD		1-7

COMPONENT LOCATION

1	GENERAL	4.1	2-1
1.1	Mainboard (2-3 to 2-8)		2-1
1.2	Terminalboard (2-9 to 2-15)		2-1

CHAPTER 2 - SPARE PART CATALOGUE

1	GENERAL	4.2	1-1
1.1	Order Form (for Document Updates)		1-2
	MAINBOARD	4.2	2-1
	TERMINAL BOARD		3-1
	KEYBOARD		4-1
	IEEE BOARD		5-1
	4 x 64K RAM-BOARD		6-1
	MISCELLANEOUS PARTS		7-1

APPENDIX

A	Character Generator Listing	A-1
B	Basic Program Using Polar Co-ordinates	B-1
C	Maintenance Facilities	C-1
	(Full Contents Given At Front Of Appendix)	



LIST OF ILLUSTRATIONS

FIGURE		page
Part 1		
1.1	The P2000C Portable Computer	1.1 1-2
Part 2		
1.1	P2000C Rear Panel	2.2 1-1
2.1	Z80A CPU - Block Diagram	3.2 2-1
2.2	P2000C - CPU Block Diagram	2-2
2.3	8257 DMA - Block Diagram	3-1
2.4	P2000C - DMA Block Diagram	3-2
2.5	Circuit Diagram - DMA	3-5
2.6	P2000C - DATA/ADDRESS Buffers Block Diagram	4-1
2.7	P2000C - Clock Generator Block Diagram	5-1
2.8	Clock Generator - Detailed Block Diagram	5-2
2.9	P2000C Clock Generator - Timing Diagrams	5-3
2.10	Circuit Diagram - Clock Generator	5-5
2.11	P2000C - I/O Decoder Block Diagram	6-1
2.12	Circuit Diagram - I/O Decoder	6-2
2.13	P2000C - Memory Manager Block Diagram	7-1
2.14	Circuit Diagram - Memory Manager	7-5
2.15	HM 4864 - Block Diagram	8-1
2.16	P2000C - Random Access Memory Block Diagram	8-2
2.16a	Circuit Diagram - Random Access Memory	8-4
2.17	IPL ROM - Block Diagram	9-1
2.18	P2000C - SASI Block Diagram	10-1
2.19	P2000C - SASI Line Terminators	10-3
2.20	Circuit Diagram - SASI	10-4
2.21	uPD 765 - Block Diagram	11-1
2.22	P2000C - FDC Block Diagram	11-2
2.23	FDC Timing Diagrams	11-6
2.24	Circuit Diagram - Flexible Disk Controller	11-7
2.25	Z80A CTC - Block Diagram	12-1
2.26	P2000C - CTC Block Diagram	12-2
2.27	CTC Programming	12-5
2.28	Circuit Diagram - CTC	12-6
2.29	SIO Programming - Read Registers	13-2
2.30	SIO Programming - Write Registers	13-3
2.31	8251A USART - Block Diagram	13-5
2.32	P2000C - Serial Interfaces Block Diagram	13-6
2.33	Serial Interface Jumpers	13-13

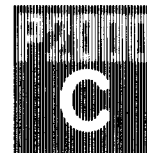

3.1	P2000C - CPU Block Diagram	3.3	2-1
3.2	CRTC MC 6845 - Block Diagram		3-1
3.3	P2000C - CRTC Block Diagram		3-2
3.4	Circuit Diagram - CRT Controller		3-4
3.5	P2000C - Timing Block Diagram		4-2
3.6	Circuit Diagram - Timing		4-4
3.7	P2000C - RAM Banks Block Diagram		5-2
3.8	Circuit Diagram - RAM Banks		5-5
3.9	P2000C - Address Multiplexer Block Diagram		6-1
3.10	Circuit Diagram - Address Multiplexer		6-3
3.11	P2000C - Data Buffers Block Diagram		7-1
3.12	Circuit Diagram - Data Buffer		7-3
3.13	P2000C - Shift Register Block Diagram		8-1
3.14	Circuit Diagram - Shift Register		8-4
3.15	P2000C - Attribute Mixing		9-1
3.16	Circuit Diagram - Attribute Mixing		9-4
3.17	P2000C - Character Generator ROM Block Diagram		10-1
3.18	Character Representation in ROM		10-2
3.19	P2000C - CTC Block Diagram		11-1
3.20	Circuit Diagram - CTC		11-3
3.21	P2000C - V24/Internal Interface Block Diagram		12-1
3.22	Circuit Diagram - V24/Internal Interface		12-3
3.23	P2000C - Address Decoder Block Diagram		13-1
3.24	Circuit Diagram - Address Decoder		13-3
3.25	P2000C Keyboard Logic - Block Diagram		14-1
3.26	Circuit Diagram - Keyboard Logic		14-3
3.27	P2000C - I/O Ports Block Diagram		15-1
7.1	Basic Memory Configuration	3.7	1-1
7.2	Layout of the 16 Accessible Segments		1-2
7.3	5½ Additional Banks - MP/M Switching		1-2
7.4	5½ Additional Banks - OASIS Switching		1-3
7.5	4 Additional Banks - CROMIX Switching		1-3
7.6	All Banks Affected by WRITE ALL		1-4
7.7	Memory Allocation Cache Mode (RAM Floppy)		1-4
8.1	Typical Instrumentation System Using IEEE Block Diagram	3.8	1-3
8.2	IEEE Extension - Handshake Timing		1-8
Part 4			
	P2000C - Part Replacement - Views 1 to 13	4.1	1-9
	Component Location - Mainboard		2-3
	Component Location - Terminalboard		2-9

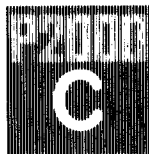

LIST OF TABLES

TABLE		page
Part 2		
1.1	Conditions for Storage and Operation of Units	2.2 1-7
Part 3		
2.1	SASI Connection (PSA)	3.2 1-2
2.2	5¼" FDC Connection (PFD)	1-2
2.3	External Terminal Connections (PSE 1)	1-2
2.4	Communications Connections (PSE 2)	1-3
2.5	Printer Connections (PSE 3)	1-3
2.6	Internal Serial Interface Connections (PSE 0)	1-3
2.7	RESET Connections (PR)	1-3
2.8	Power Supply Connections (P1)	1-3
2.9	Optional Sound Source Connection (PC)	1-3
2.10	P2000C Mainboard - Chip Select Signals	1-4
2.11	P2000C Mainboard - Control Bus Signals	1-5
2.12	Distribution of the DMA Channels	3-3
2.13	I/O Decoding	6-3
2.14	Memory Manager Decoding (I)	7-3
2.15	Memory Manager Decoding (II)	7-4
2.16	Serial Interface Jumpers	13-12
2.17	Bus Extension	14-1



THIS PAGE INTENTIONALLY BLANK



Introduction

1

INTRODUCTION

With the introduction of the Philips P2000C, it is now possible to have a complete computer system in one easily portable package; including a keyboard, a monitor and two floppy disk drives.

This 8 bit, 64 kbyte personal computer has the following features:

- compact design
- portable
- dual processor 8 bit, 64 kbytes CPU RAM
32 kbytes VID RAM
- built-in 9" monochrome green CRT
- 320 or 1280 kbytes mass storage (2 built-in floppy disks)
- choice of operating systems
 - CP/M
 - p-System (Pascal)
- optional RAM-Board (256 kbytes)
- optional IEEE board

Combining portability with the latest in computer design techniques the P2000C allows the user to make a choice of operating language and to select, from the complete internal character set, a sub-set that suits his particular needs at any moment. This character set can easily be changed at any time.

Built up on two printed circuits, one being the 'computer' the other the 'terminal' and integrated with the built-in monitor and disk drives, the P2000C comes as a complete system but allows additional units to be connected. Peripheral devices that may be added include:

- printer
- external monitor
- V24 communication device (modem)
- external 5¼" floppy disk drives
- hard disk or 8" floppy disk via SASI

The Mainboard 'computer' of the P2000C can be used in conjunction with an external terminal and the 'Terminalboard' can be used as an Intelligent Terminal.

Introduction

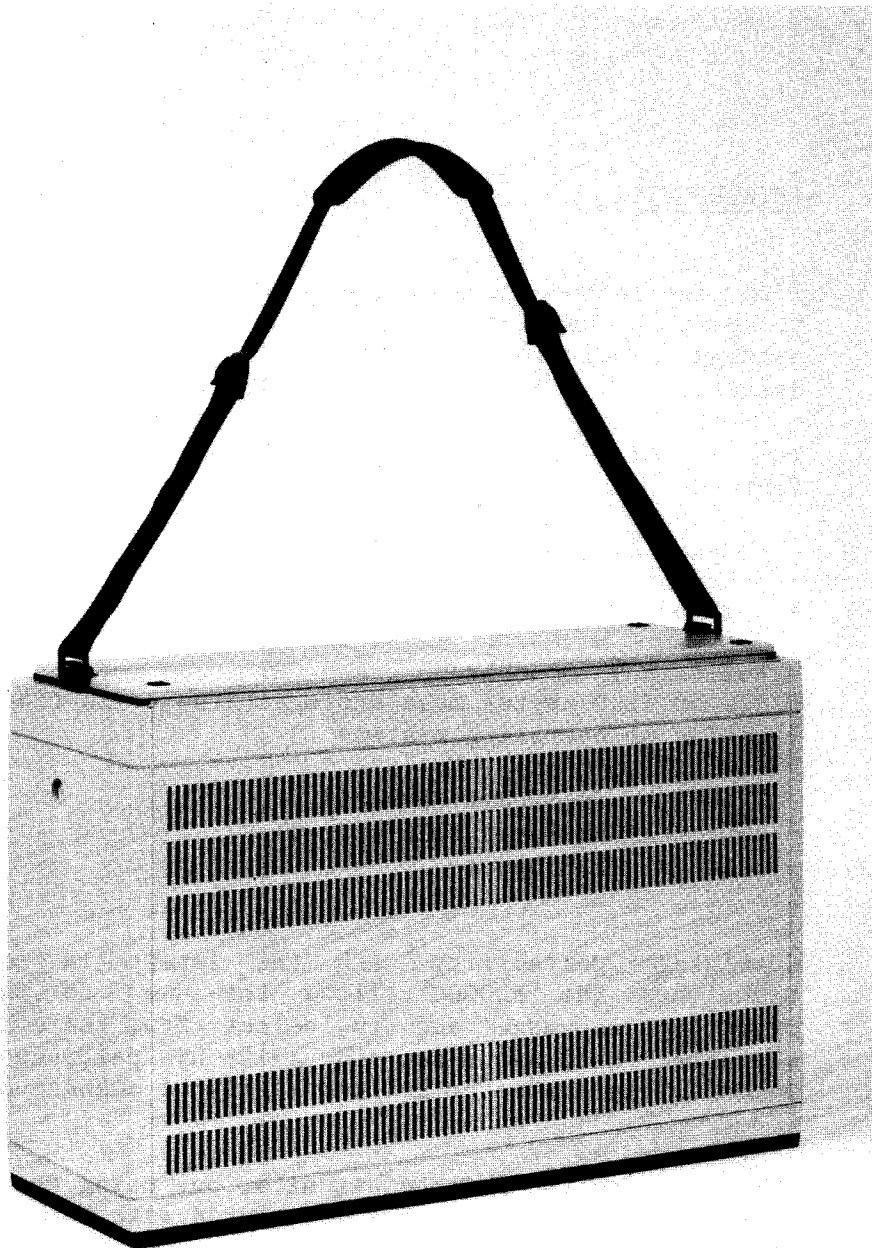

Figure 1.1 The P2000C Portable Computer



2

RELATED DOCUMENTS

CP/M Users Guide
CP/M Reference Manual

IEC Publication 435, Draft 1983
ÖVE-EM 42 Parts 1 and 2

Z80A Data Sheets: Mostek 1979 Microcomputer Components
Data Sheets

Intel Component Data Catalogue 1981
ANSI Document X3T9.3 No.185 - Shugart Associates System
Interface (SASI)

NEC uPd Floppy Disk Controller Data Sheet

TEAC FD 55 A Floppy Disk Drive Specification
Doc. No. P/N 10530146-00 B

TEAC FD 55 F Floppy Disk Drive Specification
Doc. No. P/N 10530146-03 A

Mitsubishi 9" Monitor NT-1002XU Specification

Introduction



THIS PAGE INTENTIONALLY BLANK

Operating Systems
CP/M

1

GENERAL

No attempt will be made in this manual to describe the standard CP/M operating system, as this subject is suitably covered in existing documents. The following documents are recommended:

- CP/M USERS GUIDE (supplied with the P2000C)
- CP/M REFERENCE MANUAL

Operating Systems
CP/M

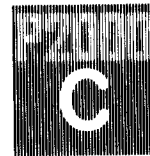

THIS PAGE INTENTIONALLY BLANK

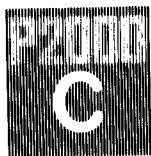

Operating Systems
p-System

1

GENERAL

No attempt will be made in this manual to describe the standard p-System operation, as this subject is suitably covered in the relevant documentation.

Operating Systems
p-System

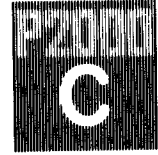

THIS PAGE INTENTIONALLY BLANK



Operating Systems
Basic I/O System (BIOS)

1 GENERAL

The two Operating Systems currently available are:

- CP/M[#] 2.2;
- p-Systems^{*} 4.1-2

and are used with the Basic Input Output System (BIOS).

The 4 KBytes System PROM (I P L PROM) contains:

- the initial loading program
- the drivers for the peripheral devices
- a memory and peripheral debugger for maintenance purposes

2 INITIAL PROGRAM LOAD (IPL)

The sequence of events during IPL is as follows:

- Port Initialization
- Transfer part of device drivers to RAM
- Initial handshake with the terminal board
- Initialization of floppy controller
- Load system track(s) from floppy or hard disk

These events are described below.

2.1 Port Initialization

The ports are initialized as follows:

- Reset for SASI controller.
- CTC1 channel-0 supplies 19200 x 16 Hz for SIO-B (terminal).
channel-1 supplies 9600 x 32 Hz for SIO-A (comms).
channel-2 supplies 1200 x 16 Hz for USART (printer).
channel-3 is programmed as DMA interrupt device.

* Trademark of Softech Microsystems

Trademark of Digital Research Inc.

Operating Systems
Basic I/O System (BIOS)

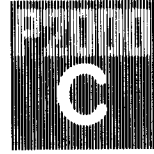

- CTC2 channel-0 generates the 60 Hz timer interrupts.
channel-1 generates 2400 Hz for channel-0.
channel-2 is not initialized (reserved for extensions).
channel-3 is the interrupt device for floppy and SASI.
- SIO channel-A is a polled asynchronous communication device.
channel-B is programmed for DMA output and interrupt
driven input for the terminal interface.
- USART is programmed as an 1200 Baud output device for the
printer.
- Floppy controller is reset.

2.2 Transfer (part of) Device Drivers to RAM

The following blocks are transferred:

- Jump table for the console status, console input, console
output, list output, communication output and communication
input subroutines to address F606. This table is followed by
the memory disk initialization program.
- The RAM resident part of the device driver subroutines and
the corresponding tables that have to be initialized.
- Table of interrupt vectors to address FFD0.

2.3 Initial Handshake with the Terminal Board

Two characters are expected from the terminal board and they
are immediately returned. No further operation takes place
until this handshake is completed. If this handshake is not
completed successfully, the message 'SYSTEM ERROR' is displayed
by the terminal program.

2.4 Compute ROM Checksum

All bytes in the ROM from 0 to FFD are added in a two byte long
word and compared with the value stored in FFE and FFF. If no
match is found, the message BAD ROM is displayed and the
program stops, otherwise the IPL version number is displayed.
(e.g., 'IPL-1.1').



Operating Systems
Basic I/O System (BIOS)

2.5 Initialize the Floppy Controller

If the ready bit of the floppy controller is not set the system ignores all further floppy commands (the SASI interface remains active).

If the ready bit of the floppy controller is set, a wait loop is started until the first interrupt from the floppy controller is sensed. A SPECIFY command is then issued with the following values:

- Step rate time = 6 ms
- Head unload time = 480 ms
- Head load time = 5 ms

2.6 Load System Track(s) from Floppy or Hard Disk

An attempt is made to read side-0 track-0 from floppy-1 to D600. If no valid data is obtained, HARD DISK-1 and then floppy-2 are read. If unsuccessful, the message "SYSTEM DISK?" is displayed and the user can depress any key (except ESC) to repeat the procedure.

When the first track (side-0 track-0) has been loaded, the following data structure is expected:

- Bytes 0, 1, 2: C3 xx xx Jump to continue program
- Byte 3: 80H Load only one track
- 81H Load the second track from side-0 track-1
- 82H Load the second track from side-1 track-0
- Byte 4: PB Printer baud rate byte
- Byte 5: CB Communication baud rate byte
- Byte 6: SR Floppy step rate byte
- OD0 For 6ms (system with 160K drives or mixed drives)
- OE0 For 4ms (system with 640K drives only)

If byte-3 is not in the range 80 - 82H, the track is considered as invalid.

If a valid IPL track-0 is read, and Byte-3 is 81 or 82H, then the second track is read to E600.

The baud rate bytes (4 and 5) are:

Speed	75	150	300	600	1200	2400	4800	9600	19200
Byte	0	80H	40H	20H	10H	08H	04H	02H	01H

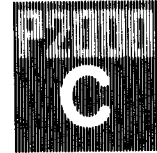

Operating Systems
Basic I/O System (BIOS)

The printer and communication speeds are then corrected according to Bytes 4 and 5, the floppy step rate is updated according to byte 6 and a jump is made to the extension RAM initialization program.

The extension RAM (which may be fitted as an option - see Chapter 7) is expected to be used as a RAM disk and therefore its directory range must be cleared after reset.

After the RAM disk initialization the 4 system clock bytes are also cleared.

If the user wants to preserve the information on the memory disk and the system clock, he must depress the SPACE bar during RESET and hold it down for at least 5 seconds.

Note: Generally, information on the memory disk will not be changed but it is stressed that this cannot be guaranteed.

The memory manager is then switched to RAM operation, the extension RAM is switched off and the program is continued on D600 i.e., the first user supplied instruction.

The BOOTDR byte (Byte 1AH in DPB - Driver Parameter Block) contains the address of the booting device:

0: floppy-1
1: floppy-2
FF: hard disk

3

DRIVERS FOR THE PERIPHERAL DEVICES

The peripheral drivers are located partly in the System ROM, partly in the highest part of the RAM. The entry points are always in RAM and can be accessed either from the loaded jumping table or from the Driver Parameter Block. The address of the Driver Parameter Block is stored at FFDOH.

EXAMPLE

To use the disk-read routine:

```

READ:LD  HL,(OFFDOH)  ;addr of parameters block
      LD  DE,9        ;offset in the DPB
      ADD HL,DE
      LD  E,(HL)
      INC HL
      LD  H,(HL)
      LD  L,E         ;HL has the ADDRESS OF RDS
      JP  (HL)       ;jump to read subroutine

```

This sequence can be used, of course, only as CALL READ.



Operating Systems
Basic I/O System (BIOS)

3.1 Driver Jumping Table

The jumping table loaded by the IPL starts at address F606. It can be overwritten by the loaded operating system after the required addresses are patched into the CBIOS or SBIOS.

The first jump instruction in this table is directed to the Console Status subroutine. The address of this sub-routine is also the first address used by the system.

The table contains the following items:

3.1.1 CONSOLE STATUS

F606: JMP CONST

Action: the value of KSTAT (byte 27H in DPB) is read.
On exit: A = FF and zero flag is reset if any key input
A = 0 and zero flag is set if no key input
all other registers are unchanged.

3.1.2 CONSOLE INPUT

F609: JMP CONIN

Action: wait until KSTAT is non-zero
clear KSTAT
enable next keyboard interrupt
if SIO contains no further characters, set the DTR line
get KBYTE (byte 28H in DPB) into the accumulator. (In the keyboard interrupt subroutine the KSTAT byte is set to FF and the DTR line on the SIO is reset.)
On exit: A = input character
registers H and L are lost, all other registers are unchanged.

For details of the caps lock function see the description of the terminal board software.

Operating Systems
Basic I/O System (BIOS)

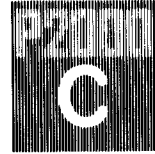

3.1.3 CONSOLE OUTPUT

F60C: JMP CONOUT

On entry: register C contains the character to be output.

Action: wait until a place is free in the 40H bytes long TTOBUF field and put the character on the first free buffer position; if it is the first position in the buffer, start DMA transfer.

Note: (If a DMA transfer is ready, a DMA interrupt is generated. The interrupt service routine checks if any characters are waiting in the buffer for sending. If so, these characters are shifted to the start of the buffer and the next DMA transfer is started. The buffer pointer is set to the first free position. As a result, other operations can be done by the system during terminal transfer because it does not have to wait for transmission ready.)

On exit: All registers except A are unchanged.

3.1.4 LIST (PRINTER) OUTPUT:

F60F: JMP LIST1

On entry: register C contains the character to be printed.

Action: the PRTAB word (Bytes 15H & 16H in DPB) is checked.

If zero - the character is printed without change.

If nonzero - it is the address of the printer table.

(Its structure is described in the CP/M Reference Manual in the section dealing with the Configuration Program). If the character is found in the table, it is replaced by the table value(s), otherwise it is printed without change. If a character is not found in the printer table and its' value is over 9FH, a space (20H) is printed. This saves some bytes in the printer table.



Operating Systems
Basic I/O System (BIOS)

If both the printer and the USART are ready, the character is printed immediately, otherwise the PRSTAT byte (Byte 18H in DPB) is checked.

If zero - an error return is made immediately.

If nonzero - the PRWAIT byte (Byte 17H in DPB) is checked. It defines the maximum waiting time in 4 second units, however a value of 4 can mean a waiting time between 12 and 16 seconds. During the wait loop, repeated attempts are made to print. In the event of a timeout the PRCONT byte (Byte 19H in DPB) is checked.

If zero - an error return is made.

If nonzero - the message 'IGNORE PRINTER WITH ESC' is displayed and the next console input is checked. If 'ESC' an error return is made, otherwise the checking of the ready bit is repeated.

On exit: if print was successful, register A and PRSTAT = FF and zero flag reset.
if printer error, register A and PRSTAT are 0 and zero flag is set.
Registers B,C,D,E,H and L are lost.

3.1.5 COMMUNICATION (PUNCH) OUTPUT

F612: CALL COMOJP

On entry: register C contains the character to be sent.

Action: waits until the SIO-A transmitter is ready and then sends the character.

On exit: registers A, H and L are lost.

3.1.6 COMMUNICATION (PUNCH) INPUT:

F615: CALL COMIJP

Action: wait until the SIO-A receiver is ready and then fetch the character.

On exit: register A holds the received character.
registers H and L are lost.

Operating Systems
Basic I/O System (BIOS)

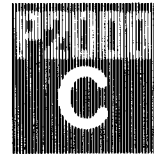

3.2 Routines Defined by the Driver Parameter Block (DPB)

The address of the Driver Parameter Block is stored at FFDO-FFD1. (It is the first address in the interrupt vector table, but the corresponding channel never interrupts). The subroutine addresses defined in this block must be patched into the operating system after program load.

3.2.1 READ ONE OR MORE SECTORS FROM DISK

Bytes 09-0AH: DEFW RDS

On entry: Bytes 0 - 8 of the DPB must be correct.

Byte 0: DRIVE - defines the selected drive.

Values: 00H floppy-1
01H floppy-2
02H floppy-3
03H floppy-4
10H memory disk
FFH hard disk-1
FEH hard disk-2

Bytes 1 & 2: TRACK - defines the selected track, low byte on 1, high byte on 2. The ranges:

0 to 27H (39) for single track
0 to 4FH (79) for double track
0 to 3FH (63) for memory disk
0 to 4C7H (1223) for 5 MB hard disk
A track length of 4 kbytes is assumed.

Byte 3: SECTOR - defines the selected sector

Range: 1 - 10H

Byte 4: HEAD - defines which side of floppy is taken

0 for side - 0
1 for side - 1

Byte 5 & 6: RWBUFF - defines the address of read or write data

Byte 7 & 8: RWLGTH - is transfer length-1 (FFH for 1 sect, OFFFH for 1 track). For floppy and memory disk transfer the operation must not extend over the track limit. For hard disk the maximum value is 3FFFH.

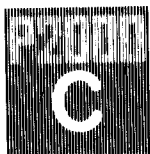

Operating Systems
Basic I/O System (BIOS)

Action - Floppy Calls:

If the NOFLOP flag is set (floppy controller not ready after initialization), an error return is made. If the floppy controller is present, the motor is switched on if not already running. A seek is made to the required track if different to the previous access. The floppy controller parameter block is filled in. A call is made to DSKTR (DPB + 1FH). If this location has 0 (NOP), standard numbering is expected, if 24H (INC H), an old PHILIPS format is selected (track-0 is numbered with 1). The controller is then activated.

The transfer is carried out under DMA control. If an error has been found, the procedure is attempted 8 times, the head is stepped out 10 tracks if TRACK is less than 10, the controller is recalibrated, a seek is made to the track and 8 new attempts are made. If not successful, an error return is made. No repeat is made if 'disk not ready' is found or if the disk is write protected.

Action - Hard Disk Calls:

The XEBEC parameter block is filled in. The SASI controller ready bit is checked and, if not ready, an error return is made.

The DMA is programmed for transfer, and the XEBEC parameter block is transmitted. If an error is found, the hard disk error subroutine (HDETSU from DPB bytes 1D-1EH) is called (it is an empty program, for maintenance purposes only), the controller is reset and the procedure is repeated.

After a floppy or hard disk operation the DMA is checked for transfer length to avoid incorrect transfers. In case of error the operation is repeated according to the repetition algorithm.

Action - Memory Disk Calls:

IMPORTANT WARNING: RWBUFF MUST ALWAYS HAVE AN ADDRESS OVER 8000H!!!

The selected track number and the existence of the extended memory is checked. If OK, the corresponding cache block is switched and the transfer is made.

On exit: A = 0 and zero flag is set if operation OK, otherwise A = FF and zero flag is reset.

Registers HL DE and BC are destroyed.

The DPB bytes 0 to 8 are not changed! In case of floppy calls the RESULT field (DPB bytes 2D to 33H) contains the controller result bytes.

Operating Systems
Basic I/O System (BIOS)

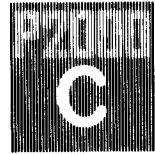

3.2.2 WRITE ONE OR MORE SECTORS TO DISK

Bytes OB-OCH: DEFW WRS

All interfaces are identical to the READ subroutine.

3.2.3 STEP TO A TRACK (floppy only)

Bytes OD-OEH: DEFW STEP

The given address is the System ROM address of the stepping routine, therefore the System ROM must be switched on before calling. Its use is not recommended except for maintenance purposes.

On entry: DRIVE and TRACK in DPB must be filled.

Action: if the selected drive and track are identical with the previous ones, nothing is done. If the present track position is undefined, a RECALIBRATE precedes the SEEK operation.

On exit: all simple registers are destroyed.

3.2.4 RECALIBRATE DRIVE (floppy only)

Bytes OF-10H: DEFW RECAL

The given address is the system ROM address of the recalibrate routine, therefore the system ROM must be switched on before calling. Its use is not recommended except for maintenance purposes.

On entry: DRIVE in DPB must be filled.

Action: the selected drive is recalibrated (stepped to track-0).

On exit: all simple registers are destroyed.

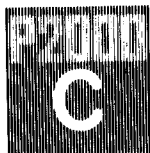

Operating Systems
Basic I/O System (BIOS)

3.2.5 BOOT THE SYSTEM TRACK(S) FROM THE SELECTED DRIVE

Bytes 11-12H: DEFW BOOTER

On entry: DRIVE contains the selected drive

Action: the track-0 of the selected drive is read to D600H.
In case of error the "SYSTEM DISK?" message is displayed and the operator must depress any key except ESC to repeat.

If D603 = 80 a return is made

81 track-1 is read from the same side to E600H

82 track-0 is read from the other floppy side to E600H.

On exit: RWBUFF, RWLGT and all simple registers are destroyed.

3.2.6 GET LISTING DEVICE STATUS

Bytes 13-14H: DEFW LISTAT

Action: the USART control byte is read. DSR, TxRDY and TXEMPTY must be set for ready. (The printer READY BIT is connected to the USART DSR pin because it can be read directly from control byte.)

On exit: if device ready, A = FFH and zero flag is reset.
If device busy, A = 0 and zero flag is set.
All other registers are unchanged.

3.2.7 PRINT SCREEN

Bytes 21-22H: DEFW PRSCR

PRSCR is an auxiliary subroutine to print one or more lines from the screen.

On entry: BC = the screen address (top-left position is 0)
A = the number of lines to print (1 to 24)

On exit: A = FF and the zero flag is reset if printing successful
A = 0 and the zero flag is set if either:
- the range specified is out of the screen range
- a printer error has occurred

WARNING No key may be depressed during the print procedure.

2.1

3-12

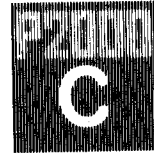

Operating Systems
Basic I/O System (BIOS)

3.3

System Timer

The system supports a 4 bytes long 60 Hz system timer. Its value can be accessed in DPB Bytes 29 to 2CH (29H is the lowest byte). This CLOCK field is cleared on reset unless the user depresses the SPACE bar.

The user can also define a subroutine that will be called in every 16.7 ms. Its address is stored at DPB bytes 25-26H. The user must save all registers and as no CP/M stack may be used a user defined stack must be set up.

3.4

Summary of the Driver Parameter Block

The pointer to this block is stored at FFD0H.

00 DRIVE	ACTUAL DRIVE NUMBER
01 TRACK	ACTUAL TRACK NUMBER
03 SECTOR	ACTUAL SECTOR NUMBER
04 HEAD	ACTUAL HEAD NUMBER
05 RWBUFF	READ-WRITE BUFFER ADDR
07 RWLGT	READ-WRITE LENGTH - 1
09 RDS	READ SECT SUBROUTINE ADDR
0B WRS	WRITE SECT SUBROUTINE ADDR
0D STEP	SEEK SUBROUTINE ADDR IN PROM
0F RECAL	RECALIBRATE SUBROUTINE ADDR IN PROM
11 BOOTER	BOOTER SUBROUTINE ADDR
13 LISTAT	LIST STATUS SUBROUTINE ADDR
15 PRTAB	PRINT TABLE ADDR
17 PRWAIT	MAX PRINTER WAITING TIME IN 4 SEC UNITS
18 PRSTAT	PRINTER STATUS BYTE IS 0 IF PR ERR OCCURED
19 PRCONT	IF 0, NO MESSAGE IF PRINTER NOT RDY
1A BOOTDR	BOOTING DRIVE (0, FF OR 1)
1B DSKFLG	INTERNAL DISK FLAG
1C DMSTAT	DMA SHADOW BYTE
1D HDERSU	XEBEC ERROR ROUTINE ADDR FOR MAINTENANCE
1F DSKTR	00, C9 FOR STANDARD TRACK NUMBERING 24, C9 FOR OLD PHILIPS TRACK NUMBERING
21 PRSCR	PRINT SCREEN SUBROUTINE ADDR
23 MSWBYT	0 IF ROM, 2 IF RAM PROGR RUNS
24	C3 FOR JUMP
25 TINEX	ADDRESS OF EXTERNAL TIMER INT
27 KSTAT	KEY STATUS IS 0 IF NO KEY DEPRESSED
28 KBYTE	HOLDS THE LAST DEPRESSED KEY
29 CLOCK	4 BYTES LONG 60 HZ CLOCK
2D RESULT	7 BYTES LONG FIELD FOR FLOPPY RESULT BYTES

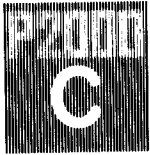

Operating Systems
Basic I/O System (BIOS)

3.5 Interrupt Vector Table

The interrupt vector table has a fixed location: FFD0H.
The CPU I register is always FF and it should not be changed!

CTC1 INTERRUPTS

FFD0	DEFW DRIVE	ADDRESS OF DRIVER PARAMETER BLOCK
FFD2	DEFW RETIN	
FFD4	DEFW RETIN	
FFD6	DEFW INTDMA	DMA INTERRUPT SUBROUTINE

CTC2 INTERRUPTS

FFD8	DEFW TIMER	TIMER INTERRUPT
FFDA	DEFW RETIN	
FFDC	DEFW RETIN	RESERVED FOR EXTENSIONS OR THE USER
FFDE	DEFW FDCINT	FLOPPY OR SASI INTERRUPT

SIO INTERRUPTS

FFE0	DEFW RETIN	
FFE2	DEFW RETIN	
FFE4	DEFW CONINT	CONSOLE INTERRUPT
FFE6	DEFW CERINT	CONSOLE ERROR INTERRUPT (OVERRUN)
FFE8	DEFW RETIN	
FFEA	DEFW RETIN	
FFEC	DEFW RETIN	
FFEE	DEFW RETIN	

The range FFF0 to FFFF is reserved for interrupts generated by any extension unit.

The address of any interrupt subroutine must be over 1000H.

If an extension card (e.g., IEC card) is implemented using the FFDC interrupt location, the user must not use it again.

Operating Systems
Basic I/O System (BIOS)

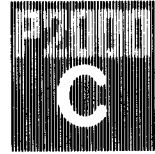

4

CP/M INITIALIZATION

After a successful IPL procedure, control is transferred to the CP/M initialisation program. It is stored partly in the first 128 bytes of the IPL track, partly in the DIRBUF area that will be deleted later. A free space of about 30 bytes is reserved on the first IPL sector where the user can patch some special initializations; it is filled with HEX-0.

The CP/M initialization program has the following functions:

- modifies internal driver table and start up message if IPL has been done from floppy-2,
- fetches the addresses of CONST, CONIN, CONOUT, LIST1, PRSCR, COMOJP and COMIJP from the driver jumping table and patches them into the CBIOS
- fetches the addresses of subroutines from the driver parameter block and patches them into the CBIOS
- loads the keyboard table to the terminalboard
- loads the screen table to the terminalboard
- sends the CAPS LOCK properties to the terminalboard:
 - caps lock character is 80H
 - caps lock limit in ASCII table as configuredCAPS LOCK is activated on startup if so configured.
- prints the startup message (PHILIPS P2000C ..K CP/M 2.2)

CP/M is shifted to the proper position, the CP/M jumps on the 0-page are set, and a jump is made to CP/M.

If a BASIC environment has been configured, no CP/M message is displayed, but the program BASIC.COM is loaded and started. The specified AUTOLOAD command is brought to the 80H...FFH range.

In the BASIC environment the CP/M cannot be used.

There is a special key in the CP/M implementation with the symbol \mathcal{S} . In the standard configuration its value is 80H and has a CAPS LOCK toggle function. If it is used together with the Supershift key, its value is 90H and it activates the PRINT SCREEN function.

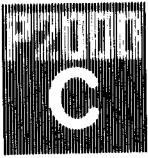

Operating Systems
Basic I/O System (BIOS)

3.5 Interrupt Vector Table

The interrupt vector table has a fixed location: FFD0H.
The CPU I register is always FF and it should not be changed!

CTC1 INTERRUPTS

FFD0	DEFW DRIVE	ADDRESS OF DRIVER PARAMETER BLOCK
FFD2	DEFW RETIN	
FFD4	DEFW RETIN	
FFD6	DEFW INTDMA	DMA INTERRUPT SUBROUTINE

CTC2 INTERRUPTS

FFD8	DEFW TIMER	TIMER INTERRUPT
FFDA	DEFW RETIN	
FFDC	DEFW RETIN	RESERVED FOR EXTENSIONS OR THE USER
FFDE	DEFW FDCINT	FLOPPY OR SASI INTERRUPT

SIO INTERRUPTS

FFE0	DEFW RETIN	
FFE2	DEFW RETIN	
FFE4	DEFW CONINT	CONSOLE INTERRUPT
FFE6	DEFW CERINT	CONSOLE ERROR INTERRUPT (OVERRUN)
FFE8	DEFW RETIN	
FFEA	DEFW RETIN	
FFEC	DEFW RETIN	
FFEE	DEFW RETIN	

The range FFF0 to FFFF is reserved for interrupts generated by any extension unit.

The address of any interrupt subroutine must be over 1000H.

If an extension card (e.g., IEC card) is implemented using the FFDC interrupt location, the user must not use it again.

Operating Systems
Basic I/O System (BIOS)

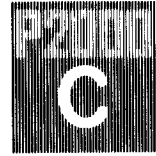

4 PERIPHERAL AND MEMORY DEBUGGER

4.1 General

If the BOOTER subroutine can not boot and the "SYSTEM DISK?" message is displayed, the user can type the ESC key to enter the debugger.

The primary aim of this module is to help troubleshooting. Even if booting is impossible it enables the user to make a short check for memory, ports, floppy disk, hard disk, video, keyboard and printer.

4.2 Commands

The debug program starts with the following prompt:

```
'Commands: C, D, DR, DW, F, G, M, P, PS, S, SK  
Entry:   Command Start_address,End_address,Other_info'
```

The command code may be followed by a space (not necessary). The separator between the operands may be a space or a comma. The syntax is similar to that of the DDT of Digital Research. An automatic caps lock function is implemented, i.e., lower case letters can not be entered.

To exit the debugger type 'GO (CR)' and any two characters (initial terminal handshake) or simply depress the reset button.

This section gives the commands that are implemented.

4.2.1 COMPARE MEMORY BLOCKS

Example: C 4000 4FFF 5000

This command compares the block 4000 to 4FFF with 5000 to 5FFF and the differences are displayed.



Operating Systems
Basic I/O System (BIOS)

4.2.2 DISPLAY MEMORY BLOCK

Example: D 6000 607F

The contents of the range 6000 to 607F is displayed (hex and ASCII). As the program stores the last displayed address and the length of block, the user has only to enter D and RETURN to see the next block (6080 to 60FF). The first D and RETURN entry shows the range 4000 40FF. (4000 is the first address of the default disk buffer). After a disk read or write command the actual disk buffer address overwrites this address. A long display may be stopped temporarily by the CTRL-S character. After the next CTRL-S it is continued, any other character cancels the command.

4.2.3 DISK READ TRACK

Example: DR 126 5000

Reads drive-1 track 26 (decimal) to 5000 through 5FFF.

The first digit is the drive number:

- 1: Floppy-1 first side
- 2: Floppy-2 first side
- 3: Floppy-3 first side
- 4: Floppy-4 first side
- 5: Floppy-1 second side
- 6: Floppy-2 second side
- 7: Floppy-3 second side
- 8: Floppy-4 second side
- 9: Hard disk-1

The second and third digits give the track number. For floppies it must be 0 to 79, for hard disk 0 to 99 (i.e., only a small part of the hard disk can be read this way).

If no read address is given, the default value is 4000.

The defined track is read continuously until any key is depressed and the result of each 'read' is displayed. The result will be either OK or, in the event of an error, the RESULT bytes of the uPD765 Floppy controller. (In the case of hard disk error this RESULT byte has no meaning).

Operating Systems
Basic I/O System (BIOS)

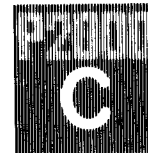

4.2.4 DISK WRITE TRACK

Example: DW 69

The data from 4000 to 4FFF is written to drive-2, second side, track-9. ALL characteristics given for the read function are valid here too.

4.2.5 FILL THE MEMORY BLOCK WITH ONE BYTE

Example: F 8233 875D 55

The range 8233 to 875D is filled with 55H.

4.2.6 GO TO AN ADDRESS (CALL A PROGRAM)

Example: G 5000

The user can enter small programs with the S(et) command and execute with G. The C9 (RET) instruction leads back to the debugger.

4.2.7 MOVE MEMORY BLOCK

Example: M 4000 4FFF 5000

The block 4000...4FFF is copied to 5000...5FFF.

4.2.8 PORT READ/WRITE

Example: P 2A

The port address 2A is read, after which the user can enter a byte that is output to the port. Afterwards port 2B can be read...and so on. If nothing has to be output, type RETURN. To cancel the command type '.' and RETURN.

The command P and RETURN displays the port map 00..FF.



Operating Systems
Basic I/O System (BIOS)

4.2.9 PRINTER SWITCH

Example: PS

After entering the PS command all information on the monitor is printed. It can be cancelled by another PS command.

4.2.10 SET MEMORY

Example: S 4000

The first address and its contents will be displayed.

```
4000 21      - original contents 21H
```

The contents can be altered [enter new value], or left unchanged [enter CARRIAGE RETURN]. The next address will then be displayed. To cancel the command, enter '.'

```
4000 21 31  - changes contents to 31H
4001 00 10  - changes contents to 10H
4002 50      - leaves contents as 50H
4003 32 3A  - changes contents to 3AH
4004 55 .    - cancels command
```

Invalid inputs (outside the range 0 - 9, A - F) will be treated as zeros.

4.2.11 SEEK STRING IN MEMORY

Example: SK CD F9 F6

All addresses where the string CD F9 F6 occurs are displayed.

Operating Systems
Basic I/O System (BIOS)

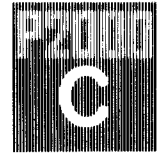

5

CP/M INITIALIZATION

After a successful IPL procedure, control is transferred to the CP/M initialisation program. It is stored partly in the first 128 bytes of the IPL track, partly in the DIRBUF area that will be deleted later. A free space of about 30 bytes is reserved on the first IPL sector where the user can patch some special initializations; it is filled with HEX-0.

The CP/M initialization program has the following functions:

- modifies internal driver table and start up message if IPL has been done from floppy-2,
- fetches the addresses of CONST, CONIN, CONOUT, LIST1, PRSCR, COMOJP and COMIJP from the driver jumping table and patches them into the CBIOS
- fetches the addresses of subroutines from the driver parameter block and patches them into the CBIOS
- loads the keyboard table to the terminalboard
- loads the screen table to the terminalboard
- sends the CAPS LOCK properties to the terminalboard:
 - caps lock character is 80H
 - caps lock limit in ASCII table as configuredCAPS LOCK is activated on startup if so configured.
- prints the startup message (PHILIPS P2000C ..K CP/M 2.2)

CP/M is shifted to the proper position, the CP/M jumps on the 0-page are set, and a jump is made to CP/M.

If a BASIC environment has been configured, no CP/M message is displayed, but the program BASIC.COM is loaded and started. The specified AUTOLOAD command is brought to the 80H...FFH range.

In the BASIC environment the CP/M cannot be used.

There is a special key in the CP/M implementation with the symbol \mathcal{S} . In the standard configuration its value is 80H and has a CAPS LOCK toggle function. If it is used together with the Supershift key, its value is 90H and it activates the PRINT SCREEN function.

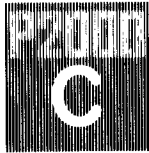

Operating Systems
Terminal Board Firmware

1 GENERAL

1.1 Memory Layout

FFFFH	-I-		
	I	←...E800H - FFFFH	Character mode attribute RAM
E000H	-I-		
	I		
D000H	-I-		
	I		
C000H	-I-	↑...C000H - FFFFH	16 kB attribute & graphic RAM
	I	←...B800H - BFFFH	2 kB Character video RAM
B000H	-I-	↓...Program stack	(starting at B800H)
	I		
A000H	-I-		
	I		
9000H	-I-		
	I	←...RAM FREE TO USE	(returned by STATUS info.)
8000H	-I-	←...Start of program RAM area	(tables & variables)
	.		
7000H	--		
	.		
6000H	--		
	.		
5000H	--	ADDRESSING SPACE FOR 2 X 16 kB ROM	
	.		
4000H	--		
	.		
3000H	--		
	.		
2000H	-I-)		
	I		
1000H	-I-)	0000H - 1FFFH	8 kB ROM (PROGRAM)
	I		
0000H	-I-		

The RAM area from RAM FREE TO USE to (B800H - STACK) may be used by the user-program (loaded in INTEL-HEX FORMAT). The area from C000H to E800H may also be used if the High Resolution Graphic mode is not used. The RAM FREE TO USE is fixed for any particular software release but may change on re-issue.

Operating Systems
Terminal Board Firmware

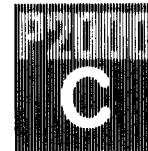

1.2 Features

1.2.1 COMMUNICATION

Asynchronous up to 19200 Bd.
(Queued in both directions in a 255 byte queue.)

1.2.2 KEYBOARD

8-bit code supporting national versions.
Standard ASCII key table in ROM, download of national versions possible.
Keys queued.

1.2.3 SCREEN

8-bit code (national versions) 24 lines/80 characters

Character Mode

- Bidirectional scrolling
- Split-screen capability (partial scroll)
- Three Attribute modes:
 - Manual Read and write data from/to attribute page (normal memory access).
 - Auto duplicate: The read attribute data will be duplicated.
 - Block mode: For "block moves" such as scrolling, the attribute page will be scrolled automatically.
- Attributes: Underline)
 Invert) and all
 Blink) combinations
 4 Intensity levels)
- Adjustable TABs
- Teletext graphics
- Text and Attributes back-transfer from screen possible.

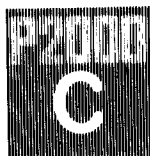

Operating Systems
Terminal Board Firmware

High Resolution Graphics Mode

- 2 selectable modes
 - 512 x 252 dots (no attributes)
 - 256 x 252 dots (3 intensity levels + background)

Each dot addressable

Simple vector handling:

- In Cartesian and Polar co-ordinates.
- Combination with character mode (characters: 21 lines/64 characters).

2 DETAILED DESCRIPTION

2.1 Communication

The communications control between the terminal and the CPU is done by the V24 control lines. Transfer rate is asynchronous at 19200 Baud.

2.1.1 Transfer - CPU to Terminal

Note: RTS of terminal is connected to CTS of CPU and CTS of terminal is connected to DTR of CPU.

The terminal sets RTS (data terminal ready) if it is ready to receive. (Normal situation)

The CPU can send data, but has to check if CTS is high during sending (this is done by hardware).

The terminal stores the characters in an internal queue and resets RTS when the queue is full or the terminal is no longer ready to receive.

2.1 2 Transfer - Terminal to CPU

This is done the same way.

Operating Systems
Terminal Board Firmware

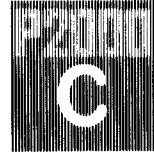

2.2 Keyboard

The pressed keys will be converted into the extended ASCII-code corresponding to the key tables and stored in a queue. If there is a character in the queue the terminal will send it to the CPU as described.

2.3 Screen and Screen Codes

The screen is controlled by both single codes and ESCape sequences.

2.3.1 SINGLE CODES

The single codes are shown in the following table:

A C T I O N	Code
Cursor Home	SOH 01H
Cursor Forward	ACK 06H
Cursor Down	LF 0AH
Cursor Up	SUB 1AH
Cursor Back	NAK 15H
Bell-Beep	BEL 07H
Backspace	BS 08H
TAB	TAB 09H
Clear Screen	FF 0CH
CR	CR 0DH
End of Page (column 80, row 24)	EOT 04H
Reset Terminal	CAN 18H
CAPS_LOCK	SI 0FH
Lock Keyboard	EM 19H
Unlock Keyboard	STX 02H

Note: The Reset Terminal command (18H) causes a software reset (re-initialize) to the terminal software. It has the following effects:

- Clears receive and transmit queues
- Resets TABS to every 8 columns
- Clears the screen
- Unlocks all locked areas

After the RESET command the terminal is unable to receive characters for about 200 msecs.

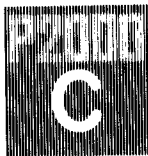

Operating Systems
Terminal Board Firmware

CONTROL CODE (CTRL) GENERATION

Any code between 00H and 1FH, received by the Terminalboard, is treated as a CONTROL character and is used to initiate special actions. These are shown, as Single Codes, in the table on the previous page. It should be noted that the mnemonics given to these codes are of a general (Data Communications) nature, and do not always reflect their use within the P2000C.

For example, the codes 01H (SOH - start of heading) and 06H (ACK - acknowledge) have no relation to the cursor movements produced by these codes in the P2000C. On the other hand the code 08H (BS - backspace) is used for that function.

To warn the Terminalboard that a CONTROL character will be sent, the CTRL key must first be pressed. This will be indicated on the Monitor with the symbol "^". The hexadecimal code of the following key will then be treated as the CONTROL character. The second character of the control code will always be taken from columns 4 and 5 of the ASCII table. See table below.

Generally, the character following the CTRL will come from the main ASCII character set, in the range 20H to 7FH. This value will be reduced by 60H, 40H or 20H; to give a value between 00H and 1FH.

As the P2000C only uses the least significant 7 bits of a generated character code, a code between A0H and FFH will be reduced by 80H, the resultant value, in the range 20H to 7FH, being treated as above.

Direct CONTROL characters can be produced by setting the Keyboard Table to produce codes in the range 00H to 1FH. In this case the CTRL key would not be used. Similarly, if a value between 80H and 9FH is produced, via the Keyboard Table, the reduction by 80H will also give direct CONTROL characters.

CTRL ACTION	CODE	CTRL ACTION	Code
^A Cursor Home	01H	^F Cursor Forward	06H
^J Cursor Down	0AH ¹⁰	^Z Cursor Up	1AH ²⁶
^U Cursor Back	15H ²¹	^G Bell-Beep	07H
^H Backspace	08H	^I TAB	09H
^L Clear Screen	0CH ¹²	^M CR	0DH ¹³
^D End of Page (col 80, row 24)	04H	^X Reset Terminal	18H ²⁴
^O CAPS-LOCK	0FH ¹⁵	^Y Lock Keyboard	19H ²⁵
^B Unlock Keyboard	02H		

Operating Systems
Terminal Board Firmware

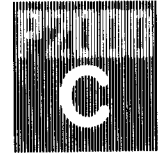

In the following diagram the standard ASCII table is annotated to show the effect of using the CTRL key with any key-produced code. For example, the codes associated with any of the keys '7', 'W' or 'w' (37, 57 or 77) would produce the CONTROL code '17' (ETB), which is not used in the P2000C Basic I/O System.

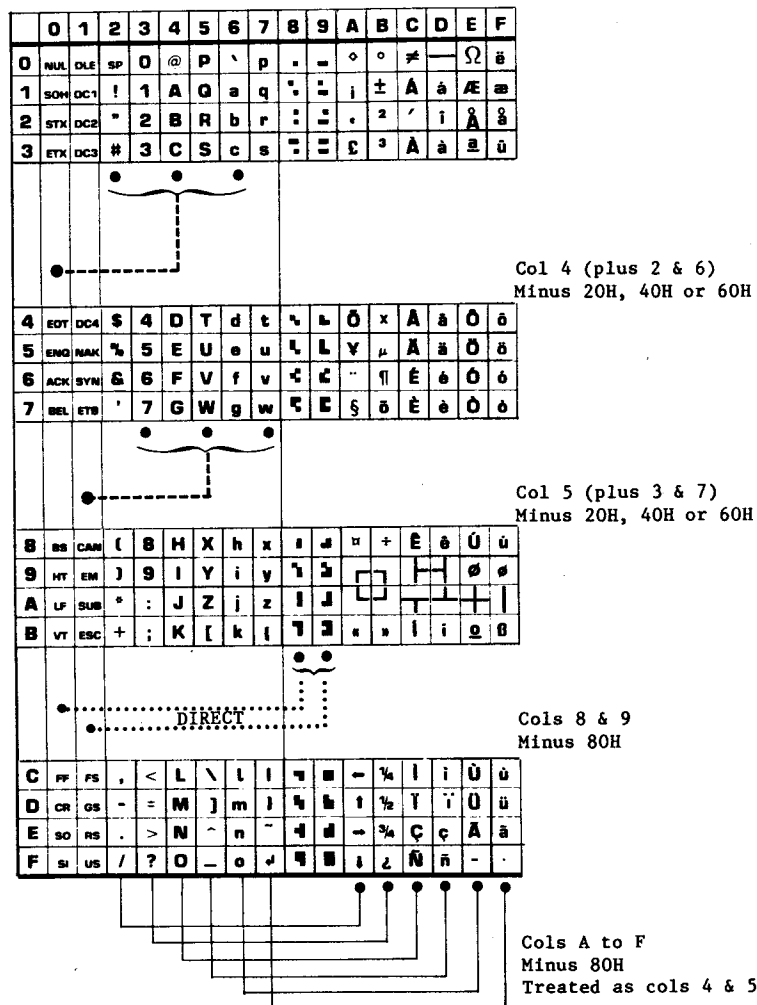

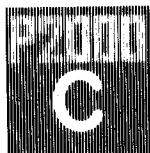

Operating Systems
Terminal Board Firmware

2.3.2. ESCAPE SEQUENCES - SET ATTRIBUTE

SET ATTRIBUTE = ESC,0,b

where b=attribute byte
and 0=numeric zero

An attribute can be set at any time and is valid until a new attribute is selected.

- Attributes: Underline - UL
- Blink - BL
- Invert - INV
- 4 Intensities
- res - reserved

Attribute byte:	res	in1	UL	INV	res	res	BL	in2
	---	---	---	---	---	---	---	---
bit:	7	6	5	4	3	2	1	0
	0	0	0	0	0	0	0	0
Intensities	in1		in2					
Quarter bright	0	0	0	0				
Bold	0	1	0	0				
Normal	1	0	0	0				
Half bright	1	1	0	0				

For example, the ESCape sequence ESC,0,99 (or ESC,0,&H63) would cause screen characters to be produced:

- half brightness
- underlined
- blinking

Note: To execute ESCape sequences it is necessary to use the CHR\$(27) code.
All ESCape sequences in the following pages can be carried out in this way. The above example could be included in a BASIC program in the following way:

```
PRINT CHR$(27)+"0"+CHR$(&H63)
```

or

```
PRINT CHR$(27)+"0"+CHR$(99)
```

Operating Systems
Terminal Board Firmware

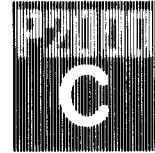

2.3.3 ESCAPE SEQUENCES - SCREEN CONTROL

A C T I O N	Code	ASCII
Cursor Addressing	ESC,Y,r,c	Y=59H/89
r = row	= 0 to 23 (+20H offset)	
c = column	= 0 to 79 (+20H offset)	
Erase to End of Line	ESC,K	K=4BH/75
Erase to End of Screen	ESC,k	k=6BH/107
Scroll Up one Line	ESC,S	S=53H/83
Scroll Down one Line	ESC,T	T=54H/84
Set TAB at Cursor Position	ESC,I	I=49H/73
Clear TAB at Cursor Position	ESC,G	G=47H/71
Clear all TABs	ESC,g	g=67H/103
Insert Line	ESC,L	L=4CH/76
Delete Line	ESC,l	l=6CH/108
Insert Character at		
Cursor Position ON	ESC,Q	Q=51H/81
OFF	ESC,R	R=52H/82
Delete Character at		
Cursor Position	ESC,P	P=50H/80
Insert Character		
Wrap-around ON	ESC,N	N=4EH/78
OFF	ESC,R	R=52H/82
Delete Character		
Wrap-around	ESC,O	O=4FH/79
Back TAB	ESC,i	i=69H/105
Cursor Visible	ESC,C	C=43H/67
Cursor Invisible	ESC,c	c=63H/99
Start Teletext Graphic	ESC,l	l=31H/49
End Teletext Graphic	ESC,2	2=32H/50
Lock Area for Scrolling	ESC,A,n	A=41H/65
	n=number of lines	
Unlock Area from cursor	ESC,a	a=61H/97
Unlock all Areas	ESC,u	u=75H/117
Send Status	ESC,?	?=3FH/63
Send Text from Cursor Position	ESC,\$,nn	\$=24H/36
	nn=number of characters	
Send Attributes of Text		
from Cursor	ESC,%,nn	%=25H/37
Load User Program	ESC,p	p=70H/112
(in INTEL HEX format)		
End of INTEL HEX Format	ESC,:	:=3AH/58
(exits loader, normal operation)		
Execute User Program	ESC,x	x=78H/120
Load New Keyboard Table	ESC,@	@=40H/64
Load New Screen Table	ESC,!	!=21H/33
Define Caps Lock Key	ESC,+,k,nn	+ =2BH/43
	(k=key,nn=upper limit (Hex))	

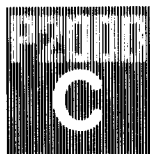

Operating Systems
Terminal Board Firmware

2.3.4 DESCRIPTION OF CONTROL CODES

Cursor home:	New cursor position is column 1/row 1.
Cursor forward:	Column + 1.
Cursor down:	New line. Scroll if last line or beginning of a locked area.
Cursor up:	One line up. If 1st line then new position is the bottom line.
Cursor back:	Column - 1.
Backspace:	Same as cursor back.
TAB:	Cursor to next TAB position, default every eighth column.
Clear screen:	Erase the whole screen, cursor at home position.
CR:	Cursor at column 1 in current line.
End of page:	New cursor position is column 80 and row 24
Reset terminal:	Initialise hardware and software. After RESET allow 500ms before sending data to terminal.
Lock keyboard:	All keyboard inputs are ignored.
Unlock keyboard:	Keyboard entries are re-enabled.
Reset:	Re-initializes the hardware and software.
Set attribute:	A new attribute is used until the next "Set attribute" command.
Cursor address:	Absolute cursor address with an offset of 20H (ESC,Y,20H,20H is the "home position").
Erase to end of line:	Clear all characters including cursor position to column 80.
Erase to end of screen:	Same as "Erase to end of line" to column 80, row 24.
Scroll up 1 line	Scroll up the whole screen or area and clear last line.
Scroll down 1 line	Same as above, but scroll down.
Set TAB:	Sets a new TAB position at cursor position.
Clear TAB:	A TAB position is removed at cursor position.
Clear all TABs:	Removes all TABs.
Insert line:	Scroll down the lines from cursor line + 1, and clear cursor line.
Delete line:	Scroll up the lines from cursor line +1 to cursor line.
Insert ON:	The next character will be inserted at cursor position, the last character in the line will be lost.
Insert wrap-around:	Same as "Insert" but the last character of the screen will be lost.
Insert OFF:	Exit insert mode, normal overwrite.
Delete character:	Delete character at cursor position, the last character in the line will be a blank.
Delete character wrap around:	Same as "Delete character" but last character of screen will be blank.

Operating Systems
Terminal Board Firmware

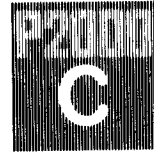

Back TAB: New cursor position is previous TAB position.
Cursor visible: Display cursor.
Cursor invisible: Do not display cursor.
Start Teletext graphic: All characters between 20H & 3FH, and 60H & 7FH are interpreted as teletext characters.
End Teletext graphic: Normal character mode.
Lock area: From cursor line, n lines will be locked. (This area will not be scrolled by Cursor up and down, only by explicit "Scroll up (down)" command. (See Scroll Lock explanation on following pages).
Unlock area: The cursor position area is unlocked.
Unlock all: Normal screen status.
Send status: 12 bytes terminal status information will be sent (see STATUS INFORMATION).
Send text: nn characters from cursor position will be sent back.
Send attribute: nn attribute bytes from cursor position will be sent.
Load user PGM: This function enters a built in INTEL-HEX FORMAT loader. The load address may be anywhere in the free RAM areas (see Memory layout). To find RAM FREE TO USE use the STATUS command (ESC,'?'). The terminal remains in the LOADER until it recognises an ESC,':' after a valid INTEL_HEX FORMAT record. If loading is finished, normal terminal operation is possible.
End loader: Exits the loader, enables normal operation.
Execute PGM: This function makes a CALL to the previously loaded user program. The user program entry address is defined by an INTEL_HEX FORMAT record with record-type '01'. Ensure that the loaded program has such a record, otherwise a CALL to the location '0' will be performed (RESET). Only the last '01' record is valid. The user program should exit via a 'RET' instruction, making a normal return to the terminal program.
Load new keyboard table: Loads the following 360 bytes into the internal keyboard table. It consists of 4 90 byte sub-tables (NORMAL, SHIFT, SUPER SHIFT, SUPER SHIFT-SHIFT) (see STANDARD KEY TABLE).
Note: If CONTROL is pressed, all key codes are logically ANDed with 1F.
Load new screen table: Loads the following 256 bytes into the internal screen table.
Define Caps Lock key: The key K is the new caps lock key. There is no default key.



Operating Systems
Terminal Board Firmware

SCROLL LOCKED AREAS

Normally, all 24 lines of the screen will be scrolled by a LINE FEED on the last line or by an explicit SCROLL UP - SCROLL DOWN command. For some applications it is useful not to scroll the whole screen e.g., in word processing (tab - format line). On the P2000C it is possible to lock certain areas of the screen, or the whole screen, from automatic scrolling. This is done with the command ESC,'A',n. It locks n lines, starting with the cursor line. Normal scrolling is still possible with the explicit SCROLL UP - SCROLL DOWN commands.

EXAMPLES

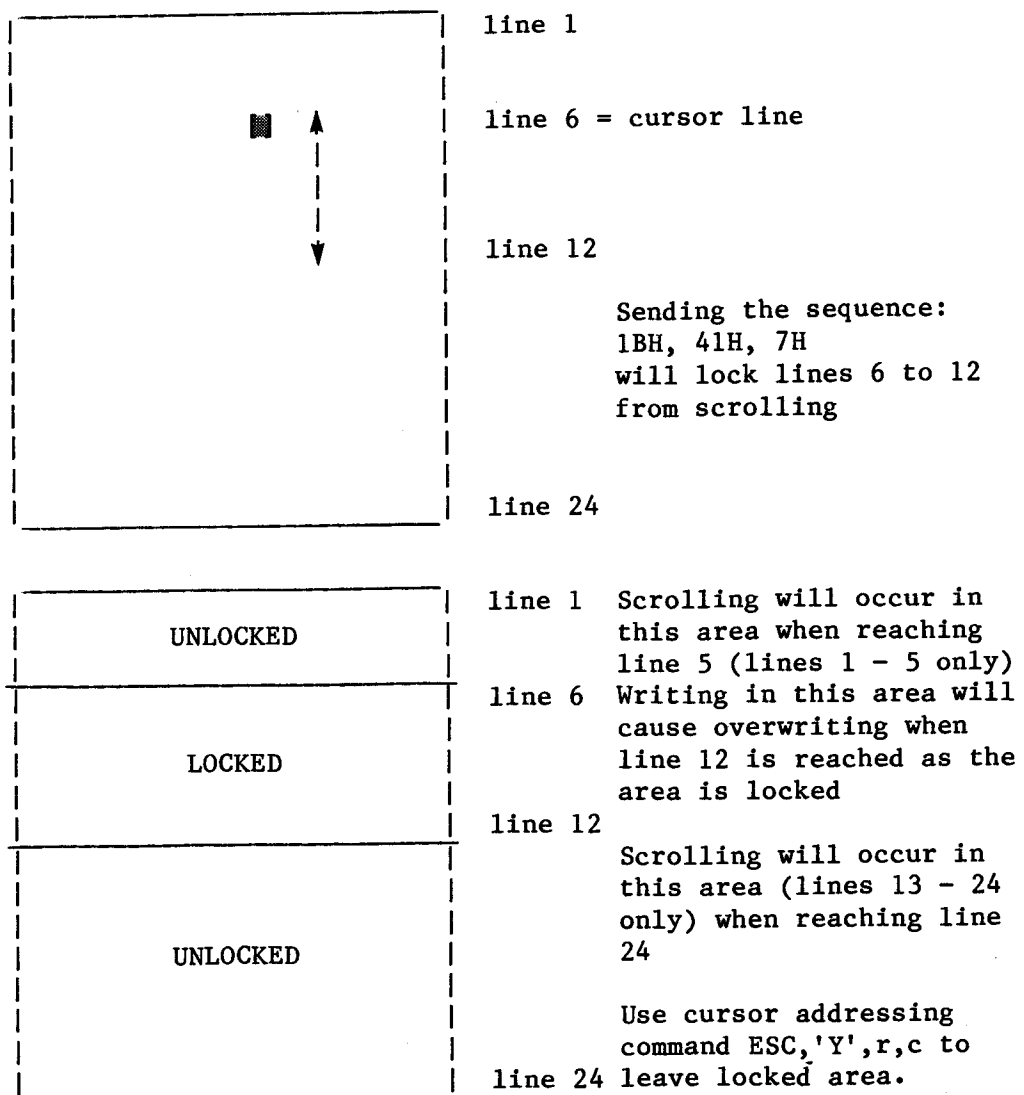

Operating Systems
Terminal Board Firmware

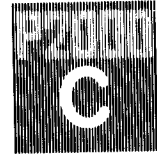

ALLOCATING MORE SCROLL LOCKED LINES

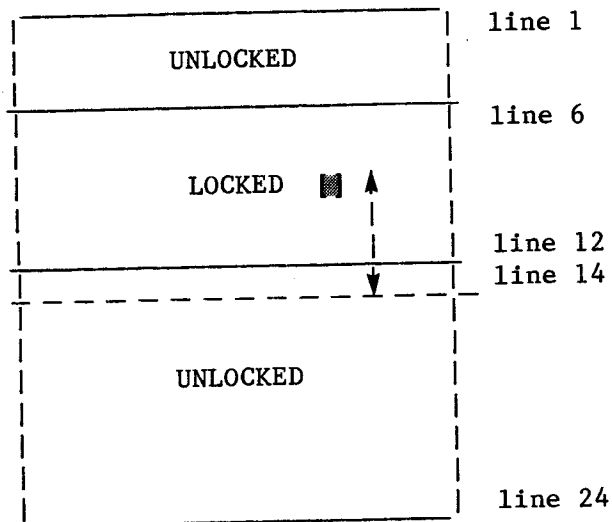

If sequence 1BH,41H,5H with cursor in line 10, the lines 10 - 14 will be locked. As lines 10, 11 and 12 are already locked, the locked area will simply be increased

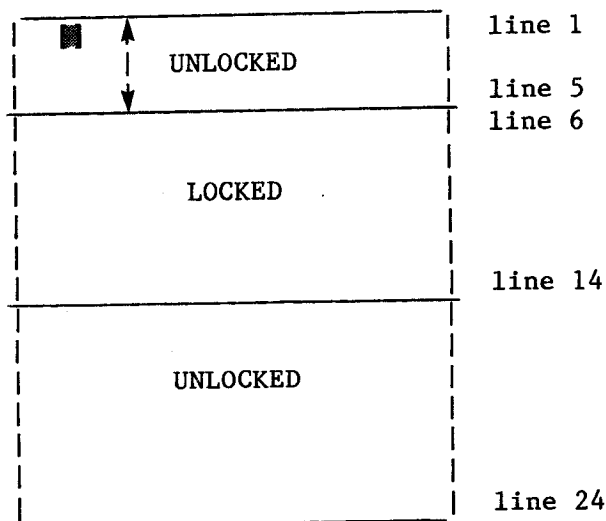

Locking additional 5 lines from line 1 (1BH,41H,5H) will lock all lines from 1 - 14. Only 15 - 24 are now unlocked.



Operating Systems
Terminal Board Firmware

LAST PART OF THE SCREEN IS LOCKED

UNLOCKED	line 1	
	line 5	
LOCKED		
	line 10	
UNLOCKED		
	line 17	
LOCKED		
	line 24	

If the cursor is anywhere in the locked area at bottom of the screen, writing in bottom line will cause the cursor to move to the top of the screen. The same effect is seen when the whole screen is locked.

The UNLOCK command will unlock the complete area containing the cursor. If the cursor is in an unlocked position when the command is given it has no effect.

Operating Systems
Terminal Board Firmware



2.3.5 GRAPHIC CONTROL

ACTION	Code	ASCII
Start high resolution mode 1 (256 x 252)	ESC,5	5=35H/53
Start high resolution mode 2 (512 x 252)	ESC,3	3=33H/51
Start character mode (end graphics)	ESC,4	4=34H/52
CARTESIAN CO-ORDINATES:		
Clear dot	ESC,d,xy	d=64H/100
Set dot	ESC,D,xy	D=44H/68
Move to	ESC,m,xy	m=6DH/109
Draw to	ESC,M,xy	M=4DH/77
Clear to	ESC,v,xy	v=76H/118
POLAR CO-ORDINATES:		
Set origin	ESC,z,xy	z=7AH/122
Move to	ESC,y,Aabs	y=79H/121
Draw to	ESC,U,Aabs	U=55H/85
Clear to	ESC,w,Aabs	w=77H/119
Set dot	ESC,F,Aabs	F=46H/70
Clear dot	ESC,f,Aabs	f=66H/102
Send picture (to screen)	ESC,r,xy,nn	r=72H/114
	nn=number of bytes	
Receive picture (main processor)	ESC,t,xy,nn	t=74H/116

Note: xy = co-ordinates: 2 bytes in mode 1
3 bytes in mode 2
(low 'x' byte first, i.e., x(low), x(high), y)

Aabs = A + abs:

A = angle ALPHA (2 bytes)
abs = absolute value (2 bytes)

In commands, Aabs parameters (4 bytes) are as follows:

byte 1 = A MOD 256
byte 2 = INT(A/256)
byte 3 = abs MOD 256
byte 4 = INT(abs/256)

It should be noted that any movement of data from the screen as in, e.g., Send/Receive Picture, Get Status commands etc., may result in the generation of code 90H. This could be interpreted by the Terminalboard as a Print Screen command. It is advisable to disable the Print Screen function where this could be inconvenient.



Operating Systems
Terminal Board Firmware

Angle ALPHA "A" is in steps of one degree (0 to 360).

Defining angle "A"; 2 bytes (low order byte FIRST in command)
 low order byte: = A MOD 256
 high order byte: = INT(A/256)

Defining value "abs"; 2 bytes (low order part FIRST in command)
 low order byte: = abs MOD 256
 high order byte: = INT(abs/256)

DESCRIPTION OF SEND/RECEIVE PICTURE

In either of the high resolution graphics modes, an area of the screen can be stored for rapid retrieval by using the ESC r & t sequences.

The sequence ESC,t,xy,nn (defined as Receive Picture - the main processor 'receives' the information) defines the first co-ordinate of the screen image to be stored (xy) and the number of bytes to be stored (nn). Remember that in the 512 X 252 resolution mode the 'x' co-ordinate requires 2 bytes. The number of bytes must be calculated at 64 bytes for each complete line to be stored. The first byte to be stored is calculated from the xy co-ordinates, rounded down to ensure that the full picture is stored.

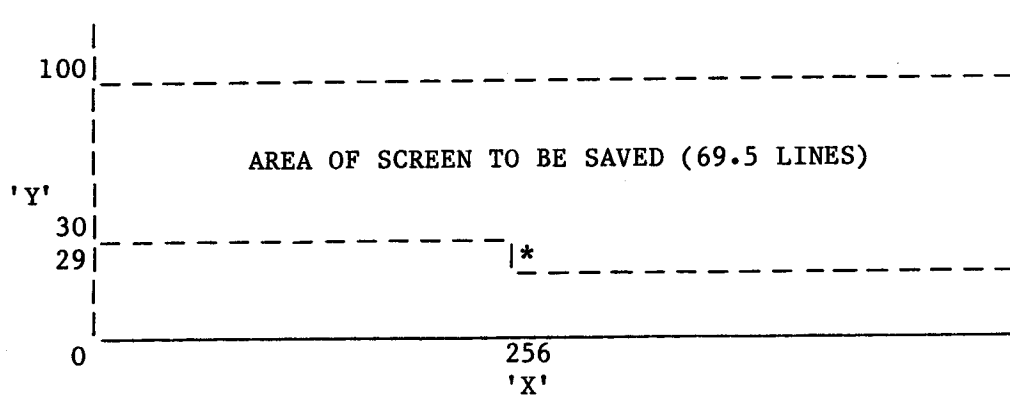

```
ESC, 't', 0 ,1 ,29, (69.5 x 64)
           x1 ,x2 ,y , n1 , n2
1BH, 74H, 0 ,1 ,29, 96 , 17
```

The sequence ESC,r,xy,nn (defined as Send Picture - the main processor 'sends' the information to the terminal) defines the start position of the picture on the receiving screen (xy) and the number of bytes to be transferred (nn).

```
ESC, 'r', 0 ,1 ,29, (69.5 x 64)
           x1 ,x2 ,y , n1 , n2
1BH, 72H, 0 ,1 ,29, 96 , 17
```

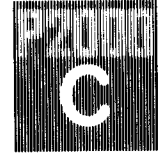

Operating Systems
Terminal Board Firmware

EXAMPLE PROGRAM SHOWING SEND/RECEIVE PICTURE USING ZSID

```

4000 LD HL,5000  nr. of bytes to be printed (stored at 5000H)
4003 LD B,(HL)
4004 INC HL
4005 LD C,(HL)  get next data byte
4006 PUSH BC   save register
4007 PUSH HL   save register
4008 CALL F60C print (on console)
400B POP HL   restore register
400C POP BC   restore register
400D DJNZ F5 (4004)loop for all bytes to be printed
400F NOP
4010 NOP
4011 LD C,04   number of bytes to read back from screen (410hex)
4013 LD B,10
4015 LD HL,6000 write bytes from screen to memory starting at address 6000
4018 PUSH BC   save register
4019 PUSH HL   save register
401A CALL F609 get one byte from screen
401D POP HL   restore register
401E POP BC   restore register
401F LD (HL),A save byte from screen to next free location
4020 INC HL   move to next location
4021 DJNZ F5 (4018)loop for all bytes requested
4023 LD, B,FF  next 256 bytes
4025 DEC C    until register C contains 0
4026 LD A,C
4027 CP FF
4029 JR NZ,ED (4018)
402B NOP
402C NOP
402D NOP
402E NOP
402F NOP
4030 NOP
4031 LD C,04   nr. of bytes to be printed (416hex)
4033 LD B,16
4035 LD HL,5FFA start printing bytes at address 5FFA
4038 PUSH HL   save register
4039 PUSH BC   save register
403A LD C,(HL) print byte, addressed by register HL
403B CALL F60C
403E POP BC   restore register
403F POP HL   restore register
4040 INC HL   move to next location until all characters are printed
4041 DJNZ F5 (4038)
4043 LD B,FF
4045 DEC C
4046 LD A,C
4047 CP FF
4049 JR NZ,ED
404B .        stop program here (set a breakpoint, or execute a return)
    
```

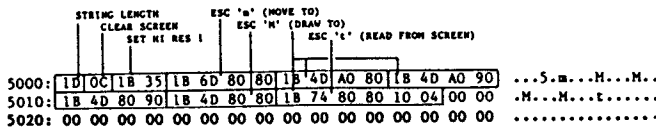

data to enter high resolution mode 1, clear screen and draw a rectangle about in the middle of the screen

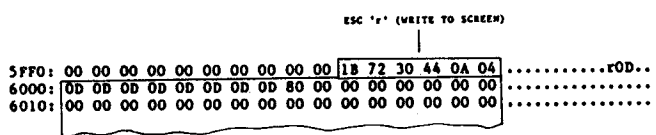

read back the picture and store it in the memory starting at address 6000

'PICTURE' IN MEMORY

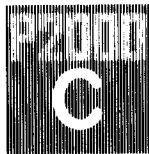

Operating Systems
Terminal Board Firmware

2.3.6 DESCRIPTION OF GRAPHIC COMMANDS

Start mode 1: Start 256 x 252 resolution mode with 3 intensity levels. The change of this level is done by "Set attribute" command.

Start mode 2: Start the 512 x 252 resolution mode.

Start character mode: Exit high resolution graphic mode 1 or 2.

CARTESIAN COORDINATES

Clear dot: Erase pixel at screen position xy.

Set dot: Set a pixel at xy.

Move to: Set the internal cursor field to xy.

Draw to: Draw a line from internal cursor field to xy, and set the internal cursor field to xy.

Clear to: Same as "Draw to" but the line is erased.

POLAR COORDINATES

Set origin: Set the internal origin field to xy.

Clear dot: Erase a pixel at A (angle), abs (absolute value) with respect to the origin.

Set dot: Same, but set the pixel.

Move to: Set the internal cursor field to the calculated (using A abs, origin) value xy.

Draw to: Draw a line to the calculated value xy and set internal cursor field to xy.

Note: Any combination of POLAR and CARTESIAN coordinates is possible!
After a "Start" command the graphic screen is cleared (but not the character part), the internal cursor field and the origin field are set to 0.

On the following page is an example of a simple Basic program using polar co-ordinates in High Resolution Mode 2. This shows the use of some of the Graphic Control ESCAPE sequences given in 2.3.5. A more sophisticated example of the program is given in Appendix B of the manual.

Operating Systems
Terminal Board Firmware

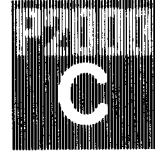

2.3.7

EXAMPLE - BASIC PROGRAM USING POLAR CO-ORDINATES

```

1 'simple test program for polar co-ordinates
2 '-----
10 DEFSTR E:ESC=CHR$(27):PRINT CHR$(12)
11 PRINT ESC"c" 'cursor invisible
12 PRINT ESC"3" 'high resolution mode 2
13 PRINT ESC"z"CHR$(0)CHR$(1)CHR$(126) 'set origin polar
14 PRINT ESC"y"CHR$(0)CHR$(0)CHR$(0)CHR$(0) 'move to origin
15 V=V+15:IF V=126 THEN 27 'setting of value V
16 V1=INT(V/256):V2=V MOD 256 '2 byte calculation of value
17 '-----
18 IF F=0 THEN S=14 ELSE S=45 'setting of step rate
19 FOR A=0 TO 360 STEP S 'start loop in degrees
20 A1=INT(A/256):A2=A MOD 256 '2 byte calculation of angle
21 PRINT ESC"U"CHR$(A2)CHR$(A1)CHR$(V2)CHR$(V1) 'draw to command
22 IF F=1 THEN 24
23 PRINT ESC"y"CHR$(0)CHR$(0)CHR$(0)CHR$(0) 'move to origin
24 IF F=0 THEN 25 ELSE FOR T=1 TO 50:NEXT T
25 NEXT A:GOTO 13 'end of loop
26 '-----
27 IF F=1 THEN 28 ELSE F=1:V=5:GOTO 12
28 F=0:V=5:GOTO 12

```

2.3.8

Description of Graphic RAM

512 X 252 MODE

In this mode, 1 byte represents 8 pixels, each pixel consisting of ONE screen dot. When a bit is ON (1) the corresponding pixel is visible. The msb (most significant bit) of each byte relates to the leftmost screen pixel. The first 64 bytes of graphic RAM (C000H to C03FH) represent the first (top) line of the screen, 64 x 8 giving the 512 pixels in each line.

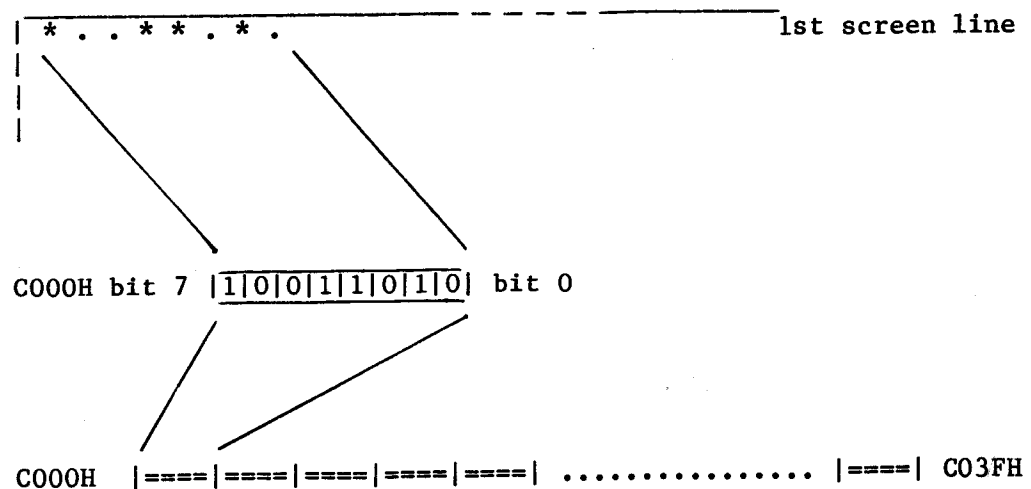



Operating Systems
Terminal Board Firmware

256 X 252 MODE

In this mode, 1 byte represents 4 pixels, each pixel consisting of TWO adjacent screen dots. The first 64 bytes of graphic RAM (C000H to C03FH) represent the first (top) line of the screen, 64 x 4 giving the 256 pixels in each line. Each pixel is defined by 2 bits, with the msb (most significant bit) and msb minus 4 relating to the leftmost screen pixel. The values of these two bits determine the pixel intensity, i.e.,

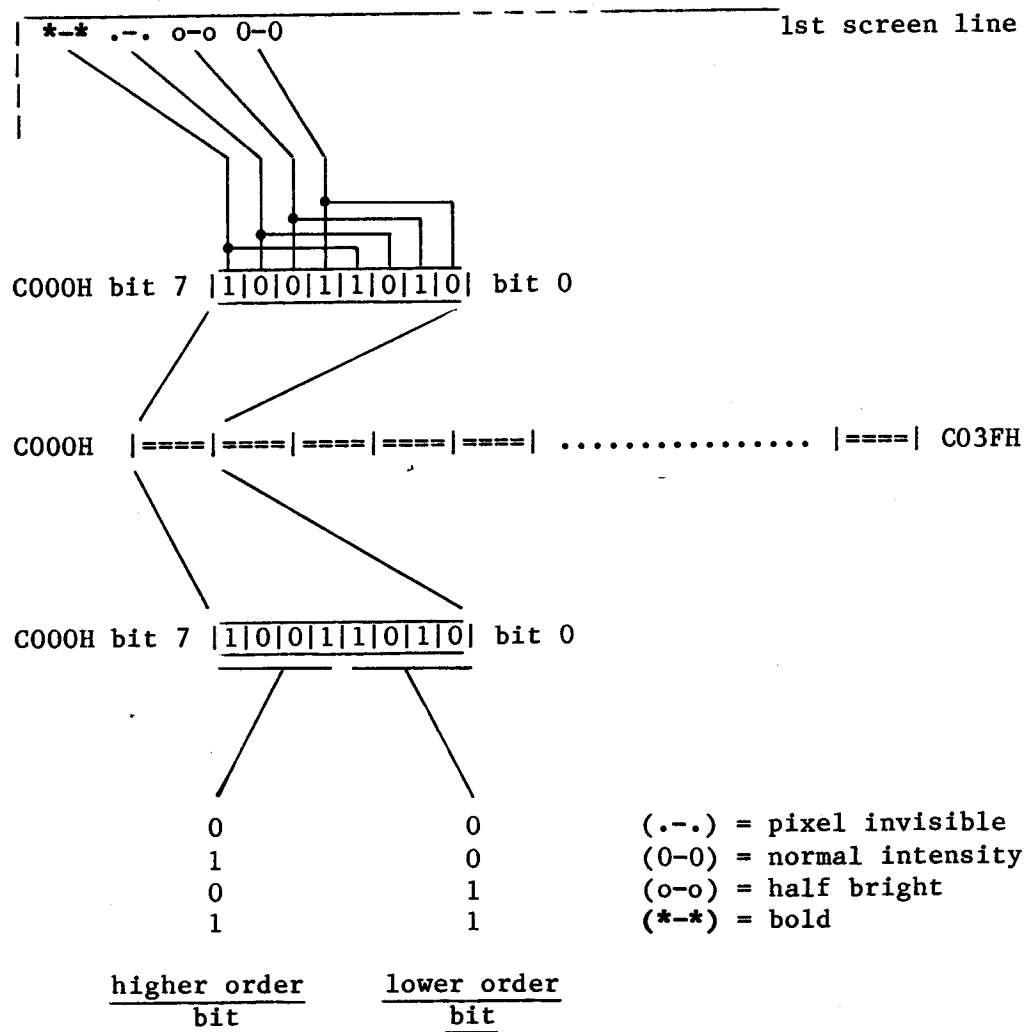

Operating Systems
Terminal Board Firmware



2.4 Status Information

The terminal status information is given in the form of a 12 byte string, as shown below:

Byte Number	Contents
1	cursor position - column
2	cursor position - row
3	character at cursor position
4	status flag
	Bit:
0	1 = graphics on
1	1 = graphic mode 2
2	1 = teletext on
3	1 = insert mode on
4	1 = insert wrap around on
5	1 = keyboard is locked
6	reserved
7	reserved
	internal graphic cursor field
5,6	x co-ordinate
7	y co-ordinate
8,9	free space pointer (beginning of RAM area for user program)
10,11,12	reserved for future use



Hardware Configuration and Peripheral Extensions

1-1

1 HARDWARE CONFIGURATION

This chapter describes the Philips P2000C system hardware configuration. (For a description of the peripherals consult the appropriate peripheral reference manual). This chapter includes a description of the mechanical construction, electronic design, environmental conditions for storage and operation and power supplies.

1.1 INSTALLATION

After unpacking the basic P2000C, installation is simply a matter of connecting the keyboard to the main unit and then connecting the system to a suitable power supply. It should be confirmed that the voltage and frequency of the supply meets the requirements of system and any peripheral units that are to be connected. With the exception of the keyboard, all parts of the system are internally connected. Any additional units will be connected to the rear of the main unit by cables.

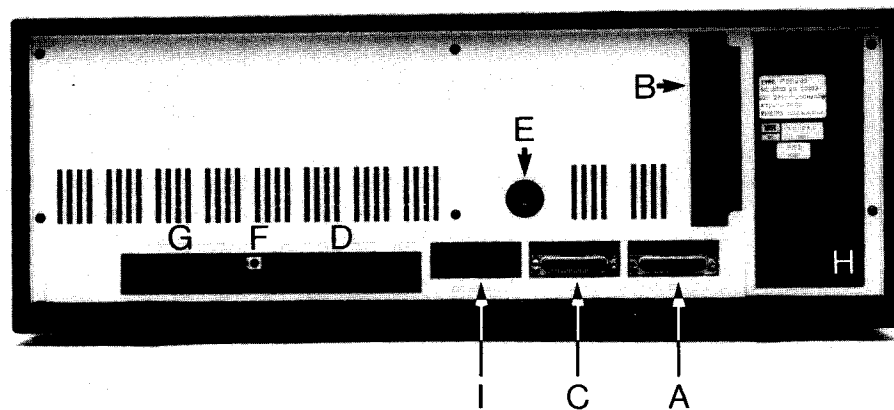

Figure 1.1 P2000C Rear Panel

Explanation of lettered items:

- | | |
|--|---------------------------|
| A - Printer connection | B - Position of extension |
| C - Communications connection | (i.e., IEEE) connector |
| D - Hard disk connection | E - External video output |
| F - Common earth for peripherals | |
| G - Connection to the external disk drives | |
| H - Mains power supply (inside compartment) | |
| I - Position of external terminal connection | |

Hardware Configuration
and Peripheral Extensions



1.1.1 Connecting The Mains Supply

The P2000C contains an integral power unit. A cable is provided to connect the power supply to a suitable mains outlet. The keyboard is provided with power from the main unit via the connecting cable. Separate mains cables will be required for any peripherals (printer etc.). Mains cables are provided appropriate to the local conditions.

As soon as power is applied, by pressing the POWER ON/OFF switch, the system performs the IPL program and attempts to bootload the system software from a system disk. Failure to find suitable information (i.e., disk drive open) will result in a 'SYSTEM DISK?' message. Pressing the RESET switch on the front of the unit, or any key, will cause the IPL operation to be repeated.

1.1.2 Earthing

It is essential for safe operation that all components are connected to an earthed mains supply. Also, to remove the risk of errors caused by different earth potentials, all system hardware components must have a common ground. Two ground connections are provided on the rear panel for use of the printer or other peripherals.

1.1.3 Adjustment of Power Supply

Your P2000C will be set to the correct voltage for your district at manufacture. If it is necessary to alter the voltage, please refer to Part 3, Chapter 1.

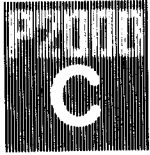

Hardware Configuration and Peripheral Extensions

1.1.4 Optional Extensions

An important feature of the P2000C is the extension capability of the basic unit. It is possible to add either:

- IEEE Board
- RAM-Floppy Board

The procedure for fitting these boards is detailed in Part 4 of this manual and should be followed carefully.

1.2 MECHANICAL CONSTRUCTION

The P2000C is a portable desk-top microcomputer. It consists of a main cabinet containing monitor and disk drives with a keyboard attached by a cable to the side of the basic unit. Other system components that may be attached to the unit include additional disk drives, a printer and a second monitor.

Hardware Configuration
and Peripheral Extensions

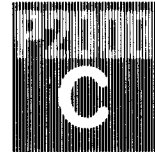

1.2.1 Dimensions of System Components

P2000C (including keyboard)

width	540mm
depth	360mm
height	210mm
weight	15.4 kg

1.2.2 Cable Specifications and Lengths

Mains power lead (including moulded plug)

length	1.8 metres
type	earthed mains lead
no. of cores	3

Main unit to Keyboard

length	1.3 metres
type	6-pole DIN 45 322 (240°)
no. of cores	6 + screen

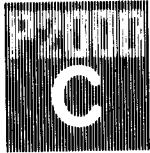

Hardware Configuration
and Peripheral Extensions

1.3

SAFETY

The P2000C is a Class I equipment and meets the following safety standards:

- IEC Publication 435, Draft 1983
 - Safety of data processing equipment

- ÖVE-EM 42 part 1, dated 1970 & part 2(1600)dated 1974
 - Requirements for electrically energised equipment for domestic use and similar purposes.
 - part 1/1970 General requirements
 - part 2(1600)/1974 Office machines

Hardware Configuration
and Peripheral Extensions

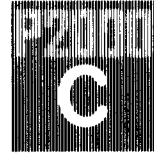

1.4 ENVIRONMENTAL CONDITIONS

The environmental constraints imposed on the Philips P2000C microcomputer are in line with those for Philips office equipment, and should allow the equipment to function in a standard office environment as specified in Data Systems Environmental Standard, anywhere in the world without modification. If local operating conditions are outside these limits, then the local Philips service organization should be contacted. In addition, local office safety regulations may affect equipment operation, e.g., a limit on the time a user can continuously operate with a monitor.

1.4.1 Conditions for Storage of Components

The storage temperature and humidity figures for the individual system components are given in table 1.1. These figures assume that the combined rate of temperature and humidity changes preclude condensation on any part of the unit or media. Air transport under unpressurised conditions can take place at altitudes of up to 6300 metres.

1.4.2 Transportation Constraints

When packed for shipment the system components will suffer no degradation in performance when subject to shock and vibration in the x, y and z axis (within the limits set out below).

- continuous vibration (i.a.w. IEC 68)
 - 10 through 58 Hz maximum 0.3 mm amplitude (peak-to-peak)
 - 58 through 150 Hz maximum acceleration or deceleration of 19.62 m/sec^2 (2g) in 3 axes, 1.5 hr/axis - sweep 1 octave per minute.
- intermittent shocks
 - up to 49.15 m/sec^2 . (5g)
and not exceeding 11 milliseconds duration.

The transportation and packaging materials used should ensure that the system components are not exposed to environmental conditions which are more extreme than those specified for storage.

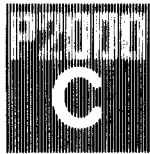

Hardware Configuration and Peripheral Extensions

1.4.3 Conditions for Operation of Units

The system components will operate in environments where the conditions are within the ranges specified in table 1.1. These figures assume that the combined effect of temperature and humidity changes preclude condensation in any part of the unit or on any storage or printing media.

Table 1.1 Conditions for Storage and Operation of Units

temperature range - storage	-40°C to 70°C
- operating	10°C to 35°C
- disks	10°C to 52°C
max temperature change rate	
- storage	5° per minute
- operating	.5° per minute
relative humidity - storage	5% to 95%
- operating	20% to 80%
absolute humidity - storage	less than 35 grms per cubic metre
- operating	3 to 20 grms per cubic metre
max dew point temperature	28°C
atmospheric pressure	
- storage	45kPa to 110kPa
- operating	70kPa to 110kPa
	normal max altitude
	2900 metres
non-conductive dust particle size	0.5/m 4.10 part/m
	1/m 4.10 part/m
	5/m 4.10 part/m
gaseous pollution	continuous exposure to sulphur dioxide and hydrogen sulphide open air concentrations of 0.1 ppm will not adversely affect the operation of equipment
sea proximity	the equipment has been operated with an air concentration of up 2.7/ug of salt (NaCl) per cubic metre of air

Note: Do not expose the P2000C to strong sunlight.

Hardware Configuration
and Peripheral Extensions

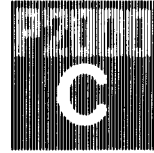

SHOCK AND VIBRATION

When operating within a system, the components are able to perform as specified while being subjected to the following shock and vibration limits:

- continuous vibration (i.a.w. IEC 68)
 - 10 through 58 Hz maximum 0.15 mm peak-to-peak
 - 58 through 150 Hz maximum acceleration or deceleration of 1.96 m/sec^2 (0.2g) and 9.81 m/sec^2 (1.0g) in 3 axes, 2.0 hr/axis - sweep 1 octave/minute

- intermittent shocks
 - up to 9.81 m/sec^2 (1g) and not exceeding 11 milliseconds duration. No shock is to be repeated more than twice per second.

1.4.4 Electromagnetic Constraints

The system components meet the EEC, EFTA and German standards for high frequency appliances.
Tested against Funk-Störvorschrift ÖVE F62, Klasse B.)

1.4.5 Electrostatic Constraints

The system components and total system have been designed in such a way as not to be harmed by static discharge during normal operation, although users should ensure that they do not have a static charge before touching PCB's.

1.4.6 Positioning of P2000C

The P2000C is designed to operate correctly on a table-top, with the tilt-bar extended to improve the viewing angle. If the equipment is used with the tilt-bar folded, adequate space should be allowed for air convection. Under no circumstances should it be operated in any other position, which could interfere with the operation of the disk drives.



Detailed Description and Servicing
Introduction

1

GENERAL

The P2000C consists of the following main units:

- Power Supply Unit and Distribution Board
- Mainboard
- Terminalboard
- 9" Monitor
- Two 5½" Flexible Disk Drives (160 Kbytes or 640 KBytes)
- Keyboard

With the exception of the Keyboard, all the units are contained within the main casing.

The integration of the various units is shown in the following block diagram:

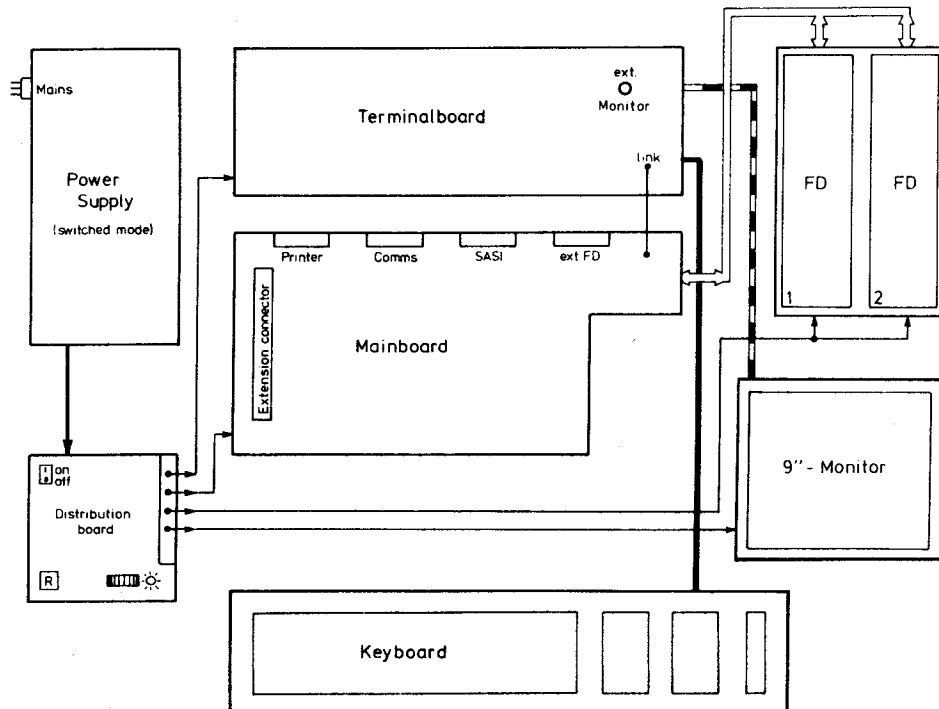

Detailed Description and Servicing
Introduction

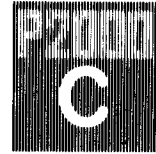

2 P2000C 12NC NUMBERS

To clarify the significance of the numbers that you will find on PCB'S inside the unit, an example is shown below.

2.1 Example

The component side of the Mainboard, shown on the following page, has the numbers:

- a) 5103 103 3114.1
- b) 8203 235 0591.1
- c) 8203 235 0594.1
- d) 8203 235 0593.1
- e) 0271.1

These numbers should be interpreted in the following way:

- a) Read as 5103 103 3114 'point' 1 (medium significance)
This is the number of the printed board, the 1 following the point representing the status of the printed board.
 - b) Read as 8203 235 0591 'point' 1 (low significance)
This is the number of the component side layout, once again the digit following the point representing the status of the layout.
- Both of the above numbers are etched onto the board in the same way as the printed track.
- c) Read as 8203 235 0594 'point' 1 (low significance)
This is the number, including status (point number), of the Service Printout. It is printed in white on the board.
 - d) Read as 8203 235 0593 'point' 1 (low significance)
This is the number, including status (point number), of the solder resist varnish layout. This number is stamped into the varnish.
 - e) Read as (5103 108) 0271 'point' 1 (high significance)
This number, the ASSY NUMBER, with the implied 5103 108, represents the 12 NC number of the complete assembly. The point number gives the status of the assembly. This number is printed on a white 'stick-on' label.
The 'point number' of each main assembly is repeated on the Service Sticker on the outside of the P2000C.

The numbers described at b) and d) above are also found on the solder side of the PCB.



Detailed Description and Servicing
Introduction

2.2 Service Sticker

The Service Sticker, shown below, is attached to the underside of the P2000C. It is used to indicate the modification status of all the main assemblies incorporated in the machine. The modification status should be taken as the highest number 'blocked-out'. This number corresponds to the 'point-number' in the ASSY number (see 2.1, e).

P2000C PORTABLE COMPUTER



PHILIPS

UNIT	MODIFICATION	SERVICE	UNIT	MODIFICATION	SERVICE
MONITOR	● 2 3 4 5 6 7 8 9		TERM.-PCB	1 ● 3 4 5 6 7 8 9	
POWER SUPPLY	● 2 3 4 5 6 7 8 9		KEYBOARD-PCB	1 ● 3 4 5 6 7 8 9	
DISTRIBUT.-PCB	● 2 3 4 5 6 7 8 9		EXTENS.-PCB	1 2 3 4 5 6 7 8 9	
MAIN-PCB	1 2 ● 4 5 6 7 8 9			1 2 3 4 5 6 7 8 9	

5103 106 0707.3

The above example would represent a P2000C containing:

- Monitor Status 1 - release status
- Power Supply Status 1 - release status
- Distribution PCB Status 1 - release status
- Mainboard PCB Status 3 - two modifications incorporated
- Terminalboard PCB Status 2 - one modification incorporated
- Keyboard PCB Status 2 - one modification incorporated
- Extension PCB Not fitted

Detailed Description and Servicing
Introduction

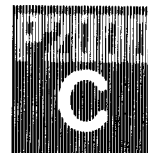

THIS PAGE INTENTIONALLY BLANK



Detailed Description and Servicing
Power Supply

1 GENERAL

The P2000C Power Supply Unit has been designed to be serviced by replacement at first line, with factory repair facilities. For this reason this chapter will only outline the basic specification of the unit to give information for testing, on a GO/NO GO basis.

2 SPECIFICATION

Nominal output power: 82 W
 AC input voltage 90 - 140V 47-66 Hz
 (selectable by jumper): 180 - 264V 47-66 Hz
 DC output voltages:

REF VOLTAGE	ON PINS	GND PINS	Remarks
V1 +5	11,12,13	8,9,10	TTL supply voltage 2 - 6A, +/- 3%
V2 +12	6,7	4,5	0.1 - 2.8A, +/- 5% maximum 3.8A for less than 40 ms, +/-10%
V3 +12	3	4,5	Monitor supply voltage 0 - 1.2A, +/- 1% (series regulated) ripple synchronous to mains frequency must be less than 30mV peak to peak.
V4 -12	2	4,5	RS 232 supply voltage 0 - 0.3A, +/- 5%
Ripple and noise			2% max (except V3)
Efficiency			75% min
Overvoltage protection on V1			For voltages greater than 6.2V +/- 0.4V
Short circuit protection on all DC outputs.			Maximum short circuit currents (V1) 6A (V2) 3A (V3) 3A (V4) 2A
Overcurrent protection.			
Max power on all DC outputs			95W

Detailed Description and Servicing
Power Supply

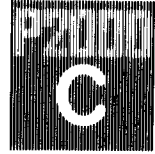

3 SAFETY PRECAUTIONS

3.1 Mains Input Plug

Mains input filters are included in the primary circuit of the power supply unit to reduce, for example, the chances of mains spikes being fed into the P2000C and producing unwanted results. Due to these filters, the removal of the mains plug while the machine is still switched on results in a high voltage being across the pins of the input plug for some time.

WARNING

ALWAYS SWITCH OFF BEFORE REMOVING THE MAINS PLUG

3.2 High Voltage Warning

HIGH VOLTAGE WARNING

VOLTAGES OF UP TO 800V ARE PRESENT IN THIS UNIT

The P2000C must not be operated with the cover removed.

Dangerous voltages of up to 800 VOLTS are present in the vicinity of the power transistor, including
THE POWER TRANSISTOR HEAT SINK.

Dangerous voltages in excess of 42V are present at various points of the power supply unit.

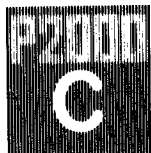

Detailed Description and Servicing
Power Supply

4

INPUT VOLTAGE SELECTION**WARNING**

No attempt must be made to carry out this procedure with power applied to the equipment. Remove the power cable first.

The power supply unit is designed to operate at either:

- 90V - 140V 47 - 66Hz (nominal 115V)
- 180V - 264V 47 - 66Hz (nominal 230V)

The unit will be set to the correct input for local conditions but should it be necessary to change the input voltage the following procedure should be carried out:

- Remove the power supply unit as described in Part 4.
- Identify the flying lead that will be connected to one of the two input pins marked:
 - 115V
 - or
 - 230V
- Ensure that the flying lead is connected to the input pin appropriate to local conditions
- Refit the power supply unit as described in Part 4

Detailed Description and Servicing
Power Supply

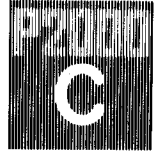

THIS PAGE INTENTIONALLY BLANK



Detailed Description and Servicing
Mainboard - Introduction

1

GENERAL

The P2000C Mainboard contains the following main functional blocks:

- 4 MHz Z80-A CPU
- Direct Memory Access
- DATA and ADDRESS Buffers
- Clock Generator
- I/O Decoder
- Memory Manager
- 64 Kb Dynamic RAM's
- Initial Program Load (IPL) ROM
- Shugart Associates Standard Interface (SASI)
- FD-Controller for 5" flexible disks
- CTC Baudrate Generator
- 3 Full Duplex Serial Channels (synchronous or asynchronous)
- Bus connector for a possible system extension

Detailed Description and Servicing
Mainboard - Introduction

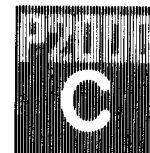

2 SIGNALS

2.1 External Signals

Pin designation of the main bus (connector PB) is shown in table 2.17 (Bus Extension). Other external connections to the Mainboard are shown in the following tables (2.1 to 2.9).

Table 2.1 SASI Connections (PSA)

PIN	SIGNAL	PIN	SIGNAL	PIN	SIGNAL
02	D00	14	D06	42	MSG-N
04	D01	16	D07	44	SEL-N
06	D02	36	BSY-N	46	C-N/D
08	D03	38	ACK-N	48	REQ-N
10	D04	40	RES-N	50	I/O
12	D05				

PINS 1, 3, 5...49, 18, 20, 22...34 - GND

Table 2.2 5½" FDC Connections (PFD)

PIN	SIGNAL	PIN	SIGNAL	PIN	SIGNAL
02	SPARE	14	DS3	26	TRKO
04	HEAD LOAD/IN USE	16	MOTON	28	WRT.PR.
06	DS4	18	DIRECTION	30	RDD
08	INDEX	20	STEP	32	SIDE SELECT
10	DS1	22	WRITE DATA	34	READY
12	DS2	24	WRT.GT.		

PINS 1, 3, 5...33, - GND

Table 2.3 External Terminal Connections (PSE 1)

PIN	SIGNAL	PIN	SIGNAL	PIN	SIGNAL
02	TxD	05	CTS	15	ASYN 0
03	RxD	06	DSR	20	DTR
04	RTS	07	GND		

Other pins - Not Connected



Detailed Description and Servicing
Mainboard - Introduction

Table 2.4 Communications Connections (PSE 2)

PIN	SIGNAL	PIN	SIGNAL	PIN	SIGNAL
02	TxD	06	DSR	17	ECLK 2
03	RxD	07	GND	20	DTR
04	RTS	08	DCD	24	ECLK 0
05	CTS	15	ECLK 1	25	ECLK 3

Other pins - Not Connected

Table 2.5 Printer Connections (PSE 3)

PIN	SIGNAL	PIN	SIGNAL	PIN	SIGNAL
02	TxD	05	CTS	07	GND
03	RxD	06	DSR	20	DTR
04	RTS				

Other pins - Not Connected

Table 2.6 Internal Serial Interface Connections (PSE 0)

PIN	SIGNAL	PIN	SIGNAL	PIN	SIGNAL
01	TxD-N	03	CTS-N	05	ASYN 0
02	RxD-N	04	RTS-N	06	GND

Table 2.7 RESET Connections (PR)

PIN	SIGNAL	PIN	SIGNAL	PIN	SIGNAL
01	SRES-N	03	GND	04	NMI-N
02	SRES-N				

Table 2.8 Power Supply Connections (P1)

PIN	SIGNAL	PIN	SIGNAL	PIN	SIGNAL	PIN	SIGNAL
01	GND	03	+5 V	05	+12 V	07	-12 V
02	GND	04	+5 V	06	+12 V	08	-12 V

Table 2.9 Optional Sound Source Connection (PC)

PIN	SIGNAL	PIN	SIGNAL	PIN	SIGNAL
01	+ 5V	02	GND	03	CTC 2 TCO 0/P

Detailed Description and Servicing
Mainboard - Introduction

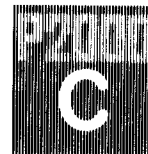

2.2 Mainboard Bus Signals

Signals are carried on a series of busses between different elements of the Mainboard, the Terminalboard, and the Extension connector. The busses to be found on the Mainboard are as follows:

<u>BUS NAME</u>	<u>SIGNALS</u>
IO D-BUS	IOD0 - IOD7
DATA BUS	IDO - ID17
ASYN BUS	ASYNO - ASYN3
AD BUS	ABO - AB15
MEM AD BUS	MAO - MA7
CS BUS	Chip Select Signals
CNTR BUS	Control Signals

The Chip Select signals are detailed in table 2.10.
The Control signals are detailed in table 2.11.

Table 2.10 P2000C Mainboard - Chip Select Signals

<u>SIGNAL</u>	<u>SELECTS</u>
CS0-N	DRQ1
CS2-N	USART
CS3-N	SASI
CS4-N	SASI
CS5-N	FD Controller
CS8-N	CTC1
CS9-N	CTC2
CSA-N	SIO
CSMM-N	Memory Manager
CSFD-N	Output Port
CSDMA-N	Direct Memory Access



Detailed Description and Servicing
Mainboard - Introduction

Table 2.11 P2000C Mainboard - Control Bus Signals

SIGNAL	DESCRIPTION
MIB-N	Machine Cycle 1-Buffered (inverted)
S1	DMA/CPU
S2	DMA/CPU - Slave/Master
Φ (Clock)	System Clock
615.38 KHz	Timing Signal
1 MHz	Timing Signal
2 MHz	Timing Signal
2 MHz B	Timing Signal
4 MHz	Timing Signal
8 MHz B	Timing Signal
BUSAK-N	Bus Acknowledge (inverted)
BUSRQ-N	Bus Request (inverted)
BAO-N	Bus Acknowledge Out (inverted)
INT-N	Interrupt (inverted)
WAIT-N	Wait (inverted)
NMI-N	Non Maskable Interrupt (inverted)
RES	Reset
RES-N	Reset (inverted)
IORQB-N	I/O Request (inverted)
IORDB-N	I/O Read (inverted)
IOWRB-N	I/O Write (inverted)
RDB-N	Read (inverted)
WRB-N	Write (inverted)
MRQB-N	Memory Request (inverted)
RFSHB-N	Refresh (inverted)
HALTB-N	Halt (inverted)
HLDA	Hold Acknowledge
TC	Terminal Count
DRQ0	Data Request 0
DRQ1	Data Request 1
DRQ2	Data Request 2
DRQ3	Data Request 3
DACK0-N	Data Acknowledge 0 (inverted)
DACK1-N	Data Acknowledge 1 (inverted)
DACK2-N	Data Acknowledge 2 (inverted)
DACK3-N	Data Acknowledge 3 (inverted)
IEIS	Interrupt Enable CTC 1
AEN	Address Enable
IEO	Interrupt Enable Out
EXTEN-N	Extension (Memory) (inverted)
EXDIS-N	Disable Internal ROM (inverted)
EINT	External Interrupt
EINT-N	External Interrupt (inverted)

Detailed Description and Servicing
Mainboard - Introduction



THIS PAGE INTENTIONALLY BLANK

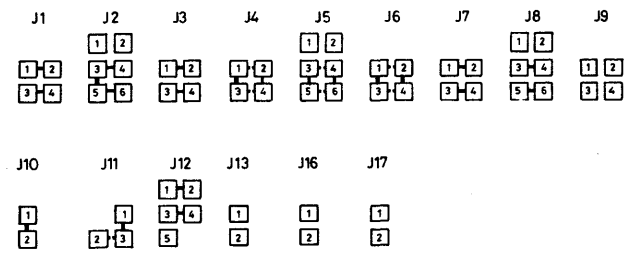
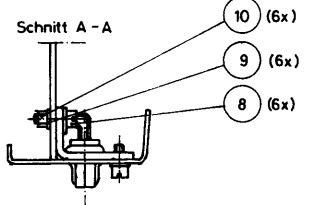
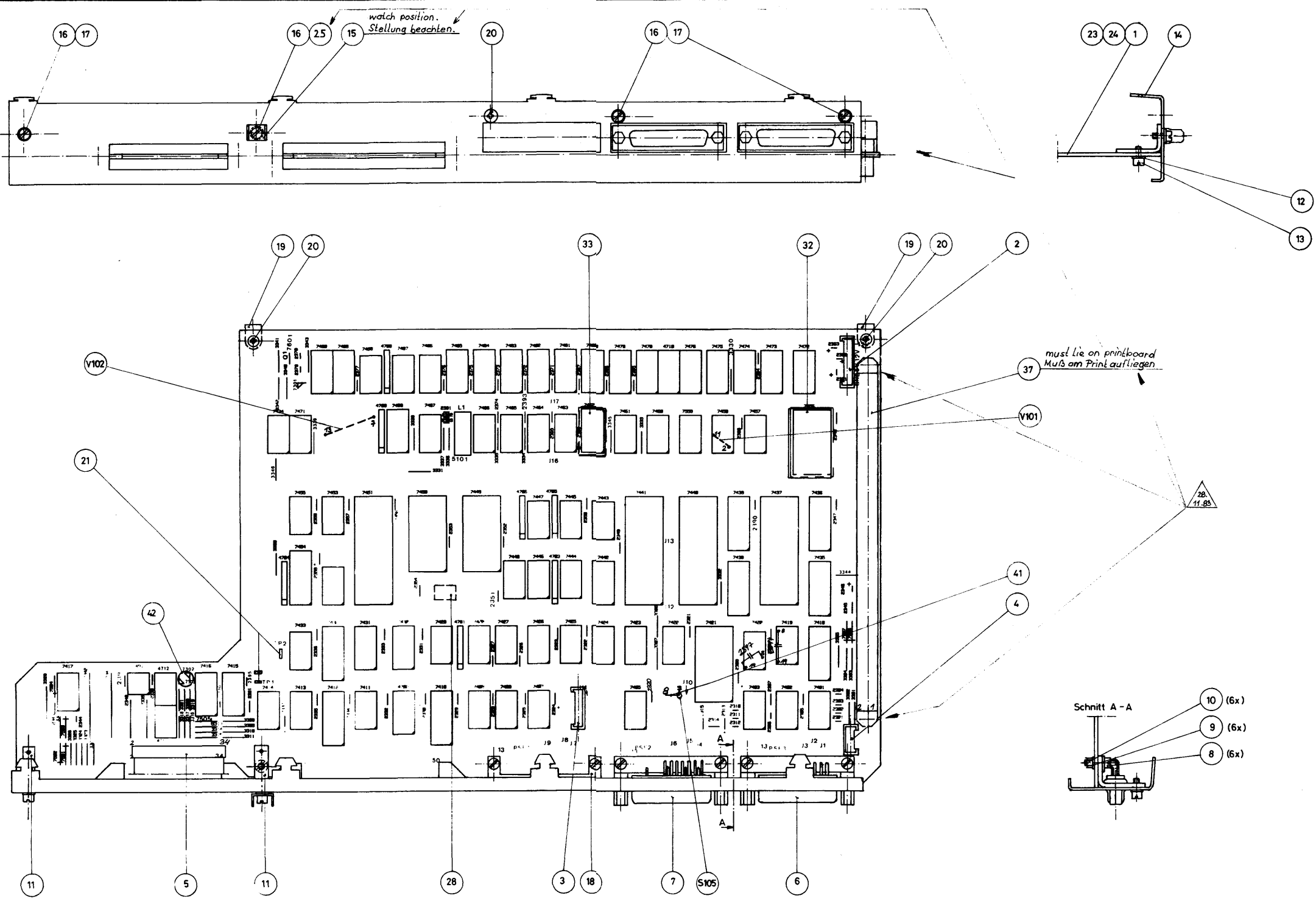

	Überstunkte x-x zuleiten	Überstunkte x-x durchtrennen
J1		
J2	3-5	
J3		
J4	1-3, 2-4	1-2, 3-4
J5	3-5, 4-6	3-4, 5-6
J6	1-3, 2-4	1-2, 3-4
J7		
J8		
J9		
J10		
J11		2-3
J12		
J13		
J14		
J15		
J16		
J17		

für Transportverpackung siehe 5103 106 6090.0!

UN - 0 08	TOLERANCES UNLESS OTHERWISE STATED BASED ON THE FOLLOWING TABLE	UN - 0 08	1 5103 106 0271 01
GENERAL: 0.1mm (0.004")	UNIT DIMENSION	ANGLE	DATE
ROUNDEDNESS: 0.1mm (0.004")	mm	MINIMUM	
ALL DIMENSIONS: 0.1mm (0.004")			
SCALE: 1:1	PROJ. SYMBOL		
CLASS NO.	printed board,assy		
7706 83	Printpl. Zus. (Mainboard)	5103 106 0271	
NAME: RENDL			
DATE: 14.06.83			

1
2
3
4
5
6
7
8
9
10
11
12
13
14
15
16
17
18
19
20
21
22
23
24
25
26
27
28
29
30
31
32
33
34
35
36
37
38
39
40
41
42
43
44
45
46
47
48
49
50
51
52
53
54
55
56
57
58
59
60
61
62
63
64
65
66
67
68
69
70
71
72
73
74
75
76
77
78
79
80
81
82
83
84
85
86
87
88
89
90
91
92
93
94
95
96
97
98
99
100
101
102
103
104
105
106
107
108
109
110
111
112
113
114
115
116
117
118
119
120
121
122
123
124
125
126
127
128
129
130
131
132
133
134
135
136
137
138
139
140
141
142
143
144
145
146
147
148
149
150
151
152
153
154
155
156
157
158
159
160
161
162
163
164
165
166
167
168
169
170
171
172
173
174
175
176
177
178
179
180
181
182
183
184
185
186
187
188
189
190
191
192
193
194
195
196
197
198
199
200
201
202
203
204
205
206
207
208
209
210
211
212
213
214
215
216
217
218
219
220
221
222
223
224
225
226
227
228
229
230
231
232
233
234
235
236
237
238
239
240
241
242
243
244
245
246
247
248
249
250
251
252
253
254
255
256
257
258
259
260
261
262
263
264
265
266
267
268
269
270
271
272
273
274
275
276
277
278
279
280
281
282
283
284
285
286
287
288
289
290
291
292
293
294
295
296
297
298
299
300
301
302
303
304
305
306
307
308
309
310
311
312
313
314
315
316
317
318
319
320
321
322
323
324
325
326
327
328
329
330
331
332
333
334
335
336
337
338
339
340
341
342
343
344
345
346
347
348
349
350
351
352
353
354
355
356
357
358
359
360
361
362
363
364
365
366
367
368
369
370
371
372
373
374
375
376
377
378
379
380
381
382
383
384
385
386
387
388
389
390
391
392
393
394
395
396
397
398
399
400
401
402
403
404
405
406
407
408
409
410
411
412
413
414
415
416
417
418
419
420
421
422
423
424
425
426
427
428
429
430
431
432
433
434
435
436
437
438
439
440
441
442
443
444
445
446
447
448
449
450
451
452
453
454
455
456
457
458
459
460
461
462
463
464
465
466
467
468
469
470
471
472
473
474
475
476
477
478
479
480
481
482
483
484
485
486
487
488
489
490
491
492
493
494
495
496
497
498
499
500
501
502
503
504
505
506
507
508
509
510
511
512
513
514
515
516
517
518
519
520
521
522
523
524
525
526
527
528
529
530
531
532
533
534
535
536
537
538
539
540
541
542
543
544
545
546
547
548
549
550
551
552
553
554
555
556
557
558
559
560
561
562
563
564
565
566
567
568
569
570
571
572
573
574
575
576
577
578
579
580
581
582
583
584
585
586
587
588
589
590
591
592
593
594
595
596
597
598
599
600
601
602
603
604
605
606
607
608
609
610
611
612
613
614
615
616
617
618
619
620
621
622
623
624
625
626
627
628
629
630
631
632
633
634
635
636
637
638
639
640
641
642
643
644
645
646
647
648
649
650
651
652
653
654
655
656
657
658
659
660
661
662
663
664
665
666
667
668
669
670
671
672
673
674
675
676
677
678
679
680
681
682
683
684
685
686
687
688
689
690
691
692
693
694
695
696
697
698
699
700
701
702
703
704
705
706
707
708
709
710
711
712
713
714
715
716
717
718
719
720
721
722
723
724
725
726
727
728
729
730
731
732
733
734
735
736
737
738
739
740
741
742
743
744
745
746
747
748
749
750
751
752
753
754
755
756
757
758
759
760
761
762
763
764
765
766
767
768
769
770
771
772
773
774
775
776
777
778
779
780
781
782
783
784
785
786
787
788
789
790
791
792
793
794
795
796
797
798
799
800
801
802
803
804
805
806
807
808
809
810
811
812
813
814
815
816
817
818
819
820
821
822
823
824
825
826
827
828
829
830
831
832
833
834
835
836
837
838
839
840
841
842
843
844
845
846
847
848
849
850
851
852
853
854
855
856
857
858
859
860
861
862
863
864
865
866
867
868
869
870
871
872
873
874
875
876
877
878
879
880
881
882
883
884
885
886
887
888
889
890
891
892
893
894
895
896
897
898
899
900
901
902
903
904
905
906
907
908
909
910
911
912
913
914
915
916
917
918
919
920
921
922
923
924
925
926
927
928
929
930
931
932
933
934
935
936
937
938
939
940
941
942
943
944
945
946
947
948
949
950
951
952
953
954
955
956
957
958
959
960
961
962
963
964
965
966
967
968
969
970
971
972
973
974
975
976
977
978
979
980
981
982
983
984
985
986
987
988
989
990
991
992
993
994
995
996
997
998
999
1000

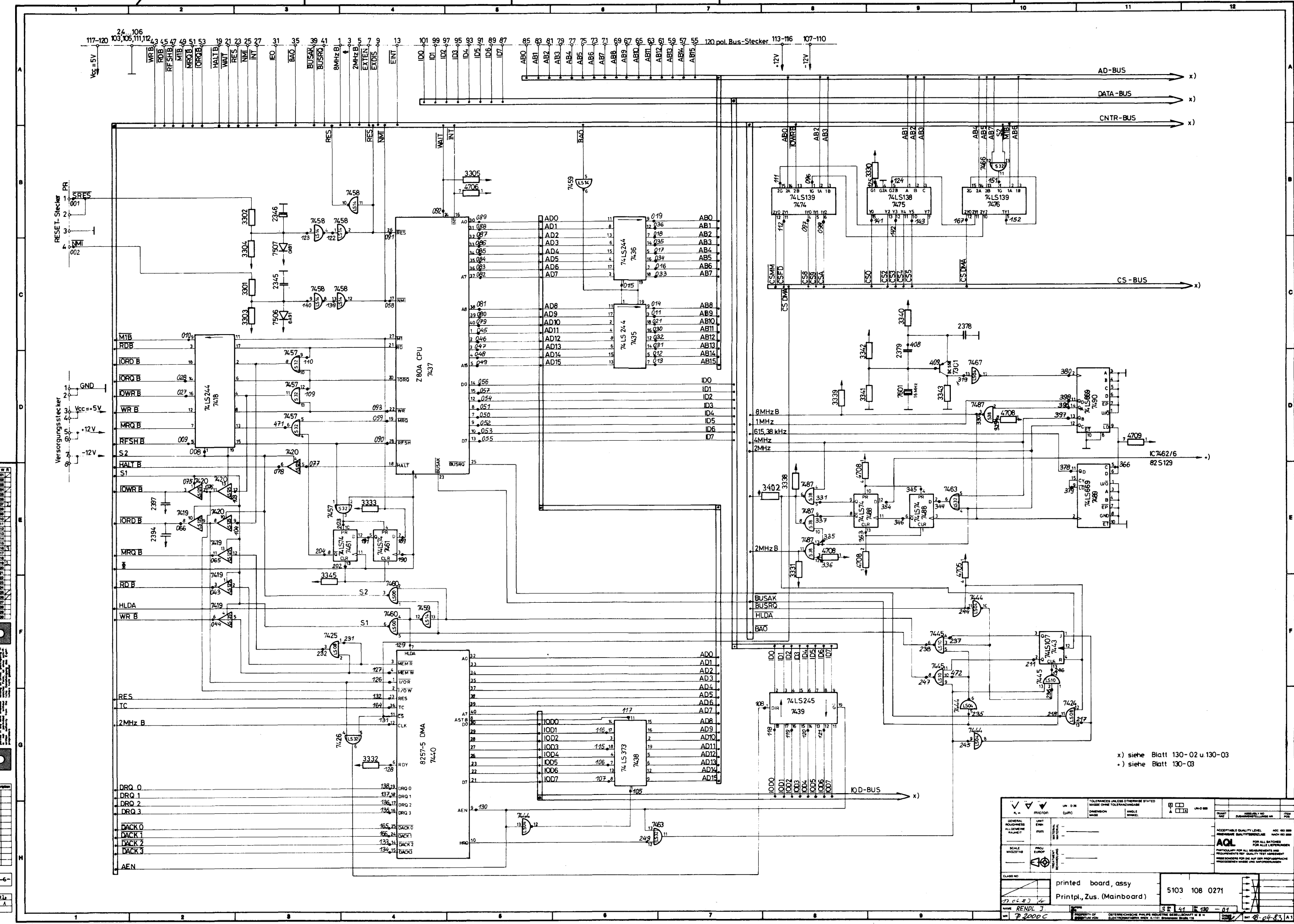

x) siehe Blatt 130-02 u.130-03
 *) siehe Blatt 130-03

GENERAL INFORMATION		DIMENSIONS		MATERIAL		FINISH	
UNIT	FRAC	UNIT	FRAC	UNIT	FRAC	UNIT	FRAC
LENGTH	MM	LENGTH	MM	MATERIAL		FINISH	
WIDTH	MM	WIDTH	MM	FINISH		FINISH	
HEIGHT	MM	HEIGHT	MM	FINISH		FINISH	
WEIGHT	G	WEIGHT	G	FINISH		FINISH	

CLASS NO.	5103 108 0271
PRINTED BOARD ASSY	
PRINTPL., ZUS. (MAINBOARD)	
DATE	27.06.87
NAME	RENDL J
PROJ.	2 2000 C

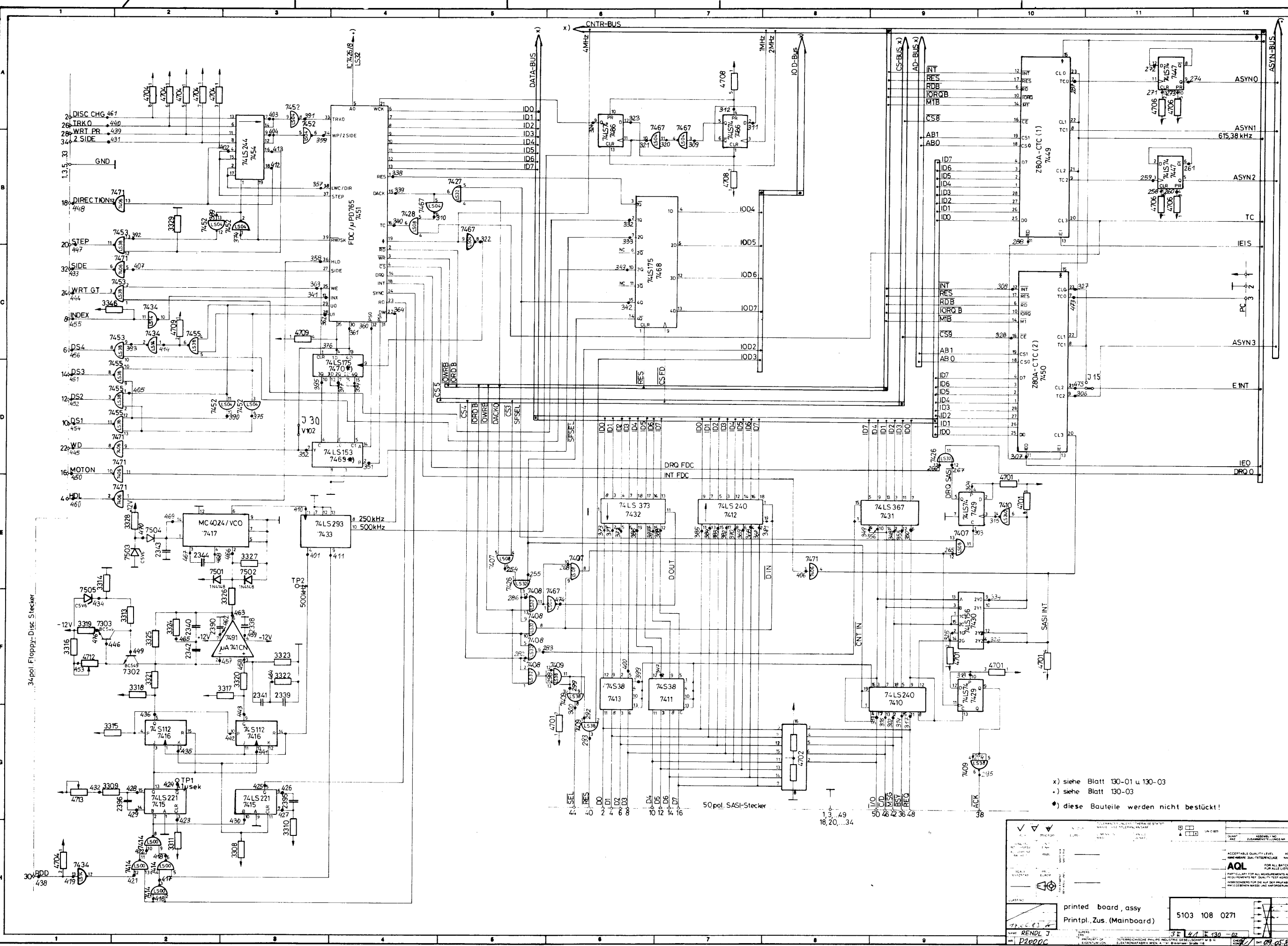

34-pol. Floppy-Disc Stecker

50-pol. SASI-Stecker

- x) siehe Blatt 130-01 u 130-03
-) siehe Blatt 130-03
- * diese Bauteile werden nicht bestückt!

<p>ACCEPTABLE QUALITY LEVEL</p> <p>FOR ALL BATCHES</p> <p>FOR ALL CATEGORIES</p> <p>FOR ALL TYPES</p> <p>FOR ALL PARTS</p> <p>FOR ALL TESTS</p> <p>FOR ALL MEASUREMENTS</p> <p>FOR ALL INSPECTIONS</p> <p>FOR ALL DELIVERIES</p> <p>FOR ALL CUSTOMERS</p> <p>FOR ALL SUPPLIERS</p> <p>FOR ALL PARTNERS</p> <p>FOR ALL COLLEAGUES</p> <p>FOR ALL FRIENDS</p> <p>FOR ALL HUMAN BEINGS</p>	<p>CLASS NO.</p> <p>PRINTED BOARD, ASSY</p> <p>Printpl. Zus. (Mainboard)</p> <p>5103 108 0271</p> <p>RENDL 7</p> <p>D2000C</p> <p>DATE: 02.05.83</p>
---	--

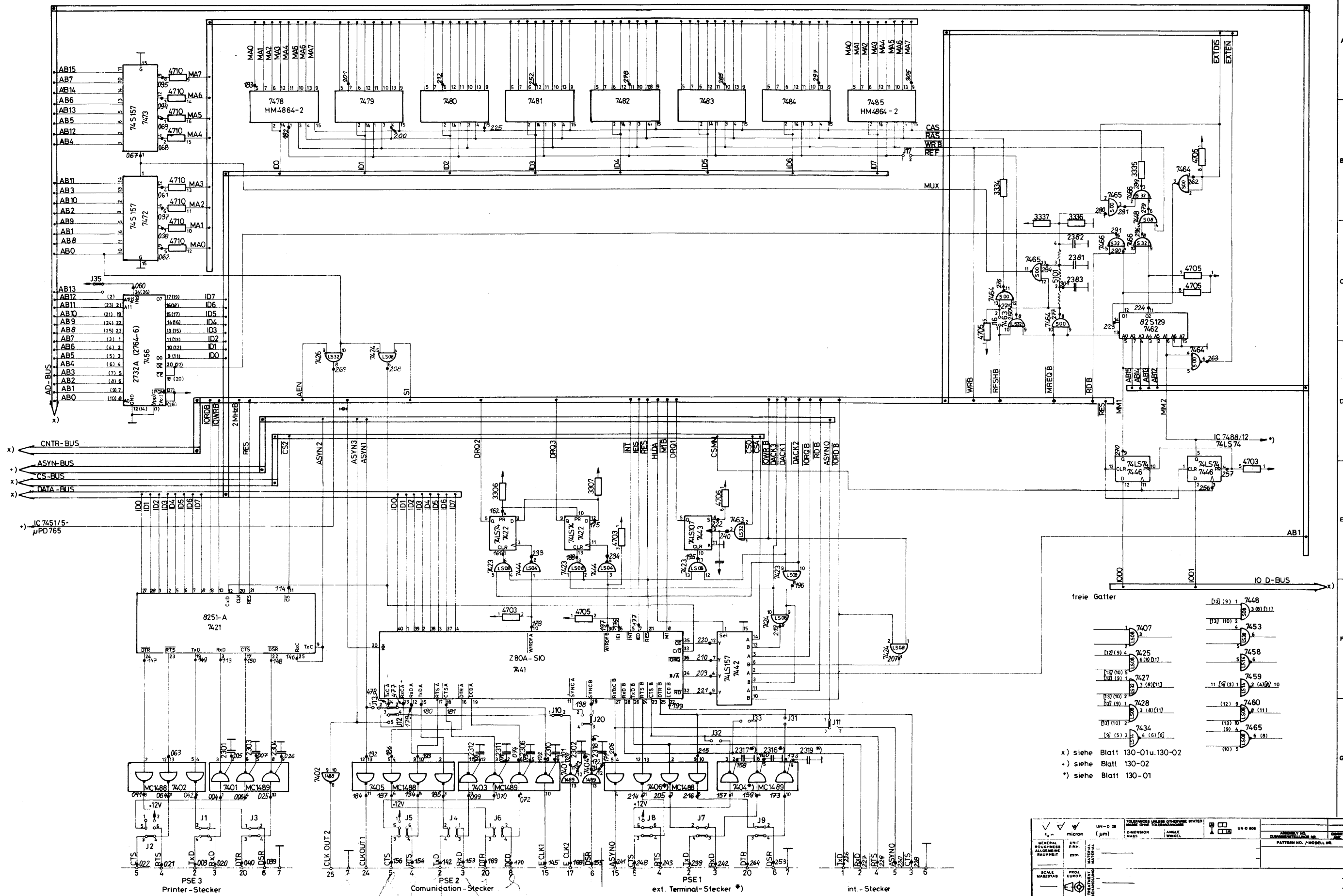

freie Gatter

(12) (9) 1	7448
(13) (10) 3	7453
(13) (10) 4	7458
(11) (10) 5	7459
(13) (10) 2	7460
(13) (10) 2	7465
(8) (5) 3	7434
(12) 9	7460
(13) 3	7465
(10) 5	7460

x) siehe Blatt 130-01u.130-02
 *) siehe Blatt 130-02
 *) siehe Blatt 130-01

Handwritten note: o/su low time spu 450 450

* diese Bauteile werden nicht bestückt

UN-D 28	TOLERANZ (UNLESS OTHERWISE STATED)	UN-D 008
GENERAL ROUGHNESS	mm	
AL-GEMEINE RAUHEIT	mm	
SCALE	PROJ. ALIQUOT	
MATERIAL	PREPARED BY	
CLASS NO.	printed board, assy	
PRINTED BOARD NO.	Printpl., Zus. (Mainboard)	5103 108 0271
NAME	RENDL J	
PROPERTY OF	PHILIPS INDUSTRIELLE GEBÄUDEFABRIK	
DATE	19.04.73	
BY	P2000C	

2002 100 00015

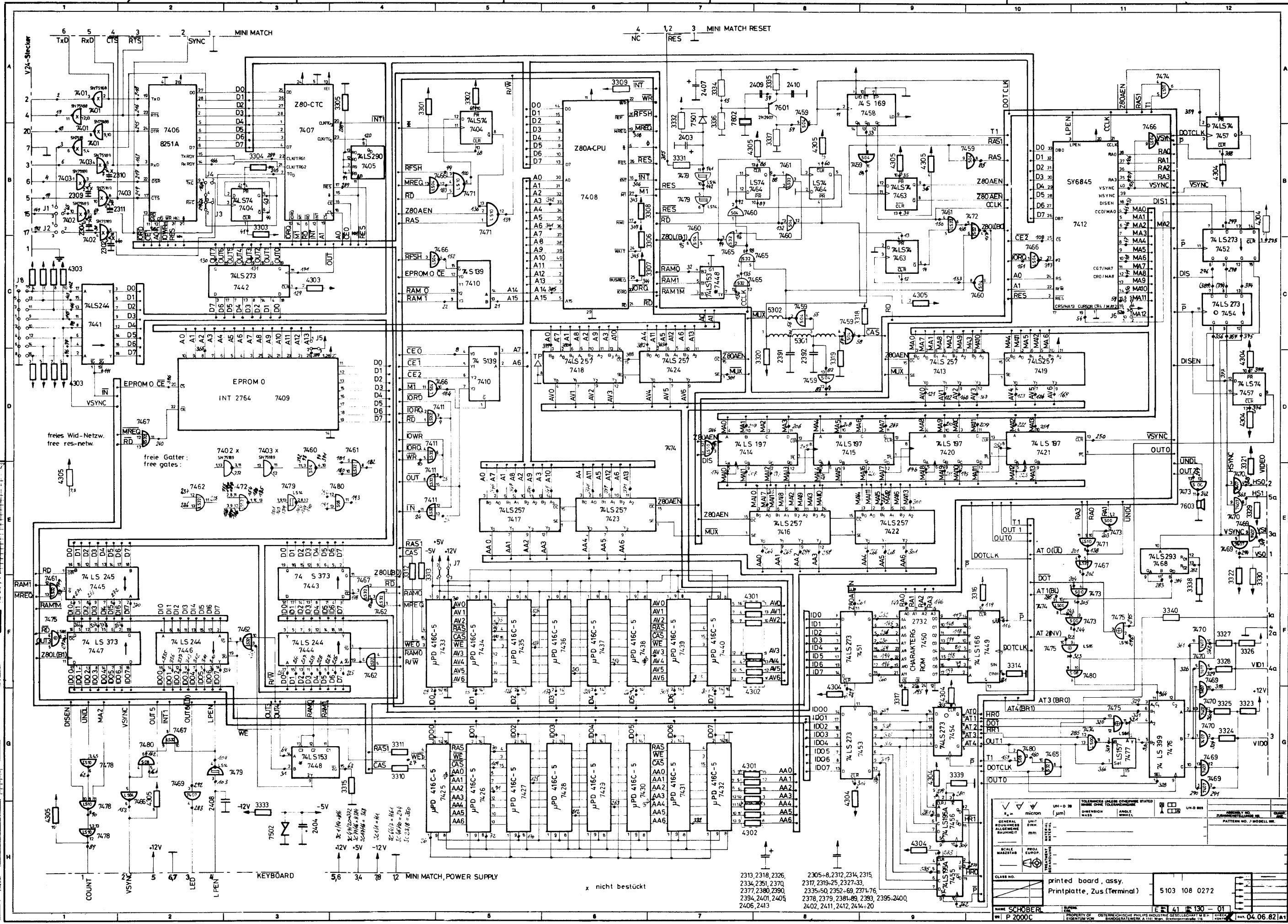

UN-0-28		UN-0-28		UN-0-28	
GENERAL	UN-0-28	UN-0-28	UN-0-28	UN-0-28	UN-0-28
GENERAL	UN-0-28	UN-0-28	UN-0-28	UN-0-28	UN-0-28
ALLGEMEIN	UN-0-28	UN-0-28	UN-0-28	UN-0-28	UN-0-28
BAUWEISE	UN-0-28	UN-0-28	UN-0-28	UN-0-28	UN-0-28
SCALE	UN-0-28	UN-0-28	UN-0-28	UN-0-28	UN-0-28
PROJ. EQUIP.	UN-0-28	UN-0-28	UN-0-28	UN-0-28	UN-0-28
CLASS NO.	UN-0-28	UN-0-28	UN-0-28	UN-0-28	UN-0-28
PRINTED BOARD, ASSY.	UN-0-28	UN-0-28	UN-0-28	UN-0-28	UN-0-28
Printplatte, assy. (Terminal)	UN-0-28	UN-0-28	UN-0-28	UN-0-28	UN-0-28
5103 108 0272	UN-0-28	UN-0-28	UN-0-28	UN-0-28	UN-0-28
NAME SCHÖBER	UN-0-28	UN-0-28	UN-0-28	UN-0-28	UN-0-28
PROPERTY OF PHILIPS INDUSTRIE GESELLSCHAFT M.B.H.	UN-0-28	UN-0-28	UN-0-28	UN-0-28	UN-0-28
DATE 04.06.82	UN-0-28	UN-0-28	UN-0-28	UN-0-28	UN-0-28

COUNT VSYNC LED LPEN KEYBOARD

x nicht bestückt

2313, 2318, 2326, 2334, 2351, 2370, 2377, 2380, 2390, 2394, 2401, 2405, 2406, 2413
 2305-8, 2312, 2314, 2315, 2317, 2319-25, 2327-33, 2335-50, 2352-69, 2371-76, 2378, 2379, 2381-89, 2393, 2395-2400, 2402, 2411, 2412, 2414, 2415

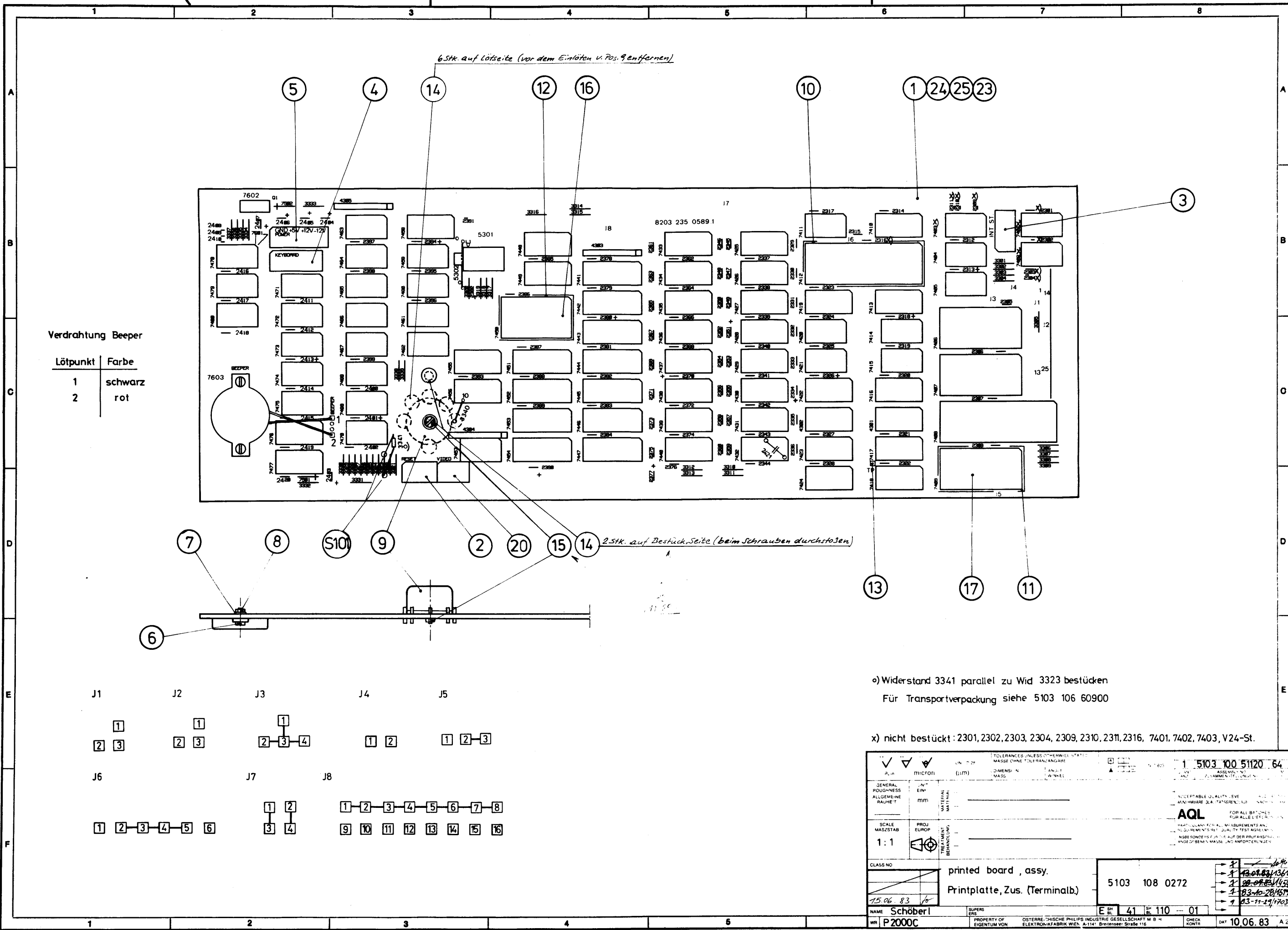

6 Stk. auf Lötlseite (vor dem Einlöten v. Pos. 9 entfernen)

2 Stk. auf Bestück-Seite (beim Schrauben durchstoßen)

Verdrahtung Beeper

Lötpunkt	Farbe
1	schwarz
2	rot

W	R
01	
02	
03	
04	
05	
06	
07	
08	
09	
10	
11	
12	
13	
14	
15	
16	
17	
18	
19	
20	
21	
22	
23	
24	
25	
26	
27	
28	
29	
30	

All rights strictly reserved. Reproduction or reuse to third parties without the written permission of the manufacturer is not permitted. The manufacturer is not responsible for any damage or loss of data resulting from the use of this product.

Subscription

1
2
3
4
5
6
7
8
9
10
11
12
13
14
15
16
17
18
19
20
21
22
23
24
25
26
27
28
29
30

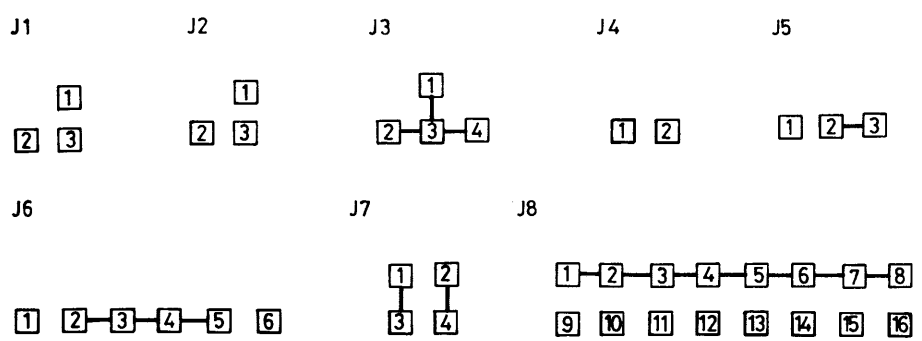

o) Widerstand 3341 parallel zu Wid 3323 bestücken
Für Transportverpackung siehe 5103 106 60900

x) nicht bestückt: 2301, 2302, 2303, 2304, 2309, 2310, 2311, 2316, 7401, 7402, 7403, V24-St.

<input checked="" type="checkbox"/> A, in micron (µm) <input checked="" type="checkbox"/> B, in micron (µm) <input checked="" type="checkbox"/> C, in micron (µm)		TOLERANCES UNLESS OTHERWISE STATED MASSE OHNE TOLERANZANGABE DIMENSIONEN IN MILLIMETERN MASSEN IN GRAMMEN		1 5103 100 51120 64
GENERAL ROUGHNESS ALLGEMEINE RAUHEIT	SURFACE FINISH OBERFLÄCHENBEHANDLUNG	MATERIAL	ACCEPTABLE QUALITY LEVEL ANNAHMEBARE QUALITÄTSGRENZE	AQL
SCALE MASZSTAB	PROJ. EUROPEAN BEHANDLUNG	MATERIAL	FOR ALL BATCHES FÜR ALLE LIEFERUNGEN	PARTIALLY FOR ALL MEASUREMENTS AND REQUIREMENTS TEILWEISE FÜR ALLE MASSNACHWEISEN UND ANFORDERUNGEN
CLASS NO.	printed board, assy. Printplatte, Zus. (Terminalb.)	5103 108 0272	15.06.83	13-09-83/1361 20-09-83/1154 1-83-10-28/1574 7-83-11-29/1703
NAME Schöberl	PROPERTY OF EIGENTUM VON	OSTERREICHISCHE PHILIPS INDUSTRIE GESELLSCHAFT M.B.H. ELEKTRONIKFABRIK WIEN, A-1141 Brientener Straße 116	E SH 41 SH 110 -- 01	DATE 10.06.83



Detailed Description and Servicing
Mainboard - CPU

1

GENERAL

The Z80A CPU, a third generation single-chip microprocessor with exceptional computational power, offers higher system throughput and more efficient memory utilization than comparable second and third generation microprocessors. The internal registers contain 208 bits of read/write memory accessible to the programmer, including 2 sets of 6 general purpose registers which may be used individually as 8 bit registers or as 16 bit register pairs, and 2 sets of accumulator and flag registers. An 'exchange' instruction set makes either set of main or alternate registers accessible to the programmer. The alternate set allows operation in foreground-background mode or may be reserved for very fast interrupt response. The Z80A contains Stack Pointer, Program Counter, 2 Index Registers, a Refresh Register (counter), and an Interrupt Register. Output signals are fully decoded and timed to control standard memory or peripheral circuits. The Z80A is supported by an extensive family of peripheral controllers. Figure 2.1 shows the main functions. Full details of the Z80A CPU can be found in the Z80A Mostek 1979 Microcomputer Components Data Sheets

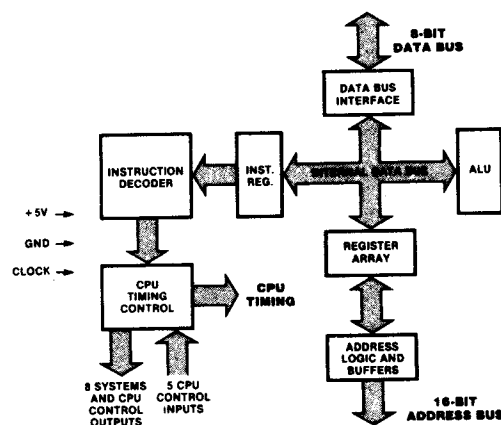
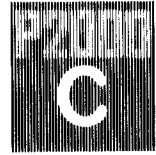

Figure 2.1 Z80A CPU - Block Diagram

In the P2000C, the Z80A CPU operates at a frequency of 4 MHz when working with RAM, and is switched to 2 MHz when working with additional ROM. (See also Chapter 2.4 - Clock Generator).

Detailed Description and Servicing
Mainboard - CPU



2

BLOCK DIAGRAM

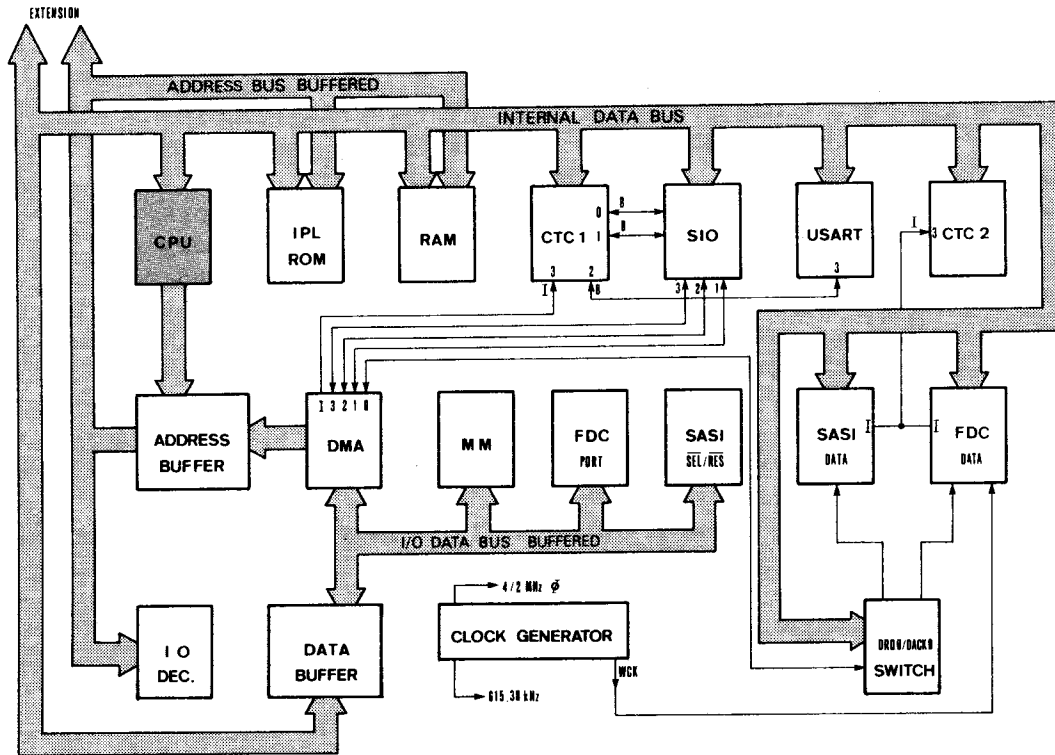
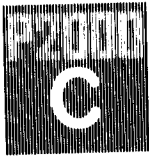

Figure 2.2 P2000C - CPU Block Diagram



Detailed Description and Servicing
Mainboard - CPU

3

CIRCUIT DESCRIPTIONS

3.1

Data Bus and Address Bus

As shown in figure 2.2, the system data bus is partly buffered. Although the CPU (item 7437) is able to drive four LS TTL loads, this buffering ensures that a maximum of three loads are on the data bus at any time. The Address bus is fully buffered. The CPU address bus and the DMA address lines are simultaneously buffered by the same two I.C. drivers 74 LS 244 (items 7435/7436).

3.2

Control Bus

Two components on the Mainboard (DMA and USART) require special compound signals, which are produced by items 7457, 7419 and 7420 as follows:

IORD-N signal formed from the RD-N & IORQ-N signals.
IOWR-N signal formed from the WR-N & IORQ-N signals.

In order to prevent any possibility of timing problems between a RAM access and a Refresh, the MREQ-N signal is "precharged" using a circuit consisting of two D-FF's (Item 7461).
RAS Precharge Time - worst case = 60 ns.

Precharge logic timing is shown with the DMA/CPU Timing Diagram on page 3.2 3-6.

Note : This circuit only functions during an Opcode fetch (activated by M1-N). Correct function is only guaranteed if no wait states are used. In memory write or read and I/O cycles, this circuit remains idle.

The Control Bus signals are fully buffered.

For situation of CPU in relation to other Mainboard circuits, please refer to the full circuit diagrams.

Detailed Description and Servicing
Mainboard - CPU



3.3 Additional Signals

The signals RES-N and NMI-N can be activated by external debounced switches. Only the RESET switch is implemented. At each power-up the RES-N signal is automatically activated. The signal NMI-N is also activated during the power up phase but is of shorter duration (due to the use of a smaller CR time constant) than the RESET and does not affect the CPU operation.

The DMA is programmed by, and works under the control of, the CPU. A handshake routine, in the form of a simple data exchange, is used to allocate use of the data bus to the DMA as required and to ensure that only one device attempts to use the bus at any time. BUSAK-N controls the tristate outputs of the Bus buffer, offering a high impedance to the bus. BUSAK-N and BUSRQ-N work with the 8257 DMA. Both of these signals are available on the Bus plug.

The priority logic ensures that internal DMA (bus request HRQ) has priority over additional, external DMA on the bus extension (bus request BRE), in the event of contention. However, once either internal or external DMA has initiated a transfer, no interruption is allowed.

The Z80A can be used in three interrupt modes - 0, 1 and 2. The P2000C uses Interrupt mode 2, which is supported by two CTCs (used as Interrupt controllers) and the SIO. If the basic unit is extended, via the 120 way Bus plug, only one additional Z80 Interrupt device is allowed. This is because a maximum of four devices are allowed with the 4 MHz configuration due to delay times in the interrupt daisy chain. Further details of the Z80A Interrupt Modes are given in the CPU Data Sheet.

The Wait line is not used on the Mainboard, and must not be used on the optional extension board in combination with an Opcode fetch cycle. It can be used on the extension board to slow down I/O transfers when working with slower devices.



Detailed Description and Servicing
Mainboard - DMA

1

GENERAL

The Intel 8257 is a 4-channel direct memory access (DMA) controller. It is specifically designed to simplify the transfer of data at high speeds. Its primary function is to generate, upon a peripheral request, a sequential memory address which will allow the peripheral to read or write data directly to or from memory. Acquisition of the system bus is accomplished via the CPU's hold function. The 8257 has priority logic that resolves the peripherals requests and issues a composite hold request to the CPU. It maintains the DMA cycle count for each channel and outputs a control signal to notify the CPU that the programmed number of DMA cycles is complete. Other output control signals simplify sector data transfers. The 8257 greatly simplifies the transfer of data at high speed between peripherals and memories.

Full details of the Intel 8257 DMA can be found in the Intel Component Data Catalogue 1981.

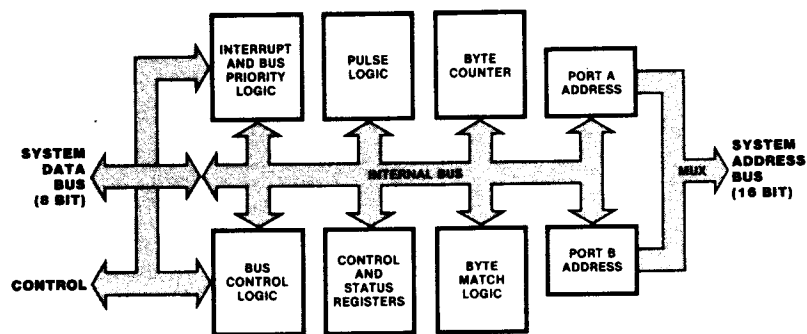
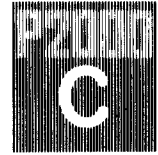

Figure 2.3 8257 DMA - Block Diagram

Detailed Description and Servicing
Mainboard - DMA



In the P2000C, the 8257 DMA Controller operates at a frequency of 2 MHz. It controls transfers from Memory to I/O and I/O to Memory in four channels (0 to 3).

The DMA operates in either Master or Slave mode. In the Slave mode the CPU has full control of the Address, Data and Control bus, and prepares the DMA for later transfers of data. Once control has been handed to the DMA, switching it to Master mode, it controls the transfer of data directly between the I/O device and memory by the use of DACK-N signals.

2

BLOCK DIAGRAM

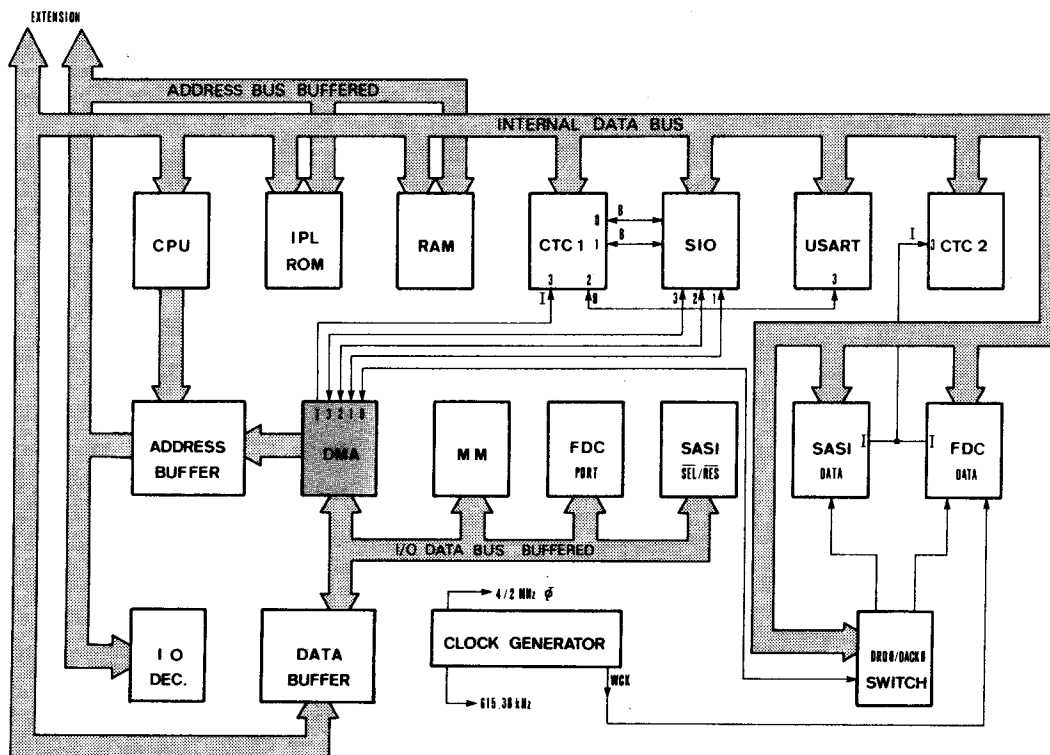

Figure 2.4 P2000C - DMA Block Diagram



Detailed Description and Servicing
Mainboard - DMA

3 CIRCUIT DESCRIPTIONS

3.1 Data Transfer

The DMA Controller (item 7440) only generates the addresses and control signals required to transfer the data between memory and the I/O. No intermediate storage is involved and the data is not routed through the controller. For this reason the DMA Chip can operate on the I/O Data bus while the addressed I/O devices are operating on the internal Data bus.

Each channel has a DRQ input from the I/O Device and a DACK-N output to the I/O Device. Channel 0 has the highest priority when the Rotating Priority Mode bit is not set to zero.

Channel 0 has two possible uses. Selection can be made, via the output board 1FH bit 7 (FDC Port), between:

- FDC (bit 7 = "0") and
- SASI (bit 7 = "1")

Note: The selection has to be defined by software, to ensure that only the correct unit can demand a DMA Cycle, and the FDC must be reset before the SASI is selected.

Table 2.12 - Distribution of the DMA Channels

CHANNEL	DESTINATION	PURPOSE
0	FDC or SASI	Data Transfer
1	SIO Channel A	Communication
2	SIO Channel A	Communication
3	SIO Channel B	Terminal

The control signals of the DMA-Controller are buffered. The circuitry ensures that these buffers are correctly controlled to avoid bus conflict. This is achieved with the Priority Logic circuit which produces the HLDA-N and BAO-N from the HRQ, AEN, BUSACK-N, BUSRQ-N and system clock signals (items 7443, 7444, 7445, 7424 and 7463).

DMA address lines and the CPU address bus are simultaneously buffered by the same two I.C. drivers 74 LS 244 (items 7435/6).

Detailed Description and Servicing
Mainboard - DMA



3.2 Multiplexed Address/Data Bus

The address strobe is used to store the addresses in the transparent D-latch 74 LS 373 (item 7438), where the higher addresses are formed.

3.3 Software Considerations

The DMA always works in the Single Byte Mode. This ensures that the RAM's will be refreshed correctly. When the FDC DMA Channel is active, timing problems may be caused by using the Rotating Priority Mode.

The SIO has only one ready signal for each channel which can be used as DRQ signal for the DMA. To make it possible to drive the communications interface via DMA in both directions (receiver and transmitter), an artificial DRQ signal must be generated for one direction. This is achieved in the following way:

- The DMA chip must first be programmed (slave mode). If a data transfer has to be carried out, the SIO triggers an interrupt. Only one Out-command to address 10H or 11H is necessary (in the Interrupt Service Routine) to start the data transfer. The SIO programming defines whether this procedure is to be used for transmitting or receiving data. This is much faster than the complete treatment with software.

If transmission and reception are at different baud rates, it is advisable that the faster process should use the W/RDY pin on the SIO to start the DMA transfer. This will minimise the effect of using the above process. (See Note below).

At the terminal interface you can also select, by Software, whether the Receiver or the Transmitter shall be processed by DMA.

Note: Even if transmission and reception are at the same baud rate, the programmer should decide which direction is more time critical.

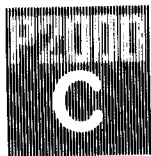

Detailed Description and Servicing
Mainboard - DMA

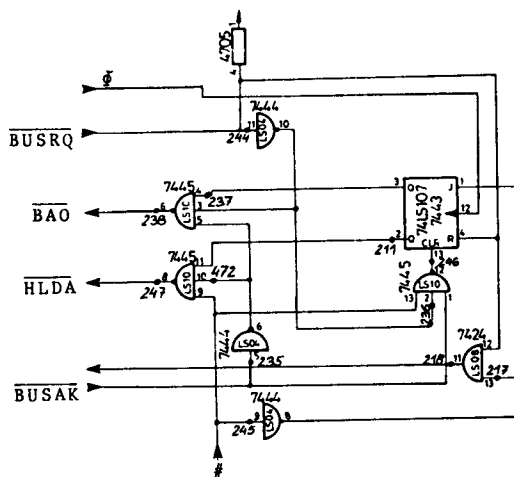
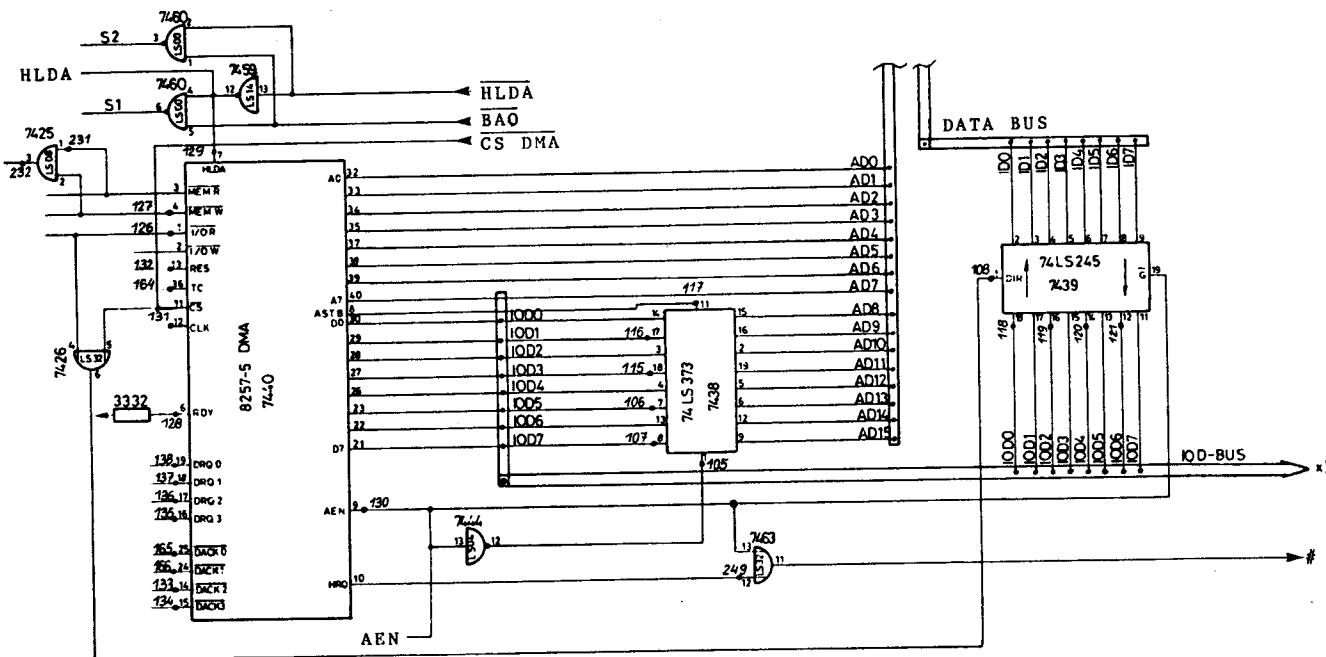
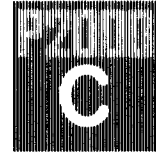
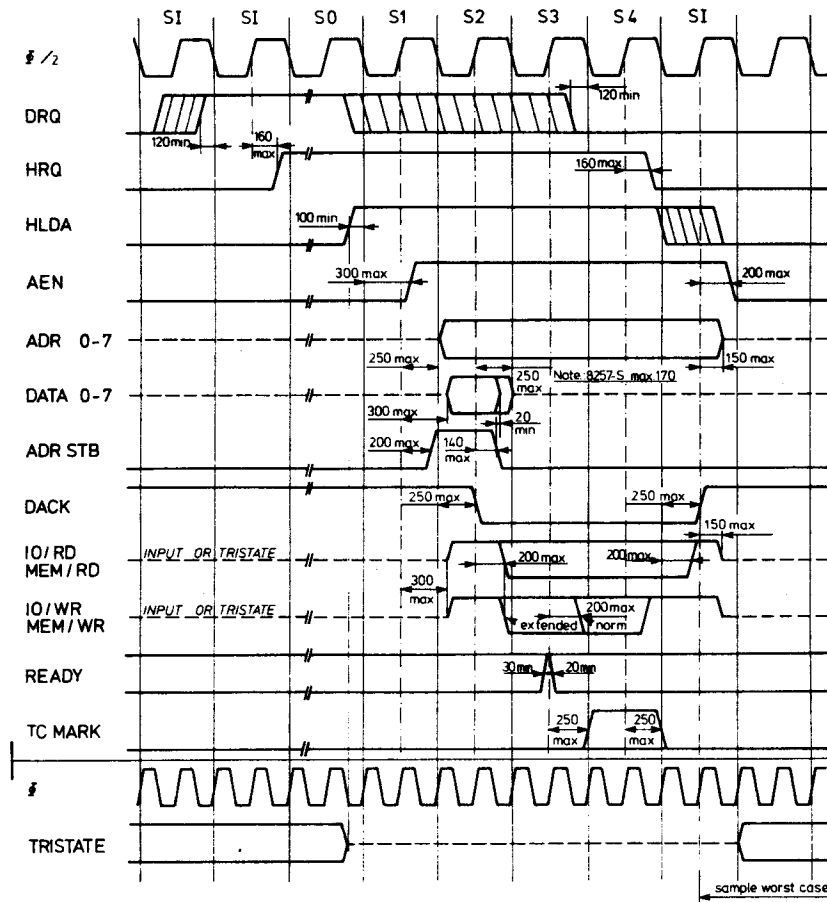

Figure 2.5 Circuit Diagram - DMA



Detailed Description and Servicing
Mainboard - DMA



DMA/CPU Timing

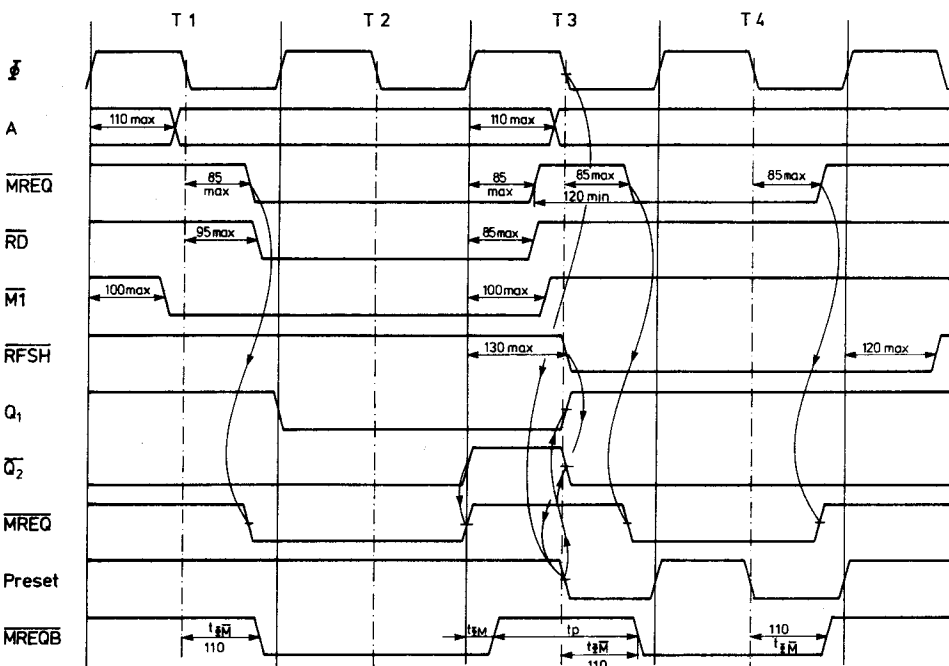

Memory Request Precharge Logic Timing



Detailed Description and Servicing
Mainboard - DATA/ADDRESS Buffers

1 GENERAL

The system data bus is partly buffered, and is capable of handling a maximum of 3 TTL LS loads. The component used for this function is a bi-directional selectable latch/buffer. The address bus is fully buffered. The CPU address bus and the DMA address lines are simultaneously buffered.

2 BLOCK DIAGRAM

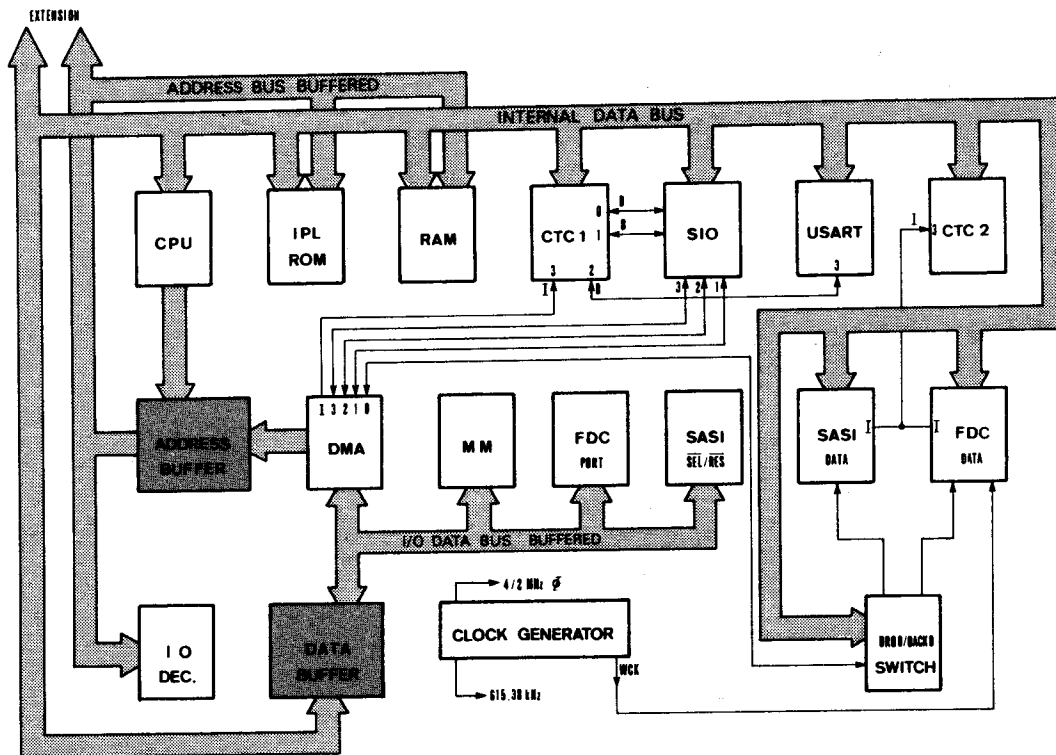
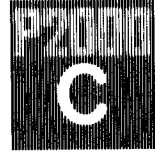

Figure 2.6 P2000C - DATA/ADDRESS Buffers Block Diagram

Detailed Description and Servicing
Mainboard - DATA/ADDRESS Buffers



3 CIRCUIT DESCRIPTION

The bi-directional latch 74 LS 245 (item 7439) is controlled by a signal which is derived, via an OR-gate (item 7426), from the DMA signals CS-N or I/OR-N. The two 74 LS 244 (items 7435/7436) are used as address bus buffers.

3.1 Internal Data Bus - Loading

The following tables show the maximum resistive and capacitive loadings for the internal data bus:

RESISTIVE LOADING

	ID0	ID1	ID2	ID3	ID4	ID5	ID6	ID7
Bus buffer	+	+	+	+	+	+	+	+
SASI data out	+	+	+	+	+	+	+	+
Optional exten	+	+	+	+	+	+	+	+
Maximum 3 LS TTL loads								

CAPACITIVE LOADING

USART + SIO	60pF
IPL ROM	12pF
RAM	7pF
CTCs at 20pF	40pF
TTL at 5pF	
SASI out (1)	5pF
SASI in (2)	10pF
Extension (1)	5pF
Buffer (1)	5pF
<u>Total capacitive load</u>	<u>144pF</u>

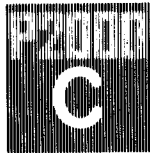

Detailed Description and Servicing
Mainboard - DATA Buffers

3.2 I/O Data Bus - Loading

The following tables show the maximum resistive and capacitive loadings for the I/O data bus:

RESISTIVE LOADING

	ID0	ID1	ID2	ID3	ID4	ID5	ID6	ID7
DMA latch	+	+	+	+	+	+	+	+
Memory manager	+	+	+	+				
FDC Out Port					+	+	+	+
SASI SEL,RES			+	+				
Maximum 3 LS TTL loads								

CAPACITIVE LOADING

DMA chip	20pF
TTL at 5pF	
DMA latch (1)	5pF
Memory manager &	
FDC Port (1)	5pF
Buffer (1)	5pF
SASI SEL,RES (1)	5pF
<hr/> Total capacitive load	40pF

Detailed Description and Servicing
Mainboard - DATA Buffers

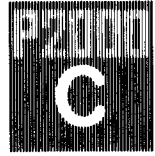

THIS PAGE INTENTIONALLY BLANK



Detailed Description and Servicing
Mainboard - Clock Generator

1 GENERAL

All frequencies which are needed on the Mainboard are produced by the Clock Generator, including some special signals:

- 16 MHz
- 8 MHz
- 4 MHz
- 2 MHz
- 1 MHz

615,38 kHz

Write clock for the FDC (WCK)

2 BLOCK DIAGRAM

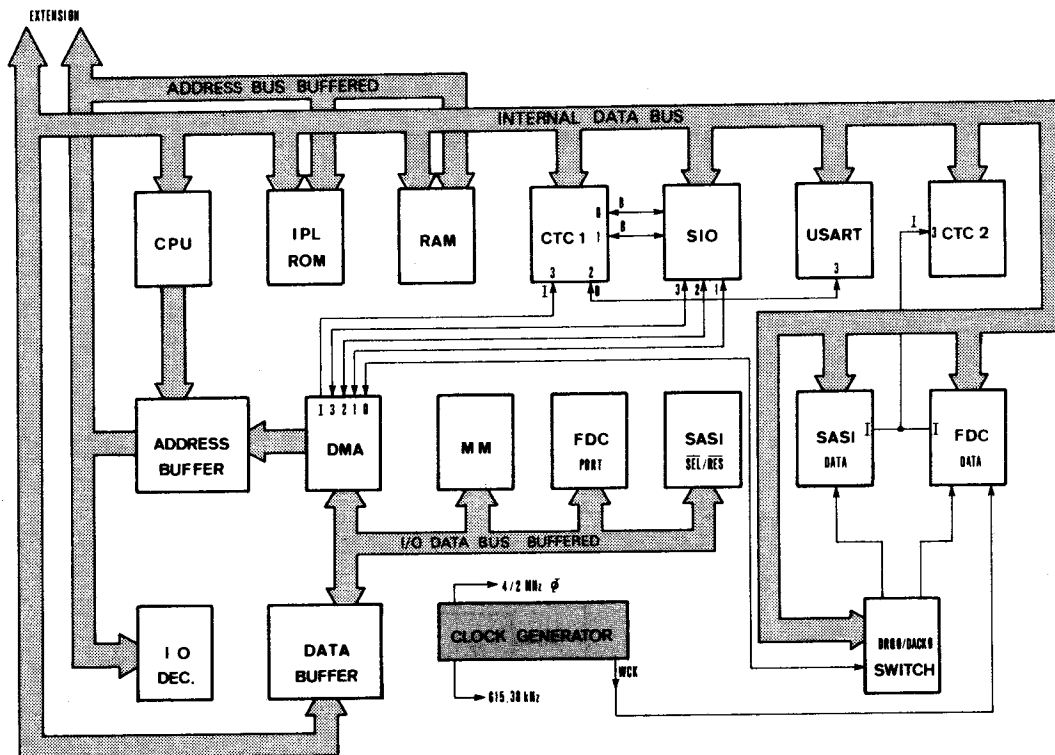
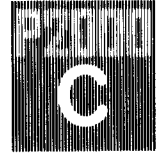

Figure 2.7 P2000C - Clock Generator Block Diagram

Detailed Description and Servicing
Mainboard - Clock Generator



3

CIRCUIT DESCRIPTION

A quartz stabilised Colpits-Oscillator generates a frequency of 16 MHz. It is followed by a TTL-buffer (item 7467) with a Schmitt-trigger input. The outputs are obtained, by division, from a 4 bit binary counter (items 7489/7490). See figure 2.10.

The 4 MHz signal is used as the system clock. Due to the use of slower ROMs, the system clock is switched over to 2 MHz when the Memory Manager accesses ROM. (MM2 = 0).

The circuit with two flip-flops (item 7488) ensures that no spikes can be produced in the clock during switch over. (Both input clocks are "0" during the switch-over, making the following Open Collector Drivers (item 7487) inactive.)
(See Timing Diagram - A)

The 8 MHz signal is used to clock a second 4 bit counter. It is wired to count down from 12 to 0 in order to create the input frequency of 615.38 kHz used for the Baud Rate Generators. (Note: $19\,200 \times 32 = 614.4$ kHz, a deviation of 0.16%).
(See Timing Diagram - B)

The 1 MHz signal is used to generate an asynchronous 500 kHz signal (2 μ s cycle-time). This signal is combined with the 2 MHz signal (250 ns one half-cycle) to produce the timing for the Floppy Disk Write Clock WCK (using item 7486). The two inverters (item 7467) are used to delay the 500 kHz signal to avoid spikes in the WCK signal. (See Timing Diagram - C)

Timing diagrams for the Mainboard Clock Generator are shown in figure 2.9.

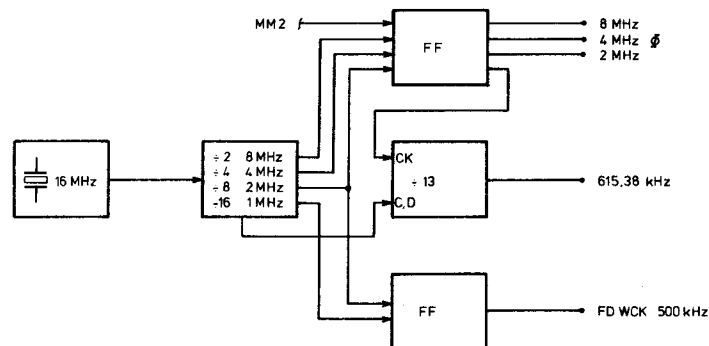
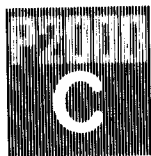
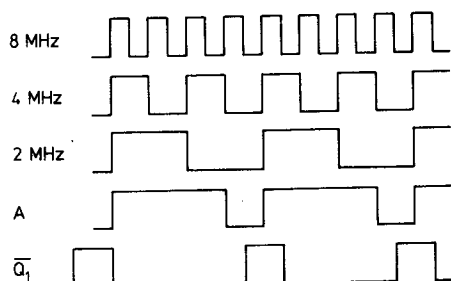

Figure 2.8 Clock Generator - Detailed Block Diagram



Detailed Description and Servicing
Mainboard - Clock Generator

A - System Clock



B - Baudrate Generation

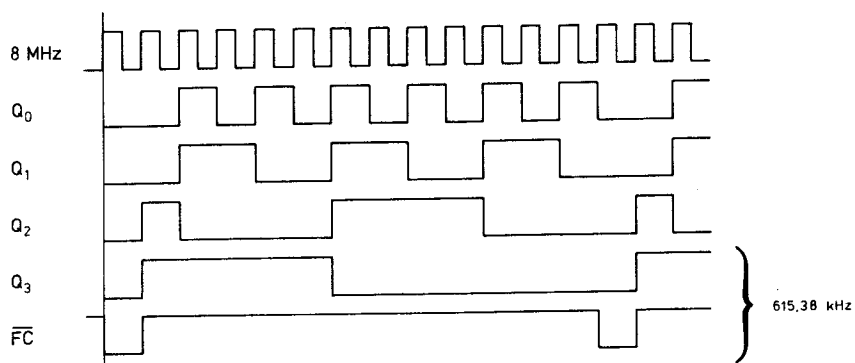

C - FDC WCK Generation

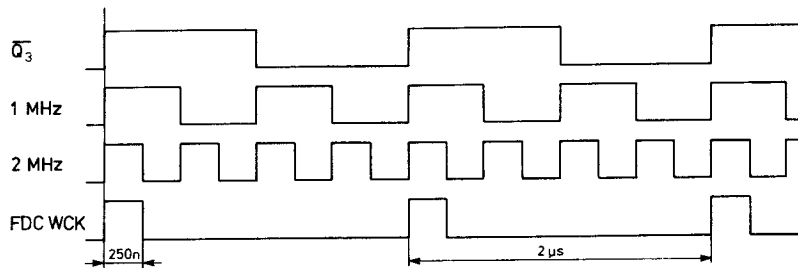
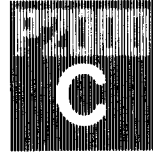
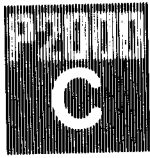

Figure 2.9 P2000C Clock Generator - Timing Diagrams

Detailed Description and Servicing
Mainboard - Clock Generator



THIS PAGE INTENTIONALLY BLANK



Detailed Description and Servicing
Mainboard - Clock Generator

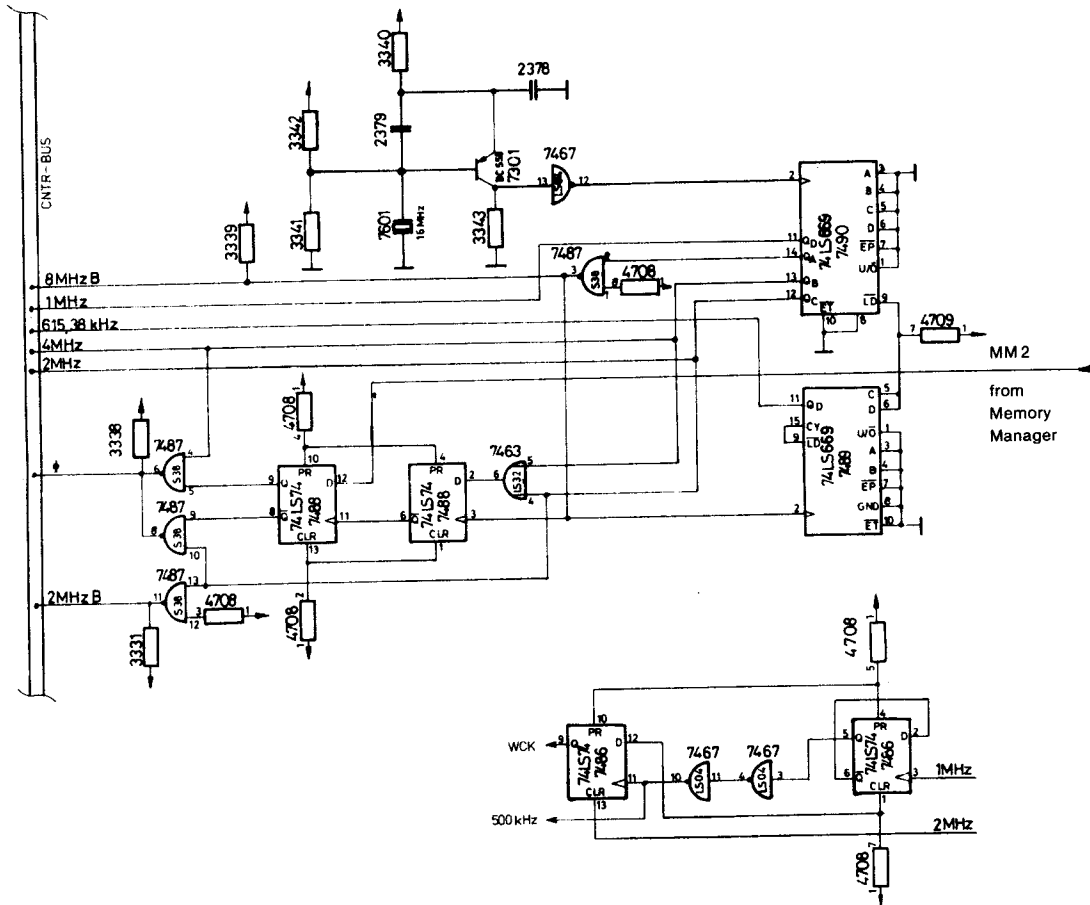

Figure 2.10 Circuit Diagram - Clock Generator

Detailed Description and Servicing
Mainboard - Clock Generator



THIS PAGE INTENTIONALLY BLANK



Detailed Description and Servicing
Mainboard - I/O Decoder

1 GENERAL

The I/O addresses are hard wired on the Mainboard. They are fully decoded, thus eliminating bus problems if the I/O is extended.

The I/O decoder handles the lower addresses (AB0 to AB7) and the bus control signals, in connection with DMA activities. The IORQB-N signal must be gated separately on each I/O component.

The decoder output signals are used as the chip select signals for the I/O devices.

2 BLOCK DIAGRAM

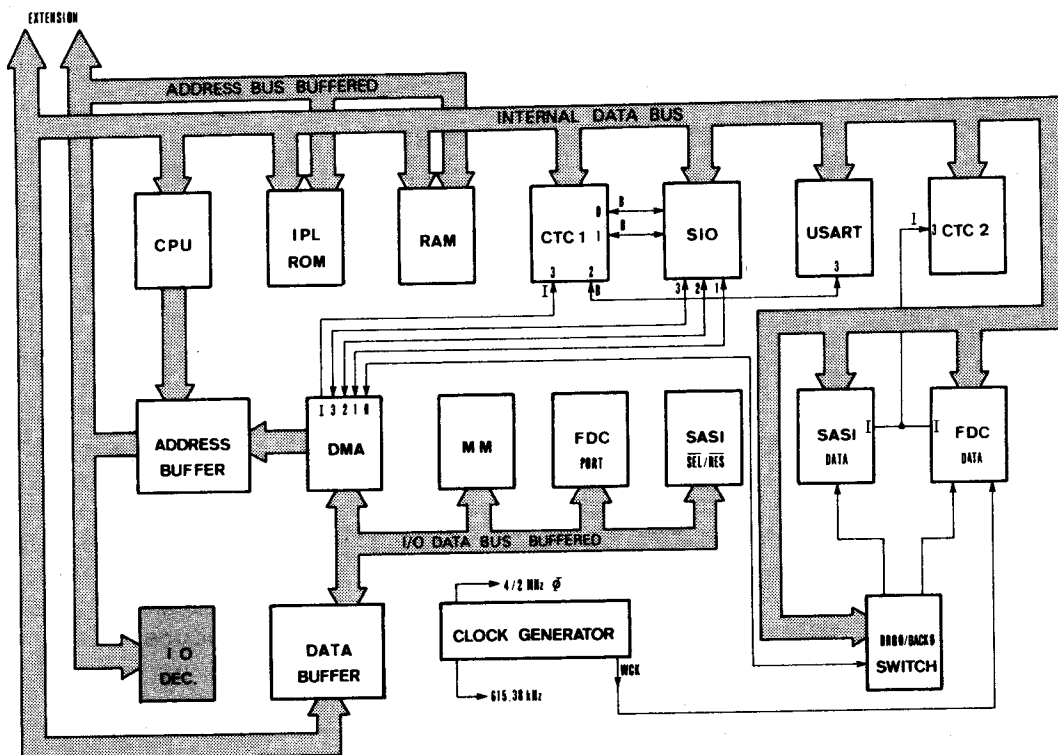
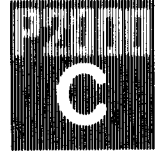

Figure 2.11 P2000C - I/O Decoder Block Diagram

Detailed Description and Servicing
Mainboard - I/O Decoder



3

CIRCUIT DESCRIPTION

Item 7476 is a dual 1 of 4 decoder. Providing that no DMA device is active and that there is no Interrupt Acknowledge Cycle in progress, active low states on AB6 and AB7 cause the 1Y1 output of item 7476 to be active low. This output enables the second half of item 7476 to decode AB4 and AB5, driving one of the three outputs 2Y0 to 2Y2 to active low. See figure 2.12

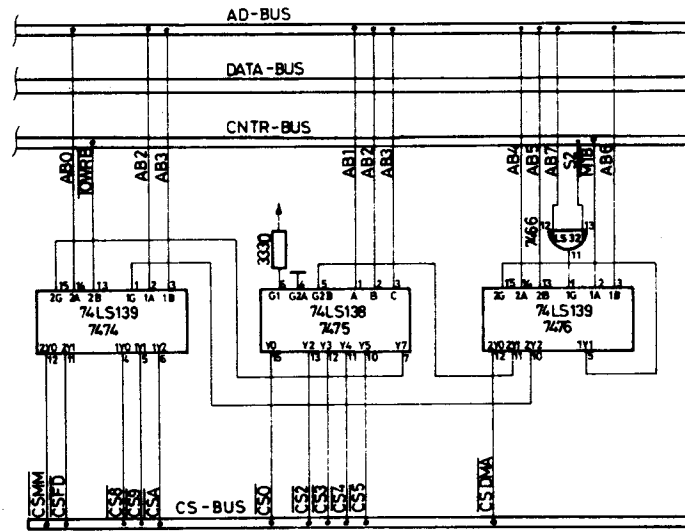

Figure 2.12 Circuit Diagram - I/O Decoder

If 2Y0 is active, then the DMA chip select - CSDMA-N - is active.

If 2Y1 is active (AB4=1, AB5=0, 1Y1=0), the signal is used to enable item 7475, a 1 of 8 decoder.

If 2Y2 is active (AB4=0, AB5=1, 1Y1=0), the signal is used to enable item 7474, the first part of a dual 1 of 4 decoder.

With 2Y1 active, item 7475 decodes AB1 to AB3. In this case, AB1 to AB3 (with address line ABO wired to the devices) give the majority of the I/O addresses in the range 10H to 1FH. The exceptions are the I/O addresses 1EH and 1FH. In these cases, high states on all three inputs make the output Y7 active, which in turn activates the second part of item 7474. In this case, ABO and IOWRB-N are decoded to produce chip select signals for either Memory Manager (CSMM-N) or Flexible Disk Port (CSFD-N).

With 2Y2 active, the first part of item 7474 decodes AB2 and AB3. With ABO and AB1 wired to the devices, this gives all addresses in the range 20H to 2FH.



Detailed Description and Servicing
Mainboard - I/O Decoder

The decoding is shown table 2.13:

Table 2.13 - I/O Decoding

IF ABO-AB7 ARE SET	ADDR	CIRCUIT DECODES	GIVING
<u>AB 7 6 5 4 3 2 1 0</u> 0 0 0 0 X X X X	OX	AB7,6,5,4 S2,M1B-N	CSDMA-N
<u>AB 7 6 5 4 3 2 1 0</u> 0 0 0 1 1 1 1 0 0 0 0 1 1 1 1 1	1EH 1FH	IOWRB-N AB0	CSMM-N CSFD-N
<u>AB 7 6 5 4 3 2 1 0</u> 0 0 0 1 0 0 0 1 0 0 0 1 0 1 0 1 0 0 0 1 0 1 1 1 0 0 0 1 1 0 0 1 0 0 0 1 1 0 1 1	11H 15H 17H 19H 1BH	AB3,2,1	CS0-N CS2-N CS3-N CS4-N CS5-N
AB0 is hard wired to the device.			
<u>AB 7 6 5 4 3 2 1 0</u> 0 0 1 0 0 0 1 1 0 0 1 0 0 1 1 1 0 0 1 0 1 0 1 1	23H 27H 2BH	AB3,2	CS8-N CS9-N CSA-N
AB0, AB1 are hard wired to the device.			

Detailed Description and Servicing
Mainboard - I/O Decoder



3.1 Mainboard I/O Addresses

The Mainboard I/O addresses are given below:

Address	Signal	Device	Direction
00 - 08	CSDMA-N	Intel 8257 DMA	read & write
09 - 0F		Do not use	
10, 11	CS0-N	Trigger IC 7443 (74LS107)	
12, 13	CS1-N	not used	
14, 15	CS2-N	8251A USART (for printer)	read & write
16, 17	CS3-N	SASI Data	read & write
18, 19	CS4-N	SASI Control	read & write
	read:		write:
	bit 0 : REQ		-
	bit 1 : C/D-N		-
	bit 2 : MSG		SEL-N
	bit 3 : BSY		RES-N
	bit 4 : I/O-N		-
	bit 7 : C/D-N		-
1A	CS5-N	NEC 765 FDC (status)	read & write
1B		NEC 765 FDC (data)	read & write
1C, 1D	CS6-N	not used	
1E	CSMM-N	Memory Manager bit 0 to bit 3 giving MM1 to MM4 (Set to 0 for IPL ROM; set to 2 for System RAM) (On RESET, IPL ROM is activated)	write only
1F	CSFDP-N	FDC Output Port bit 4 : NEC 765 reset (active '0') bit 5 : MOTON bit 6 : DS4EN (must be '1' to select Drive 4) bit 7 : SFSEL ('0' : FDC) ('1' : SASI)	write only
20 - 23	CS8-N	CTC I	read & write
24 - 27	CS9-N	CTC II	read & write
28 - 29	CSA	SIO (Communication)	read & write
2A - 2B		SIO (Terminal)	read & write
2C - 2F	CSB	not used	



Detailed Description and Servicing
Mainboard - Memory Manager

1 GENERAL

The memory manager is used to control the bank switching procedures:

- to switch between internal ROM and external RAM arrays and
- to switch over between internal RAM and the IPL ROM.

In all cases it is necessary, within each of the parallel storage areas, to have a common storage area kept free for possible information interchange between the blocks. An exception to this is external RAM access, where the function of the memory manager is handled by the external hardware.

The memory manager uses a 1024-Bit Bipolar Prom (256 x 4) 82 S 129.

2 BLOCK DIAGRAM

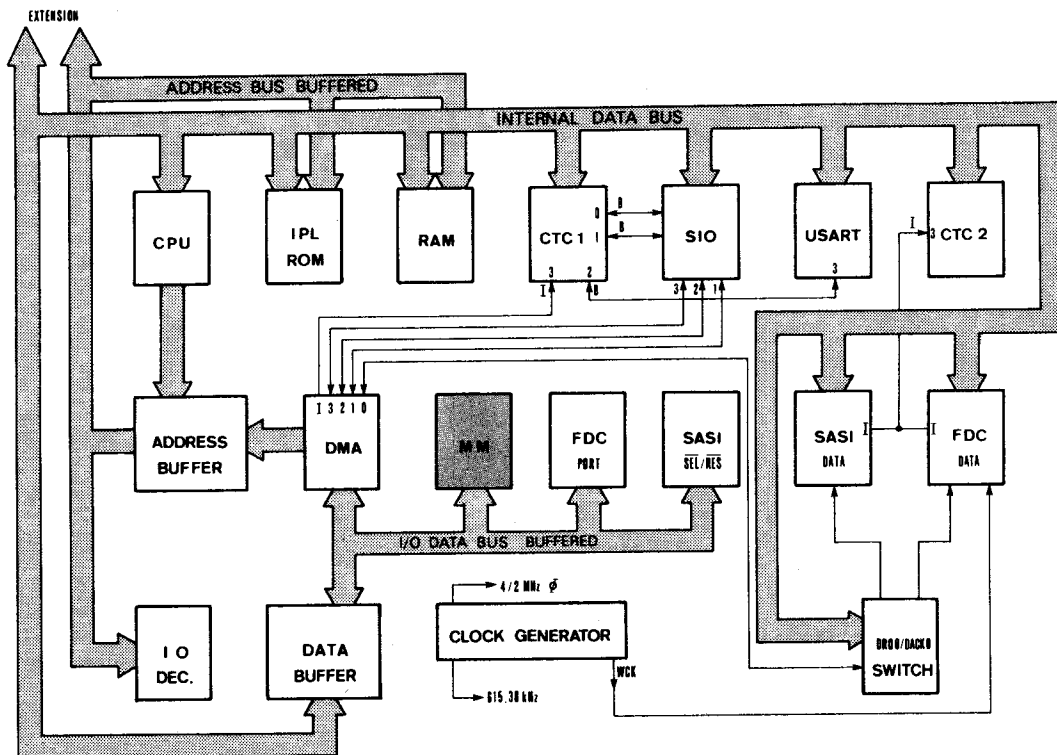
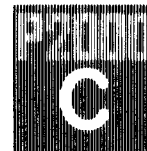

Figure 2.13 P2000C - Memory Manager Block Diagram

Detailed Description and Servicing
Mainboard - Memory Manager



3

CIRCUIT DESCRIPTION

The memory manager (item 7462) is controlled by:

- two memory manager signals
MM1 and MM2, (produced from two D-FF's 74 LS 74 - item 7446)
reachable via software with an output command to I/O address
1EH: bit 0 and bit 1
- the signal EXDIS-N
- the four highest address lines.

With these signals 3 memory activities can be selected. Combinations of MM1, MM2 and EXDIS-N not shown below are not allowed:

MM2	MM1	EXDIS-N	address area	activity
0	0	1	0 - 4 k	read from IPL ROM, write to internal RAM
0	0	1	above 4 k	internal RAM access
1	0	1	all	internal RAM access
1	1	0	all	external RAM access

Memory manager decoding is shown in table 2.14, on the following page.



Detailed Description and Servicing
Mainboard - Memory Manager

Table 2.14 - Memory Manager Decoding (I)

HEX ADDR	INPUTS							OUTPUTS	
	MM2 (A1)	MM1 (A0)	AB15 (A2)	AB14 (A3)	AB13 (A4)	AB12 (A5)	MREQB-N (CE-N)	ROMEN-N (O1)	RAMEN-N (O2)
00	0	0	0	0	0	0	0	0	1
20	0	0	0	0	0	1	0	1	0
10	0	0	0	0	1	0	0	1	0
30	0	0	0	0	1	1	0	1	0
08	0	0	0	1	0	0	0	1	0
28	0	0	0	1	0	1	0	1	0
18	0	0	0	1	1	0	0	1	0
38	0	0	0	1	1	1	0	1	0
04	0	0	1	0	0	0	0	1	0
24	0	0	1	0	0	1	0	1	0
14	0	0	1	0	1	0	0	1	0
34	0	0	1	0	1	1	0	1	0
0C	0	0	1	1	0	0	0	1	0
2C	0	0	1	1	0	1	0	1	0
1C	0	0	1	1	1	0	0	1	0
3C	0	0	1	1	1	1	0	1	0
01	0	1	0	0	0	0	0	1	1
21	0	1	0	0	0	1	0	1	0
11	0	1	0	0	1	0	0	1	1
31	0	1	0	0	1	1	0	1	1
09	0	1	0	1	0	0	0	1	1
29	0	1	0	1	0	1	0	1	1
19	0	1	0	1	1	0	0	1	1
39	0	1	0	1	1	1	0	1	1
05	0	1	1	0	0	0	0	1	1
25	0	1	1	0	0	1	0	1	1
15	0	1	1	0	1	0	0	1	1
35	0	1	1	0	1	1	0	1	1
0D	0	1	1	1	0	0	0	1	1
2D	0	1	1	1	0	1	0	1	1
1D	0	1	1	1	1	0	0	1	1
3D	0	1	1	1	1	1	0	1	1
02	1	0	0	0	0	0	0	1	0
22	1	0	0	0	0	1	0	1	0
12	1	0	0	0	1	0	0	1	0
32	1	0	0	0	1	1	0	1	0
0A	1	0	0	1	0	0	0	1	0
2A	1	0	0	1	0	1	0	1	0
1A	1	0	0	1	1	0	0	1	0
3A	1	0	0	1	1	1	0	1	0
06	1	0	1	0	0	0	0	1	0
26	1	0	1	0	0	1	0	1	0
16	1	0	1	0	1	0	0	1	0
36	1	0	1	0	1	1	0	1	0
0E	1	0	1	1	0	0	0	1	0
2E	1	0	1	1	0	1	0	1	0
1E	1	0	1	1	1	0	0	1	0
3E	1	0	1	1	1	1	0	1	0
03	1	1	0	0	0	0	0	1	0
23	1	1	0	0	0	1	0	1	0
13	1	1	0	0	1	0	0	1	0
33	1	1	0	0	1	1	0	1	0
0B	1	1	0	1	0	0	0	1	0
2B	1	1	0	1	0	1	0	1	0
1B	1	1	0	1	1	0	0	1	0
3B	1	1	0	1	1	1	0	1	0
07	1	1	1	0	0	0	0	1	0
27	1	1	1	0	0	1	0	1	0
17	1	1	1	0	1	0	0	1	0
37	1	1	1	0	1	1	0	1	0
0F	1	1	1	1	0	0	0	1	0
2F	1	1	1	1	0	1	0	1	0
1F	1	1	1	1	1	0	0	1	0
3F	1	1	1	1	1	1	0	1	0

Detailed Description and Servicing
Mainboard - Memory Manager

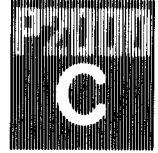

The decoder table given in table 2.14 is repeated in table 2.15 with the addresses given in numerical order. The column DATA shows the decoder outputs (ROMEN-N, RAMEN-N) in hexadecimal.

Table 2.15 - Memory Manager Decoding (II)

ADDR	DATA	ADDR	DATA	ADDR	DATA
00	2	16	1	2C	1
01	3	17	1	2D	3
02	1	18	1	2E	1
03	1	19	3	2F	1
04	1	1A	1	30	1
05	3	1B	1	31	3
06	1	1C	1	32	1
07	1	1D	3	33	1
08	1	1E	1	34	1
09	3	1F	1	35	3
0A	1	20	1	36	1
0B	1	21	1	37	1
0C	1	22	1	38	1
0D	3	23	1	39	3
0E	1	24	1	3A	1
0F	1	25	3	3B	1
10	1	26	1	3C	1
11	3	27	1	3D	3
12	1	28	1	3E	1
13	1	29	3	3F	1
14	1	2A	1		
15	3	2B	1		

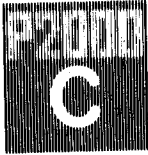

Detailed Description and Servicing
Mainboard - Memory Manager

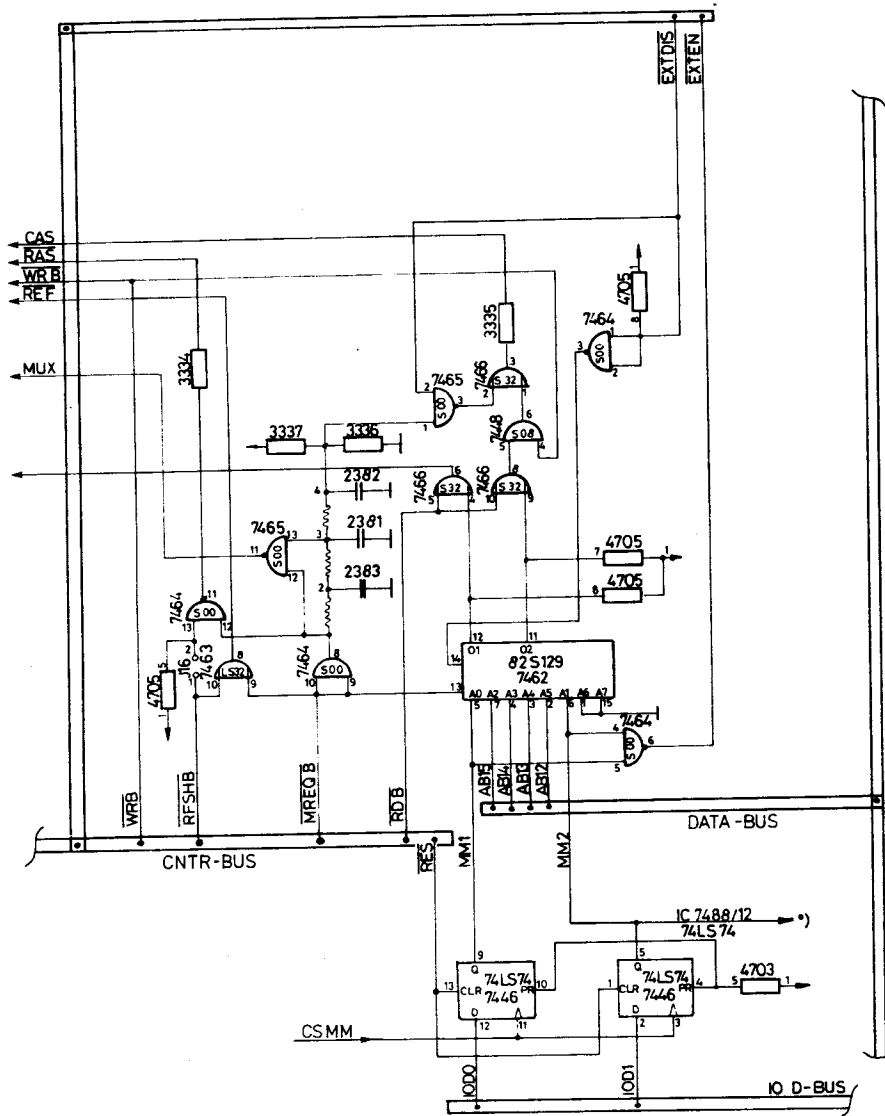
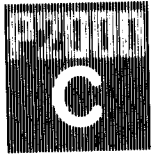

Figure 2.14 Circuit Diagram - Memory Manager

Detailed Description and Servicing
Mainboard - Memory Manager



THIS PAGE INTENTIONALLY BLANK



Detailed Description and Servicing
Mainboard - Random Access Memory

1

GENERAL

The P2000C Mainboard includes a 64 kByte array of HM 4864-2 random access memories. The HM 4864 is a 65,536-words by 1-bit, MOS random access memory circuit fabricated with double-poly N-channel silicon gate process for high performance and high functional density. It uses a single transistor dynamic storage cell and dynamic control circuitry to achieve high speed and low power dissipation. In addition to the usual read, write, and read-modify-write cycles, the HM 6864 is capable of delayed write cycles, page-mode operation and RAS-N-only refresh. Full details of the HM 4864 RAM can be found in the Hitachi Data Sheets HM 4864-2 and HM 4864-3.

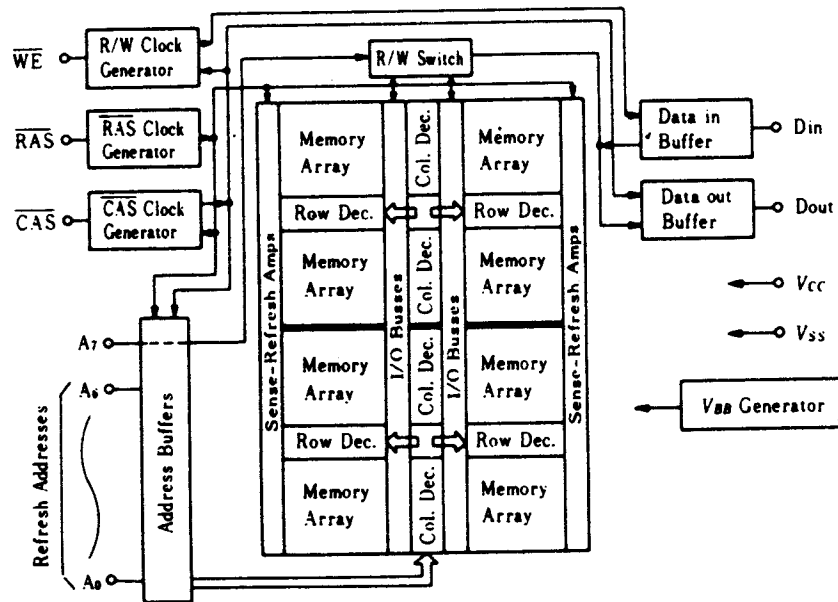
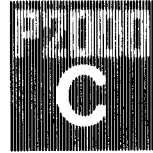

Figure 2.15 HM 4864 - Block Diagram

Detailed Description and Servicing
Mainboard - Random Access Memory



2 BLOCK DIAGRAM

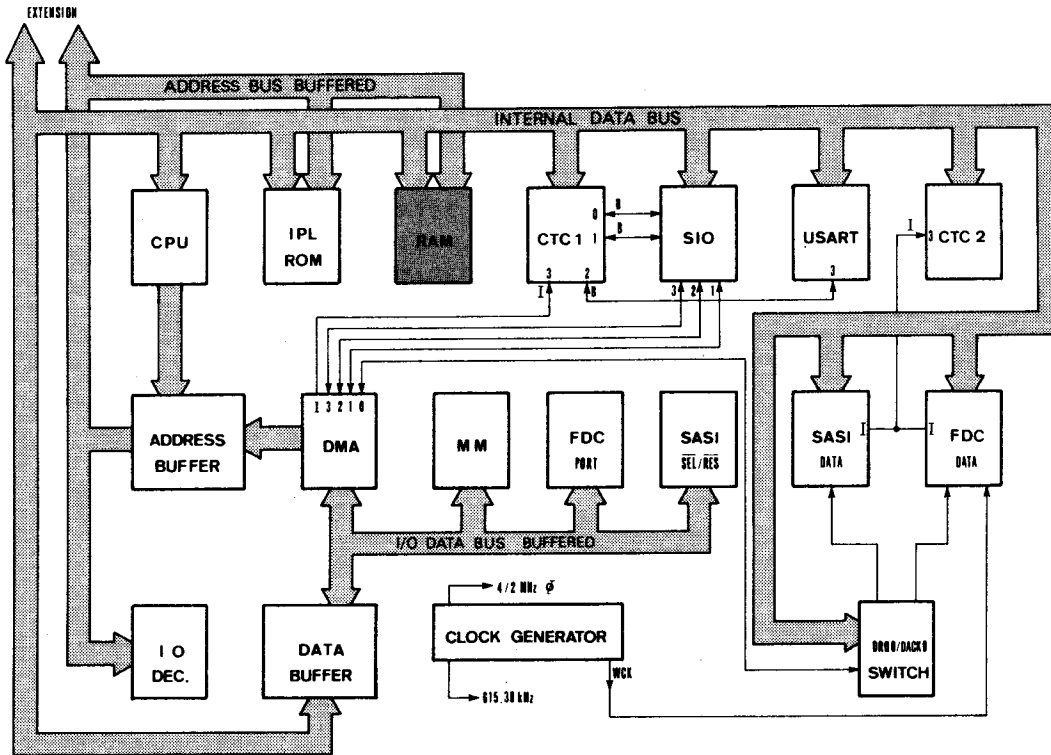

Figure 2.16 P2000C - Random Access Memory Block Diagram



Detailed Description and Servicing
Mainboard - Random Access Memory

3

CIRCUIT DESCRIPTION

The RAM's (items 7478 - 7485) are addressed via the multiplexed address bus. The MUX signal (formed from MREQB-N) latches the lower 8 addresses to the dynamic RAM's. The MUX signal is formed by the first two sections of the delay line, 20 ns after the RAS-N, allowing time to write data to the RAM's. The two multiplexers 74 S 157 (items 7472/7473) are then switched over to put the higher addresses to the RAM's. On the third branch of the delay line the CAS-N signal becomes active after a further delay of about 10 ns. This signal is now gated with the output signals of the memory manager and the WRB-N and RDB-N signals. (See Memory Manager).

The WRB-N signal is used to ensure that the CAS-N signal will not be applied to the RAM's before the WRB-N signal has changed its state, as this signal becomes active very late on the Z 80. The serially arranged resistors on the multiplexer are used to avoid signal undershoot (negative voltage on the RAM inputs).

The HITACHI HM 4864-2 RAM fits into the requirements as shown below:

BASIC REQUIREMENTS	HM 4864-2
- t RAC (access time from RAS) = 198 ns maximum	150 ns max
- t CAC (access time from CAS) = 162 ns maximum	100 ns max
- t RP (RAS precharge time) = 103 ns minimum	100 ns min

The refresh is done automatically by the CPU, after each Opcode fetch, using the RAS-N pulse (for the RAS-N-only refresh) derived from the MERQB-N. With the use of the HM 4864-2 RAM's, the RFSHB-N signal is not used.

At the refresh, MREQB-N will be active and both WRB-N and RDB-N will be inactive, so CAS-N will not reach the RAM's. However, the layout is designed to use RAM's with a separate refresh input (suppression of the RAS-N during refresh, RFSHB-N on the right pin).

Note: To use RAM's with separate refresh inputs, the jumpers J16 and J17 must be closed.

For situation of RAM's in relation to other Mainboard circuits, please refer to the full circuit diagrams.

Detailed Description and Servicing
Mainboard - Random Access Memory

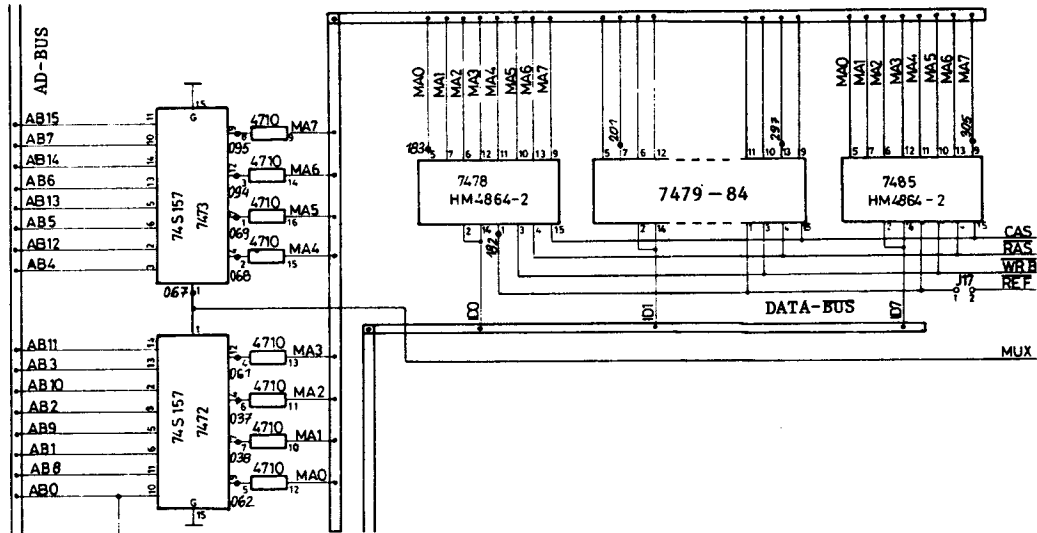
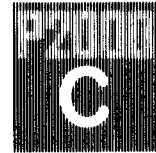

Figure 2.16a Circuit Diagram - Random Access Memory



Detailed Description and Servicing
Mainboard - IPL ROM

1 GENERAL

The basic IPL ROM used in the P2000C is a 32 k bit (4k x 8), the Intel 2732A EPROM. For special requirements it is possible to fit larger ROMs.

- 64 k bit (8k x 8 - Intel 2764-6)
- 128 k bit (16k x 8 - Intel 27128)

The IPL ROM occupies position 7456 on the Mainboard.

It should be noted that the system clock is switched from the normal 4MHz to 2MHz for the IPL operation to allow the reading of slower ROMs. As the access time for these devices is a maximum of 450ns, the access time of 525ns given by using the 2MHz system clock makes it unnecessary to use Wait Logic.

2 BLOCK DIAGRAM

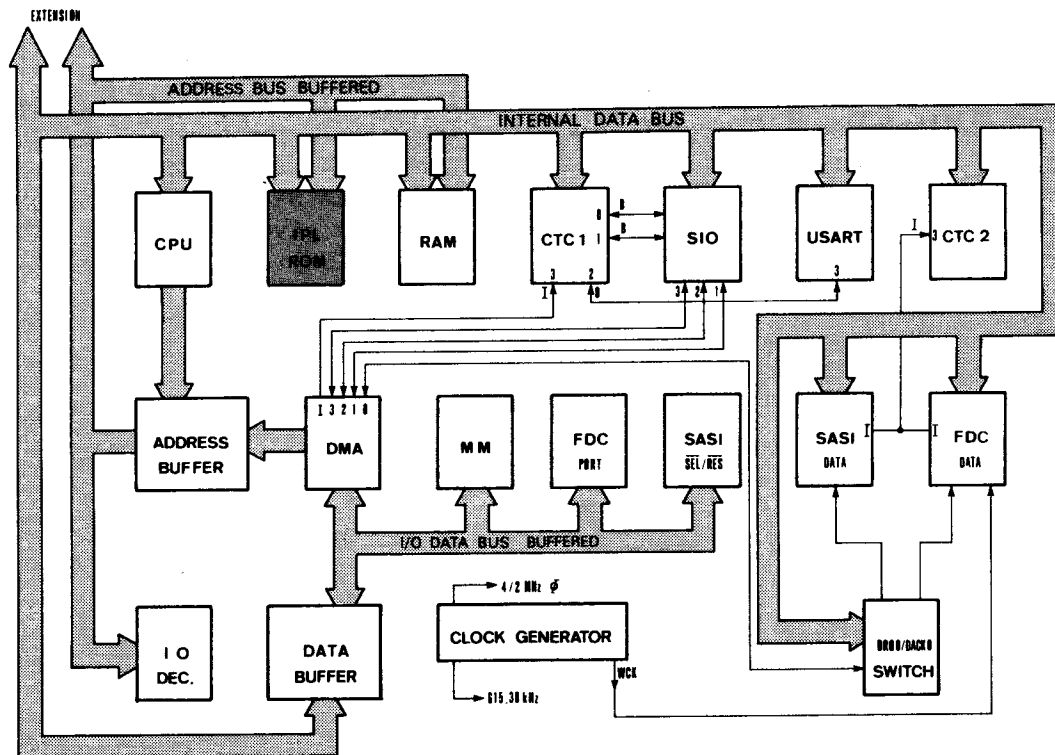

Figure 2.17 IPL ROM - Block Diagram

Detailed Description and Servicing
Mainboard - IPL ROM



3 PINNING

The 28 pin IC socket (at item position 7456) accepts either of the larger ROMs, using all pins, and the 32 k bit ROM leaving 4 pins unused. The unused pins are 1, 2, 27 and 28, as related to the 64 k bit ROM.

4 JUMPER J21

This jumper applies Vcc to the 32 k bit and 64 k bit ROMs in the normal position - pins 1 and 2 connected. If the 128 k bit ROM is used it is necessary to open pins 1 and 2 and to close pins 3 and 4 (input of highest address bit).

5 FUNCTION OF IPL

The purpose of the IPL (Initial Program Load) is to carry out the bootloading of the system software on switch-on (or RESET). The IPL program is first transferred to RAM and then executed. The program accesses the bootload devices in turn and, if valid 'system software' is found, transfers control information to RAM. The IPL information is overwritten at this time.

If valid data is not found the message SYSTEM DISK? is displayed. The IPL program includes a DEBUGGER program which permits basic testing of the system. The DEBUGGER can be called up by pressing the ESC key when the SYSTEM DISK? message is displayed. Details of this program are given in part 2, chapter 1 of this manual (Basic I/O System - BIOS).

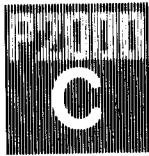

Detailed Description and Servicing
Mainboard - S A S Interface

1 GENERAL

The SASI (Shugart Associates Standard Interface) is an 8 bit parallel bus which is able to control a maximum of 8 devices. The main purpose of SASI is to connect computers to storage media which require an intelligent interface. (Floppy disks, Hard disks)

The SASI, as implemented on the P2000C Mainboard, does not use the full SASI specification. It is similar to the XEBEC Controller on the Hard Disk.

- Transfers can only be initiated from the Mainboard
- Only one target can be active at any time
- The Arbitration and Reselection phases are not implemented

2 BLOCK DIAGRAM

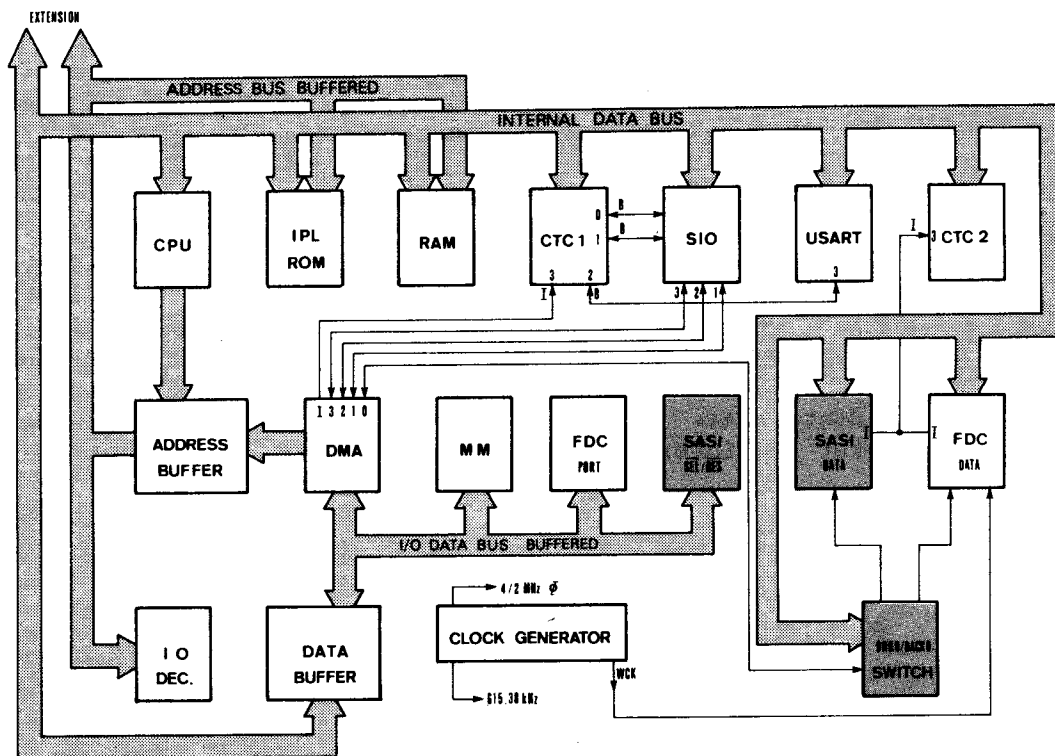

Figure 2.18 P2000C - SASI Block Diagram

Detailed Description and Servicing
Mainboard - S A S Interface



3 CIRCUIT DESCRIPTION

3.1 Description of a Data Transfer

CPU TRANSFER

After the establishment of the path between the Initiator (Mainboard) and the Target (storage controller) and the transfer of the necessary control data (data address, block length, direction of transfer) the data transfer starts. The Target announces a data request (REQ = "1", C/D-N = "0"), releasing D-FF (Item 7429-1) from the clear state. In polled mode, the CPU acknowledges the Request state and then sends or reads data.

DMA TRANSFER

The 74 LS 156 decoder (item 7530) recognizes the request state because of the state of lines REQ and C/D-N and sets the D-FF (Item 7429-2). The Q output of the D-FF (Item 7429-1) gives the DRQ (Data Request) signal for the DMA Chip which, in turn, initiates the corresponding write or read command.

IN BOTH CASES (CPU/DMA)

The data read or write procedure leads to an active signal on the clear input of D-FF (Item 7429-1) (ACK-N is activated and informs the target that the information is ready to be fetched or that it has arrived.)

After a time the target cancels the REQ line and the D-FF (Item 7429-1) will be reset (ACK-N will be inactive again).

If an error occurs during the transfer the target is able to give a message (or a Status byte) to the Initiator. The 74 LS 156 Decoder recognizes such a state on the SASI control bus and generates an interrupt by using the CTC II Channel 3. The CTC II Channel 3 is used by both the SASI and the Floppy Disk Controller. It is the responsibility of the software to interpret the interrupt correctly.

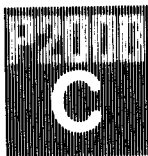

Detailed Description and Servicing Mainboard - S A S Interface

Note: SASI or FDC are selected by software via FDC output port using the SFSEL signal, both using the DMA channel 0. The FDC output port address is 1FH; bit 7 set to 1 means SASI active and FDC inactive. If SASI is selected, it is important that the FDC is reset by software to ensure that the DRQ FDC does not become active. If FDC is selected, the SFSEL signal ensures that the DRQ SASI does not become active, by setting D-FF (Item 7429-2) clear input.

An OR-gate (IC 7426, pins 11, 12 and 13) combines the two DRQ signals from SASI and FDC to produce one DRQO signal for the DMA chip.

Item 7410 (74 LS 240) is an inverting bus driver so, for example, C-N/D on the input corresponds to C/D-N on the output.

3.2

Driver Current Requirements

All lines of the SASI bus (excluding ACK-N, SEL-N and RES-N) must be terminated with 220 Ohm/330 Ohm resistor networks at each end, to prevent reflections (Item 4702 on the P2000C Mainboard). Each line has to be able to drive 7 Shottky components. In the case of the P2000C version of the SASI, the lines ACK-N, SEL-N and RES-N are used as outputs only and must be terminated (on the receiver side only) with a network having a value equal to the surge impedance. (LS components can now be used). The circuit arrangement is shown in figure 2.19.

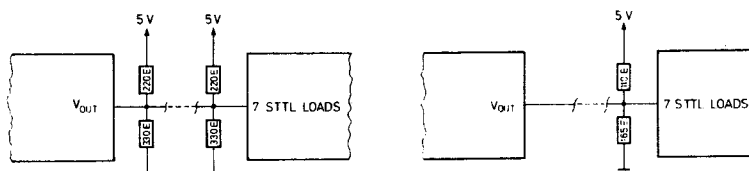

Figure 2.19 P2000C - SASI Line Terminators

Detailed Description and Servicing
Mainboard - S A S Interface



3.3 Control

The control ports (Input & Output) are accessed by the CPU with an I/O command. The data ports can be accessed with an I/O command by the CPU and also by the 8257 DMA. Because of this a fast data transfer to and from the storage media is possible.

3.4 I/O Addresses

16 or 17	CS3-N	SASI Data	read & write
18 or 19	CS4-N	SASI Control	read & write

read :	write :
bit 0 : REQ	only bit 2 and 3
bit 1 : C/D-N	used
bit 2 : MSG	bit 2 : SEL
bit 3 : BSY	bit 3 : RES
bit 4 : I/O-N	
bit 5 : not used	
bit 6 : not used	
bit 7 : C/D-N	

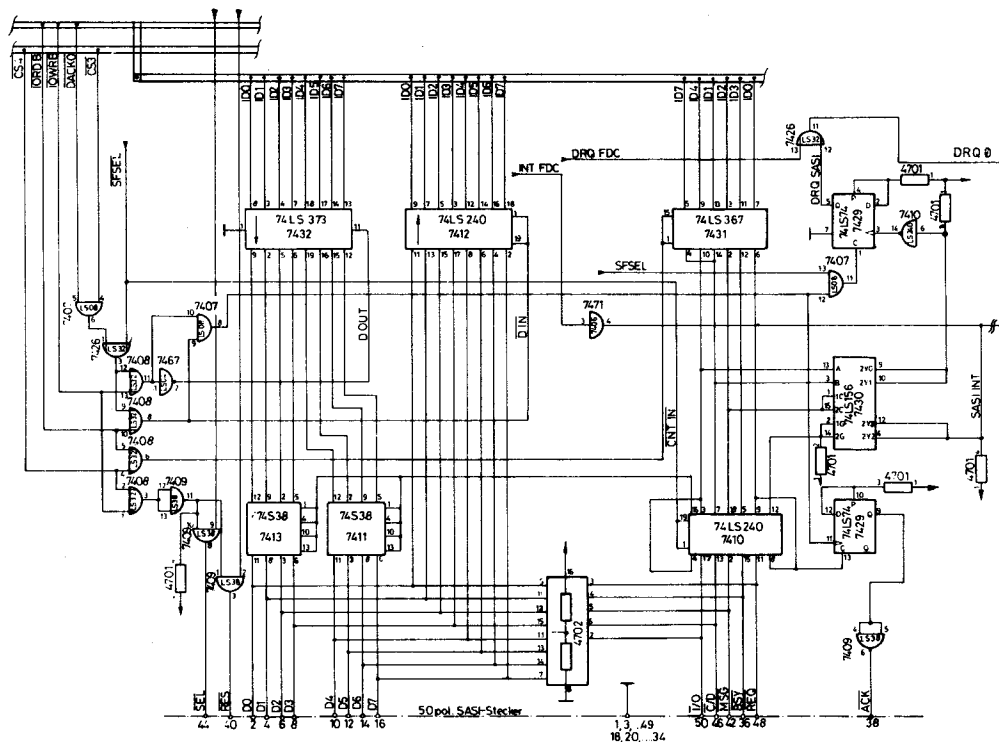

Figure 2.20 Circuit Diagram - SASI



Detailed Description and Servicing
Mainboard - Flexible Disk Controller

1 GENERAL

1.1 uPD 765 Disk Controller - General

The uPD 765 is an LSI Floppy Disk Controller (FDC) chip, which contains the circuitry and control functions for interfacing a processor to 4 Floppy Disk Drives. It is capable of supporting either IBM 3740 single density format (FM), or IBM System 34 Double Density format (MFM) including double sided recording. The uPD 765 provides control signals which simplify the design of an external phase locked loop, and write precompensation circuitry. The FDC simplifies and handles most of the burdens associated with implementing a Floppy Disk Interface. Figure 2.21 shows the main functions.

Full details of the uPD 765 can be found in the NEC Micro-computers Inc. Data Sheet.

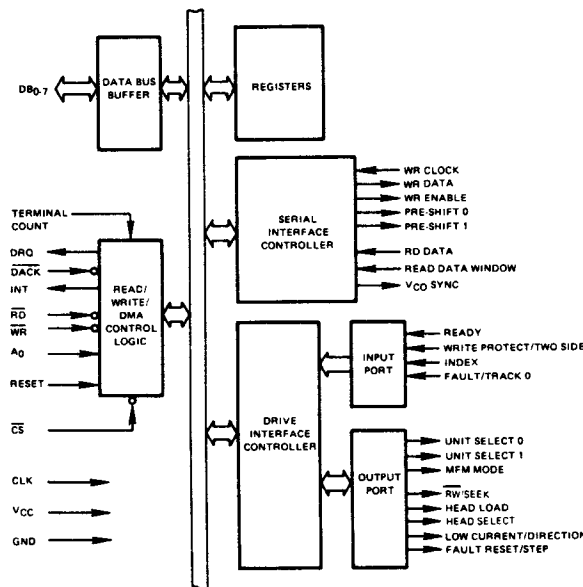
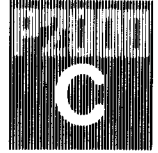

Figure 2.21 P2000C - FDC Block Diagram

11-2

Detailed Description and Servicing
Mainboard - Flexible Disk Controller

1.2 Application in P2000C

The flexible disk controller is designed to handle up to four single/double sided - single/double density - 5¼" flexible disk drives. See NEC Application Note 10 for the uPD 765.

1.3 Flexible Disk Controller Technology

The flexible disk controller, uPD 765, provides control over the following functions:

- disk formatting
- recalibration of head on track 0
- seeking specified track
- writing n sectors
- reading/writing deleted data
- scanning (comparing two disks track by track)
- software selectable data format and drive parameters

2 BLOCK DIAGRAM

Figure 2.22 P2000C - FDC Block Diagram



Detailed Description and Servicing
Mainboard - Flexible Disk Controller

3

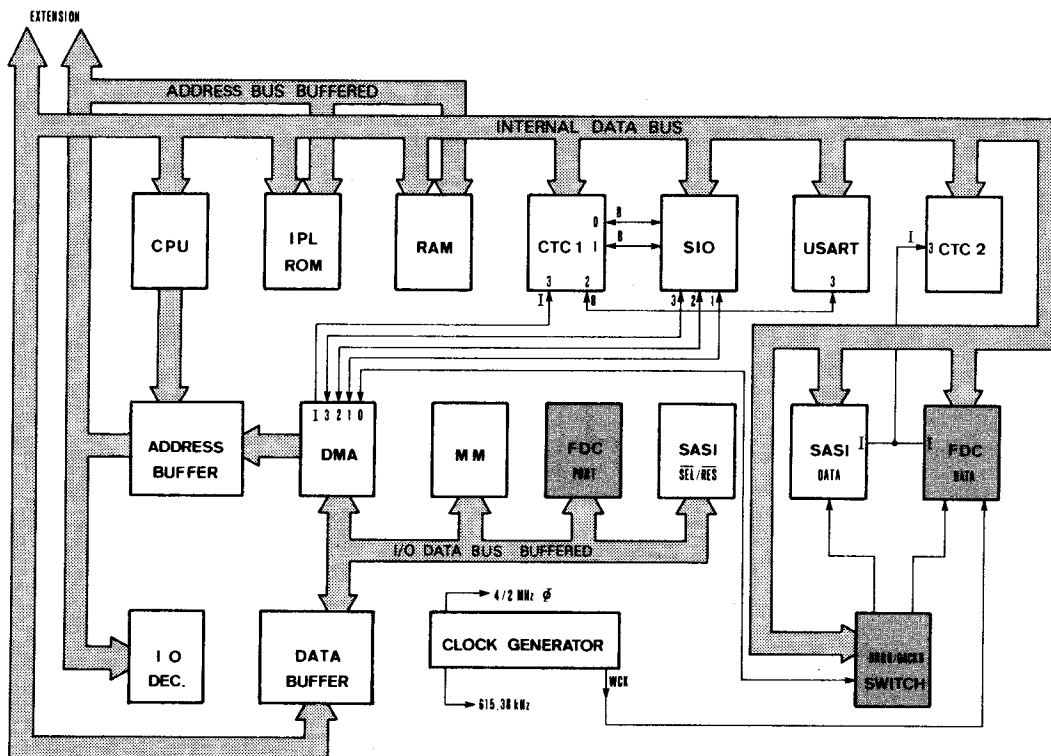
CIRCUIT DESCRIPTION

The data separator, PLL, performs the following functions:

- high quality data recovery
- an 8257 DMA chip controls access to and from RAM memory. (A bus request is given to the CPU before a memory transfer is required. The disk control unit DMA is then enabled by the CPU and controls memory accessing, thus allowing the CPU to proceed with other activities.)

Note: The following improvements have been made to the application circuit shown in NEC Application Note number 10:

- the current source (Q2 2N2222) used for adjusting the middle frequency of the VCO MC 4024 P (item 7417) has been replaced by a temperature compensated current source, consisting of two BC 549's (items 7302/7303). The frequency can be adjusted by using the potentiometer, item number 4712, detailed in paragraph 3.4. Full details of the MC 4024 P can be found in the Motorola Data Sheet for the device.
- to improve mid-frequency stability when no data is being received, some circuitry has been added. The 250 kHz signal, from the system clock, is fed to the PLL circuit via a multiplexer IC 7420 (4 x 74 LS 00). This signal replaces the data signal, ensuring that feedback is available in the closed control loop to prevent VCO frequency drift. The switch over of the signals is made by the VCO Sync signal from the uPD 765.

3.1

Integrated Circuits

IC 74 LS 244 - Item 7454

Additional explanation is necessary for this component. It is used as a demultiplexer and is controlled by the RW-N/SEEK signal. Two of the four leads are inputs, the other two are outputs. They have functions both in the R/W mode and in the SEEK mode. The STEP bus driver is also controlled by the RW-N/SEEK signal, to avoid faulty stepping during the switch over of the signal. This faulty stepping will also occur if the 74 LS 244 goes to the tri-state mode, because in this case the STEP line becomes 0.

Detailed Description and Servicing
Mainboard - Flexible Disk Controller

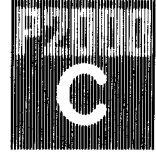

IC 74 LS 175 - Item 7452 FDC Output Port

This 4 bit output port (I/O address 1FH write only) is software controlled and fulfils 4 functions:

bit 4: a logic "0" resets the NEC 765 FDC

bit 5: "motor on" signal

bit 6: drive select enable; must be "1" to address drive 4

Note: Two outputs are implemented in the FDC for selecting 4 drives. If no drive is addressed both outputs are high, thus selecting drive 4, and the select LED of this drive is permanently active although the drive is not accessed. The drive 4 select enable signal is for inhibiting this unwanted mode.

bit 7: SFSEL "0" FDC active
 "1" SASI active

FDC and SASI use the same DMA channel (channel 0) and the same interrupt input on the CTC II (channel 3). With this control bit the system software determines the source/target of data transfer or interrupt. The unused function must always be inactive.

3.2

Flexible Disk Controller Hardware Interface

The flexible disk controller connections to the 5 $\frac{1}{4}$ " flexible disk drive are via a 34-pin connector and are as follows:

PIN	PURPOSE
2	spare
4	head load/in use
6	drive select 4
8	index
10	drive select 1
12	drive select 2
14	drive select 3
16	motor on
18	direction
20	step
22	write data
24	write gate
26	track 0
28	write protect
30	read data
32	side select
34	ready

Pins 1,3,5,...33 are connected to ground.

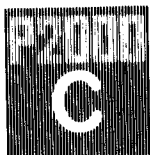

Detailed Description and Servicing
Mainboard - Flexible Disk Controller

11-5

3.3

Flexible Disk Controller Software Interface (I/O Ports)

The standard addresses for I/O devices are:

PORT	USAGE
1AH,1BH	Read/write output port
1FH	CS FDP write only
	bit 4 FDC RESET
	bit 5 MOTON
	bit 6 DS4EN
	bit 7 SFSEL: 0 = FDC
	1 = SASI

3.4

Adjustment of VCO Middle Frequency

The following procedure should be used to adjust the VCO middle frequency:

- apply power to the Mainboard
- connect pin 3 of item 7415 (IC 74 LS 221) to ground
- measure the frequency on TP2 (using a frequency counter)
- adjust the frequency to 500 kHz +/-1% using the potentiometer item 4712

The monoflop should then be adjusted as follows:

- remove the connection between pin 3 of item 7415 and ground
- examine the waveform on TP1 (using an oscilloscope)
- measure the time between falling and rising edges of the waveform
- adjust the time to as near as possible to 1 microsecond using the potentiometer item 4713

Detailed Description and Servicing
Mainboard - Flexible Disk Controller

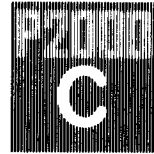

4

TIMING DIAGRAMS

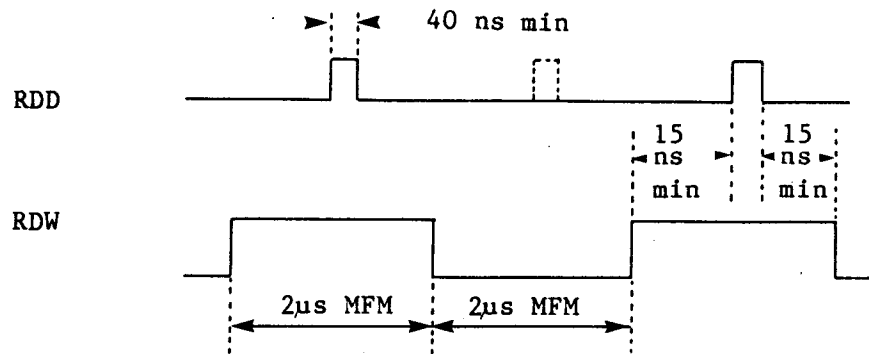

Input Data Timing

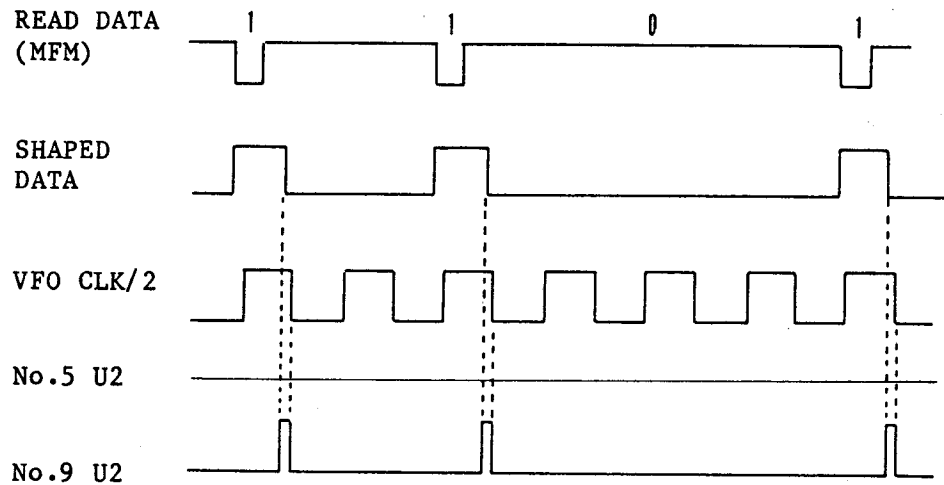

Phase Detector - CLK Lagging Shaped Data

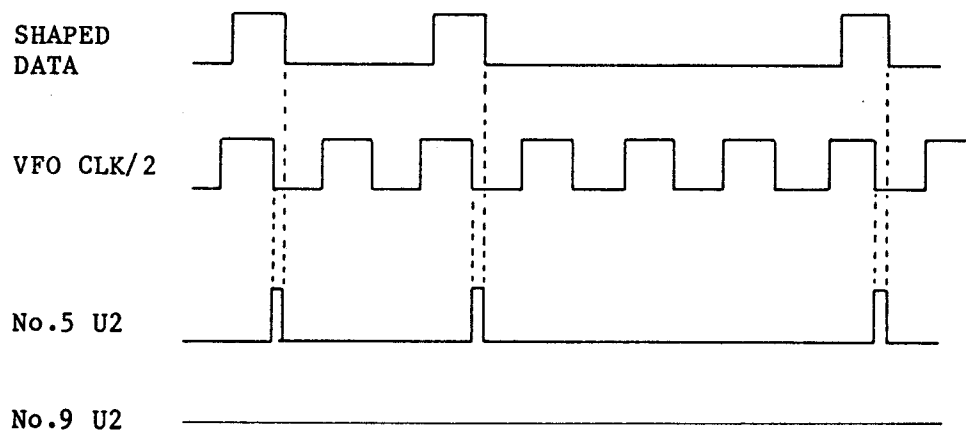

Phase Detector - CLK Leading Shaped Data

Figure 2.23 - FDC Timing Diagram



Detailed Description and Servicing
Mainboard - Flexible Disk Controller

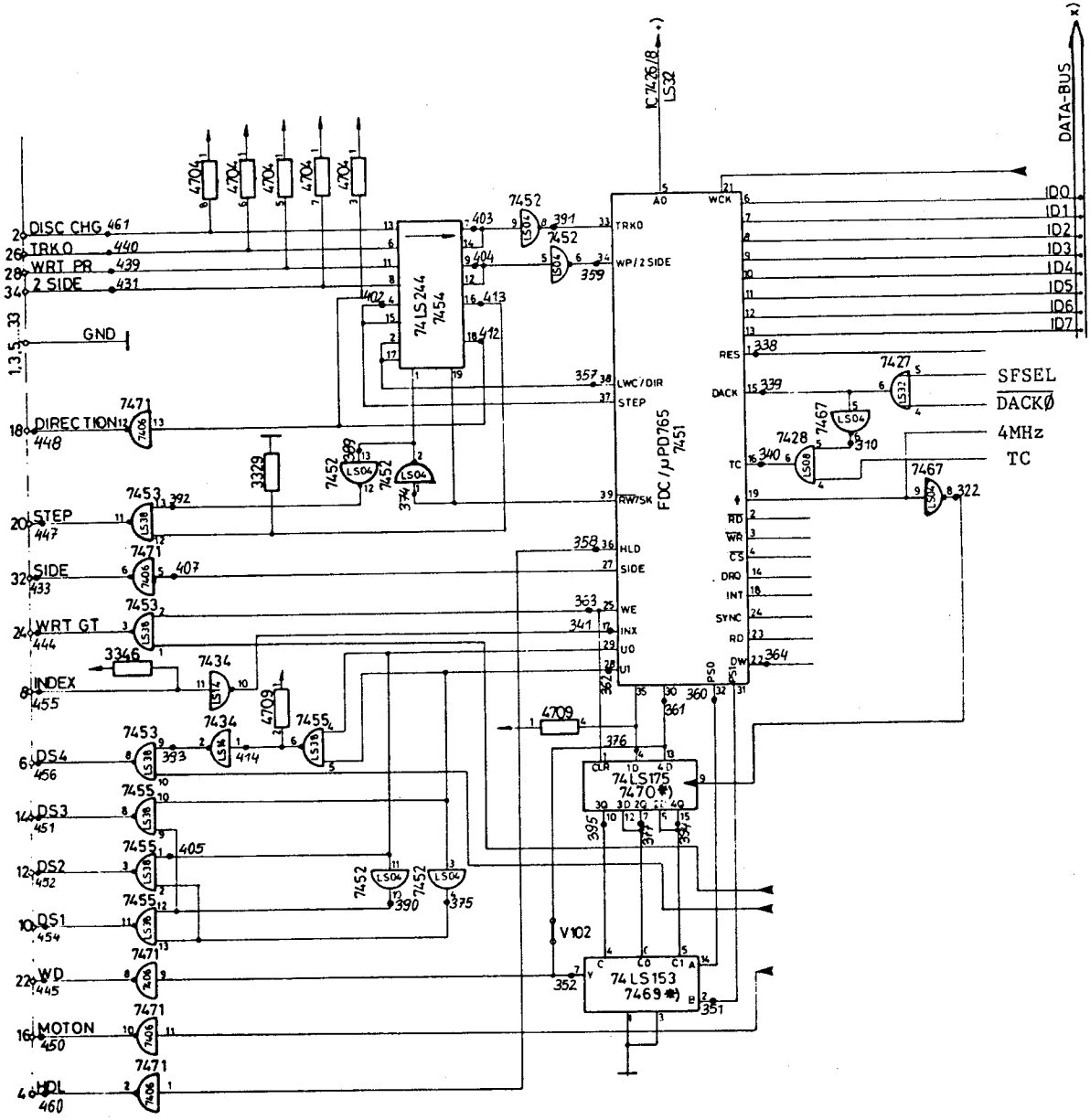

Figure 2.24 Circuit Diagram - Flexible Disk Controller

Detailed Description and Servicing
Mainboard - Flexible Disk Controller

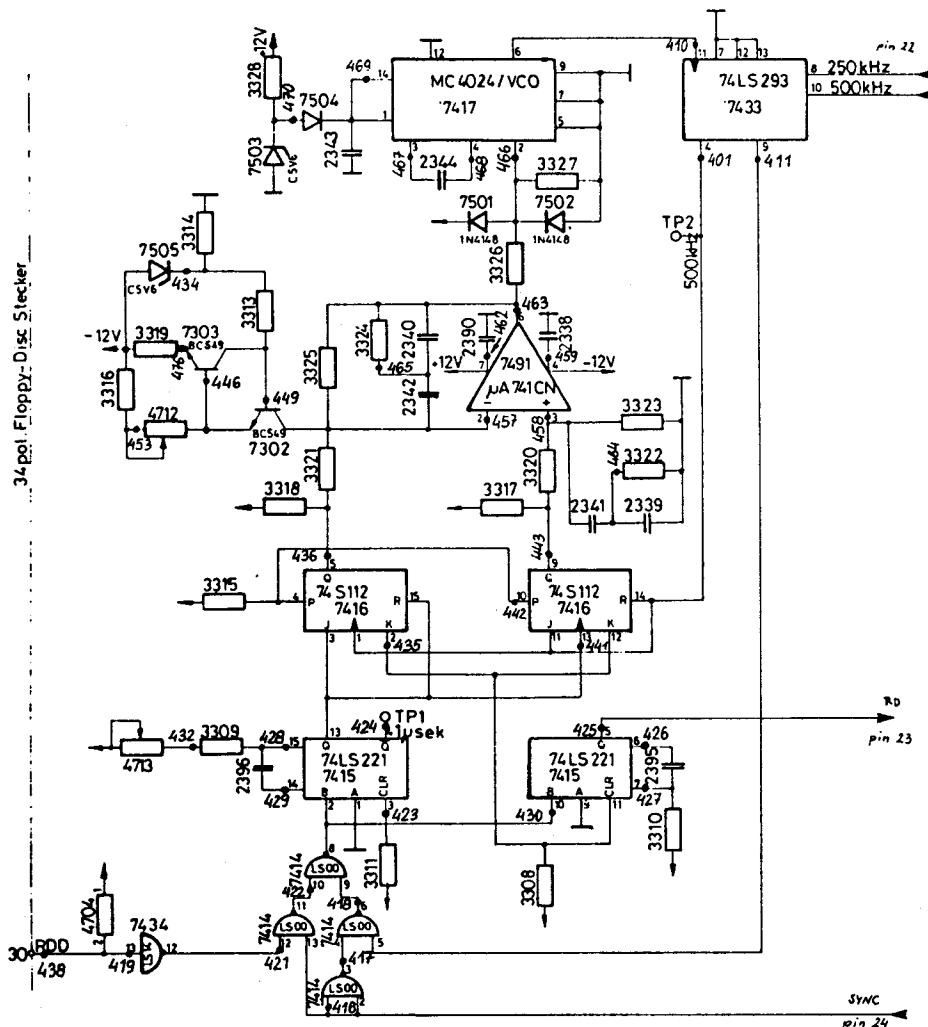
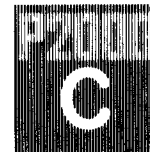

Figure 2.24 Circuit Diagram - Flexible Disk Controller (PLL)



Detailed Description and Servicing
Mainboard - Baud Rate Generator - C T C

1

GENERAL

The P2000C uses two Z80A CTC Counter/Timer Circuits (Z8430A). The main features of the Z80A CTC are:

- Four independently programmable counter/timer channels, each with a readable downcounter and a selectable 16 or 256 prescaler. Downcounters are reloaded automatically at zero count.
- Three channels have Zero Count/Time Out outputs capable of driving Darlington transistors.
- Selectable positive or negative trigger initiates time operation.
- Standard Z80 Family daisy-chain interrupt structure provides fully vectored interrupts (with priority levels) without external logic. The CTC may also be used as an interrupt controller.
- Interfaces directly to the Z80 CPU or to the Z80 SIO for baudrate generation.

Full details of the Z80A CTC can be found in the Z8430A Product Specification.

The CTC has four major elements, as shown in figure 2.24

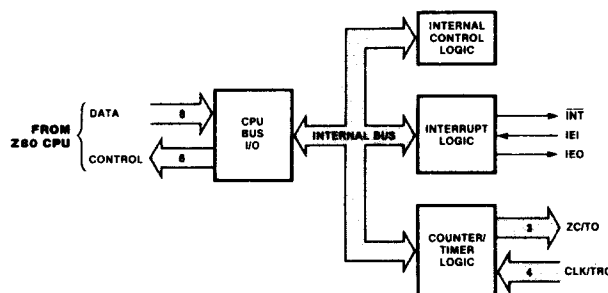

Figure 2.25 Z80A CTC - Block Diagram



Detailed Description and Servicing
Mainboard - Baud Rate Generator - C T C

2

BLOCK DIAGRAM

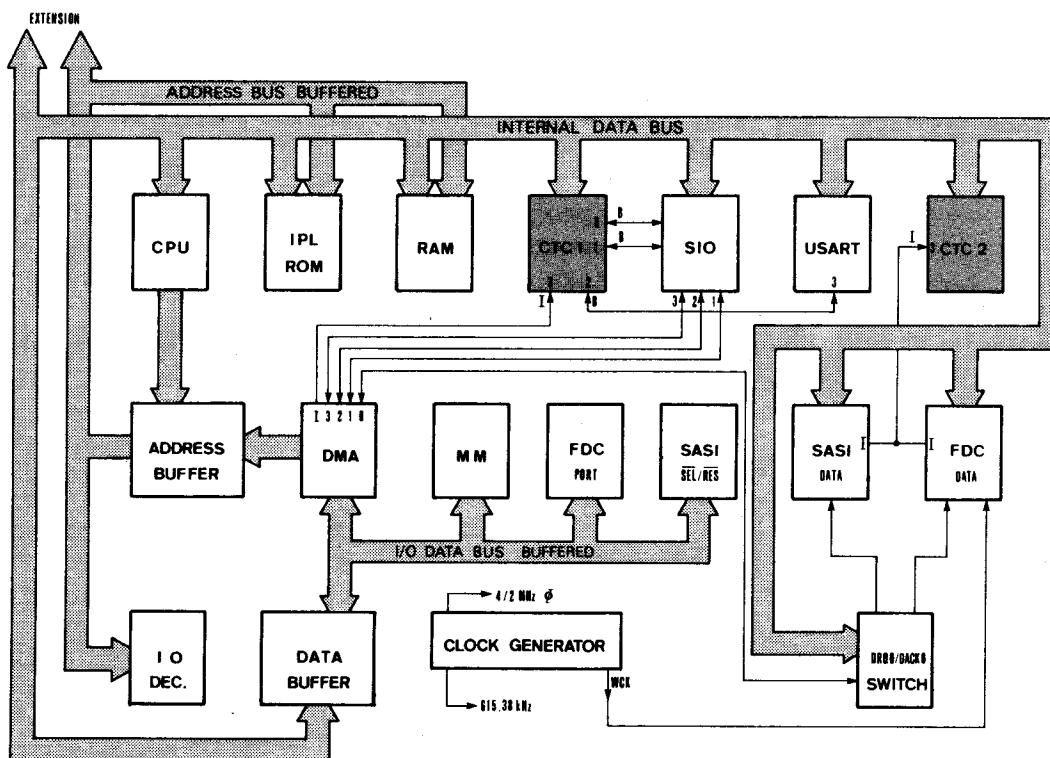
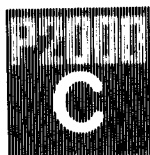

Figure 2.26 P2000C - CTC Block Diagram



Detailed Description and Servicing
Mainboard - Baud Rate Generator - C T C

3 CIRCUIT DESCRIPTION

The CTC's in the P2000C are used both as baudrate generators and interrupt controllers for the system timer and for non-Z80 devices.

3.1 CTC 1

CTC 1 (item 7449) modifies the input signal (615.38 KHz) to produce the signals 'TC0' and 'TC1' which are divided by 2 in the D-flip flops (item 7447), resulting in ASYN0 and ASYN2. ASYN 1 is a direct output.

3.2 CTC 2

Channel 2 of CTC 2 (item 7450) is used to monitor an external interrupt on the bus extension connector or for baudrate signal generation (ASYN3). A jumper (J15) is used to determine the function of this channel. (Pins 2 & 3 normally connected). Channels 0 and 1 of CTC 2 (item 7450) are cascaded and can be used as the system clock or clock/timer by the BIOS. The output of channel 0 is connected to an optional connector (PC), giving the possibility of a simple sound source.

CTC 1 INPUTS & OUTPUTS

	I/O ADD	INPUT	OUTPUT	REMARKS	OUTPUT SIGNAL
Ch.0	20H	CLK	ZC/T00	/2 (D-FF)	= ASYN0
Ch.1	21H	CLK	ZC/T01		= ASYN1
Ch.2	22H	CLK	ZC/T02	/2 (D-FF)	= ASYN2
Ch.3	23H	TC	-	DMA INT	

CTC 2 INPUTS & OUTPUTS

	I/O ADD	INPUT	OUTPUT	REMARKS	OUTPUT SIGNAL
Ch.0	24H	ZC/T01	ZC/T00	PC (sound)	
Ch.1	25H	CLK	ZC/T01	CLO & CL2	
Ch.2	26H	ZC/T01-			
		EINT	ZC/T02		= ASYN3
Ch.3	27H	TC	-	SASI/FDC INT	

Detailed Description and Servicing
Mainboard - Baud Rate Generator - C T C

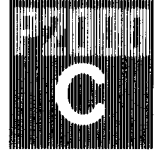

3.3 Baud Rate Relationships

The relationships between the system clock, scaling factors and final baud rates are shown in the following tables. The shading shows an example of the use of the tables.

Baud Rate	SIO Clock Mode		
	x16	x32	x64
75	/////	2,400	4,800
150	2,400	4,800	9,600
300	4,800	9,600	19,200
600	9,600	19,200	38,400
1200	19,200	38,400	76,800
2400	38,400	76,800	153,600
4800	76,800	153,600	307,200
9600	153,600	307,200	614,400
19200	307,200	614,400	/////

Clock Speed	CTC Time Constant		
	ASYN1 21H	ASYN3 26H	ASYN2 22H
2,400	0	0	////
4,800	128	128	0
9,600	64	64	128
19,200	32	32	64
38,400	16	16	32
76,800	8	8	16
153,600	4	4	8
307,200	2	2	4
614,400	1	1	2

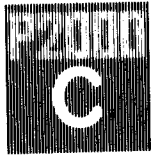

Detailed Description and Servicing
Mainboard - Baud Rate Generator - C T C

A summary of the Z80A CTC programming is shown in figure 2.26. Full details of the CTC can be found in the Z8430 Z80A CTC Product Specification.

CTC CHANNEL INTERRUPTS WHEN 01H IS DECREMENTED TO 00H

TIME CONSTANT	DECIMAL COUNTS TO INTERRUPT
01H	1
.	.
.	.
FFH	255
00H	256

REGISTER SELECTION

SELECT LINES CS1	CS0	CHANNEL SELECTED	PRIORITY
0	0	0	HIGHEST
0	1	1	
1	0	2	
1	1	3	LOWEST

READ = DOWN COUNTER
WRITE = CONTROL REGISTER

Interrupt Vector Word

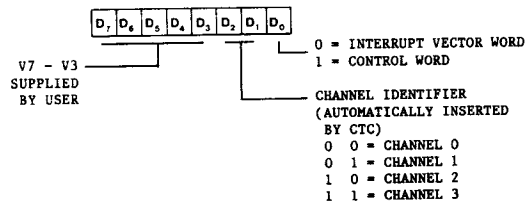

Channel Control Word

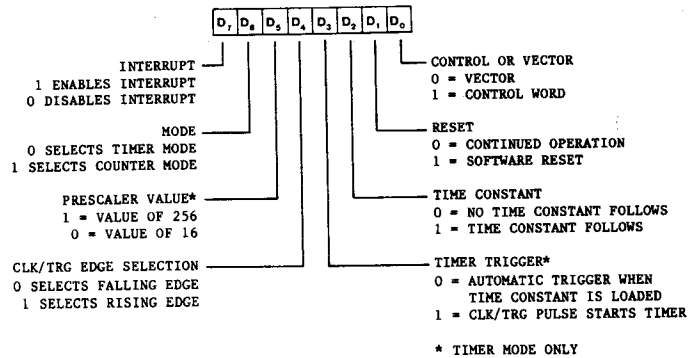

Time Constant Word

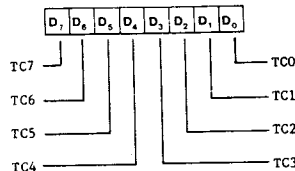

Figure 2.27 CTC Programming

Detailed Description and Servicing
Mainboard - Baud Rate Generator - C T C

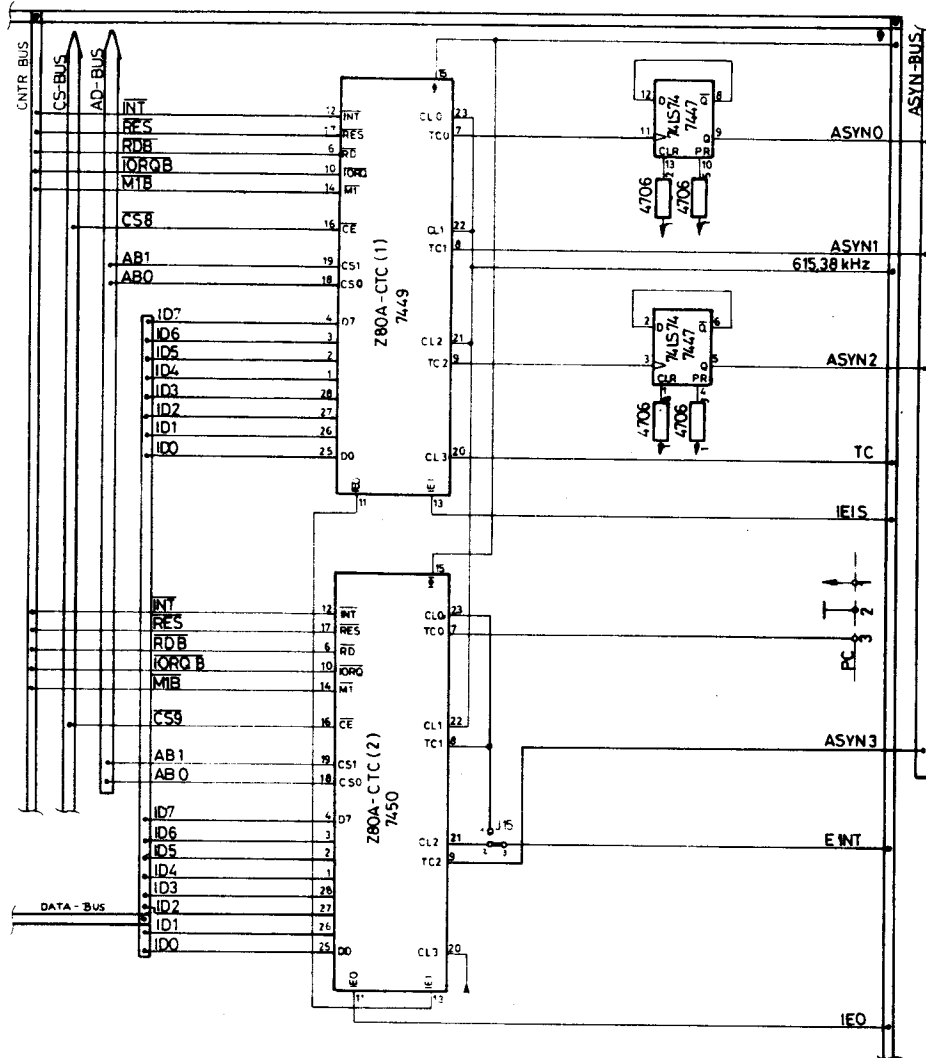
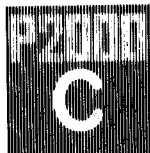

Figure 2.28 Circuit Diagram - CTC



Detailed Description and Servicing
Mainboard - Serial Interfaces

1

GENERAL

There are three fully duplexed serial channels.

- a) Terminal Interface
- b) Communication Interface
- c) Printer Interface

- a) and b) are controlled by a Z80A SIO
- c) is controlled by an 8251 USART

1.1

Z80A SIO - Z8440

The P2000C uses a Z80A SIO Serial Input/Output controller. The main features of the Z80A SIO are:

- two independent full-duplex channels, with separate control and status lines for modems or other devices.
- data rates of 0 to 800 Kbits per second, with a 4 MHz clock.
- asynchronous protocols: capable of handling complete messages in 5, 6, 7 or 8 bits per character. Includes variable stop bits and several clock-rate multipliers; break generation and detection; parity; and overrun and framing error detection.
- synchronous protocols: capable of handling complete bit- or byte-oriented messages in 5, 6, 7 or 8 bits per character, including IBM Bisync, SDLC, HDLC, CCITT-X-25 and others. Includes automatic CRC generation/checking; sync character and zero insertion/deletion; abort generation/detection and flag insertion.
- receiver data registers quadruply buffered, transmitter registers doubly buffered.
- highly sophisticated and flexible daisy-chain interrupt vectoring for interrupts without external logic.

Detailed Description and Servicing
Mainboard - Serial Interfaces



SIO Registers

Channel Selection

C/D	B/A	FUNCTION
0	0	CHANNEL A DATA
0	1	CHANNEL B DATA
1	0	CHANNEL A COMMANDS/STATUS
1	1	CHANNEL B COMMANDS/STATUS

Read Register 0

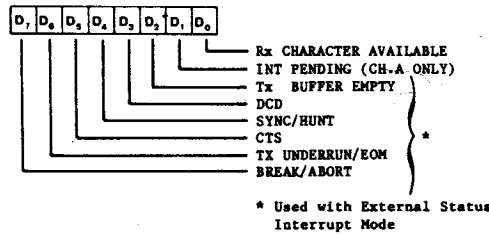

Read Register 1 (Used with Special Receive Condition Mode)

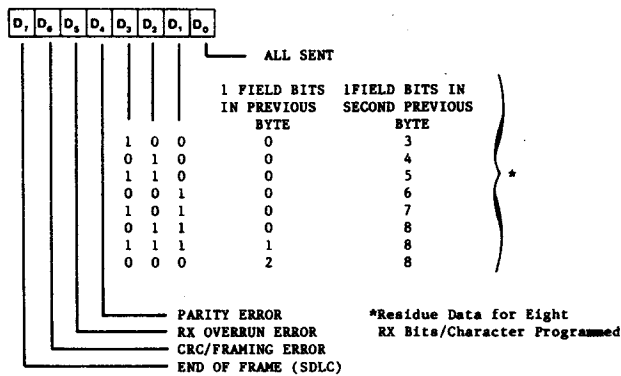

Read Register 2

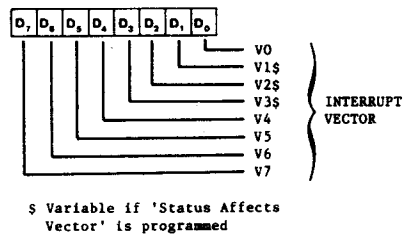
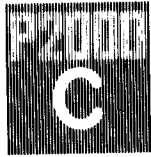

Figure 2.29 SIO Programming - Read Registers



Detailed Description and Servicing
Mainboard - Serial Interfaces

Write Register 0

D ₇	D ₆	D ₅	D ₄	D ₃	D ₂	D ₁	D ₀	
0	0	0	0	0	0	0	0	REGISTER 0
0	0	0	0	0	0	1	0	REGISTER 1
0	0	0	0	1	0	0	0	REGISTER 2
0	0	0	0	1	0	1	0	REGISTER 3
1	0	0	0	0	0	0	0	REGISTER 4
1	0	0	0	1	0	0	0	REGISTER 5
1	1	0	0	0	0	0	0	REGISTER 6
1	1	0	0	1	0	0	0	REGISTER 7
0	0	0	0	0	0	0	0	NULL CODE
0	0	0	1	0	0	0	0	SEND ABORT (SDLC)
0	1	0	0	0	0	0	0	RESET EXT/STATUS INTERRUPTS
0	1	0	1	0	0	0	0	CHANNEL RESET
1	0	0	0	0	0	0	0	ENABLE INT ON NEXT Rx CHARACTER
1	0	1	0	0	0	0	0	RESET Tx INT PENDING
1	1	0	0	0	0	0	0	ERROR RESET
1	1	1	0	0	0	0	0	RETURN FROM INT (CH A ONLY)
0	0	0	0	0	0	0	0	NULL CODE
0	1	0	0	0	0	0	0	RESET Rx CRC CHECKER
1	0	0	0	0	0	0	0	RESET Tx CRC GENERATOR
1	1	0	0	0	0	0	0	RESET Tx UNDERRUN/EOM LATCH

Write Register 1

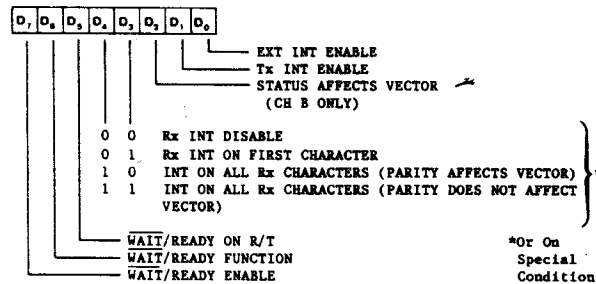

Status Affects Vector (D2 from WR1)

	V3	V2	V1	
CHANNEL B	0	0	0	CH B TRANSMIT BUFFER EMPTY
	0	0	1	CH B EXTERNAL STATUS CHANGE
	0	1	0	CH B RECEIVE CHARACTER AVAILABLE
	0	1	1	CH B SPECIAL CONDITION
CHANNEL A	0	0	0	CH A TRANSMIT BUFFER EMPTY
	0	0	1	CH A EXTERNAL STATUS CHANGE
	0	1	0	CH A RECEIVE CHARACTER AVAILABLE
	0	1	1	CH A SPECIAL CONDITION

If this mode is selected, the vector returned from an Interrupt Acknowledge Cycle will be according to this table. If this bit is 0, the fixed vector programmed in the Vector Register is returned.

Figure 2.30(i) SIO Programming - Write Registers

Detailed Description and Servicing
Mainboard - Serial Interfaces

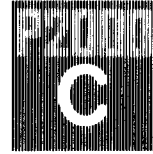

Write Register 2 (Ch. B Only)

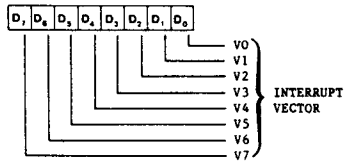

Write Register 3

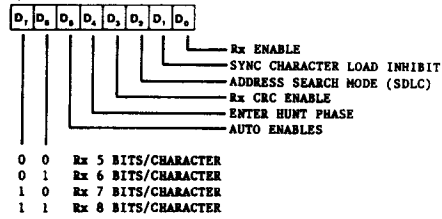

Write Register 4

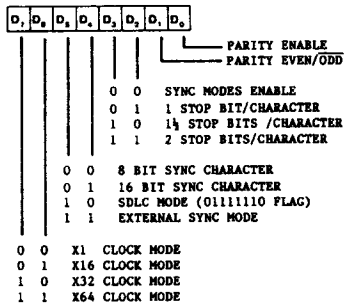

Write Register 5

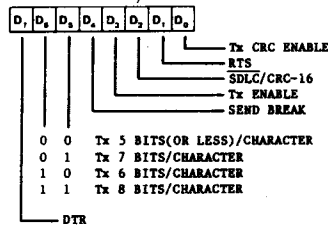

Write Register 6

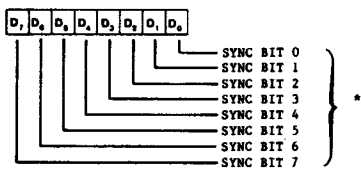

Write Register 7

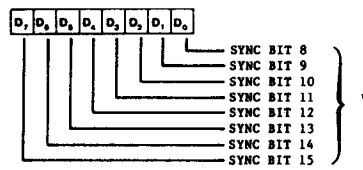
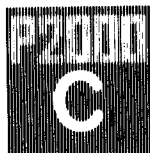

Figure 2.30(ii) SIO Programming - Write Registers



Detailed Description and Servicing Mainboard - Serial Interfaces

1.2

USART - 8251A

The P2000C uses an Intel 8251A as controller for the printer interface, as shown in figure 2.31.

The main features of the 8251A USART are:

- the 8251A has double-buffered data paths with separate I/O registers for control, status, Data In and Data Out. This simplifies control programming and minimizes CPU overhead.
- in asynchronous operations the receiver detects and handles 'break' automatically, relieving the CPU of this task.
- a refined Rx initialization procedure prevents the receiver from starting when in the 'break' state, thus suppressing unwanted interrupts from a disconnected USART.
- Tx Enable logic enhancement prevents a Tx disable command from halting transmission until all data previously written has been transmitted. The logic also prevents the transmitter from turning off in the middle of a word.
- synchronous baud rate from DC to 64K

Full details of the 8251A USART can be found in the Intel 8251A/S2657 Data Sheet.

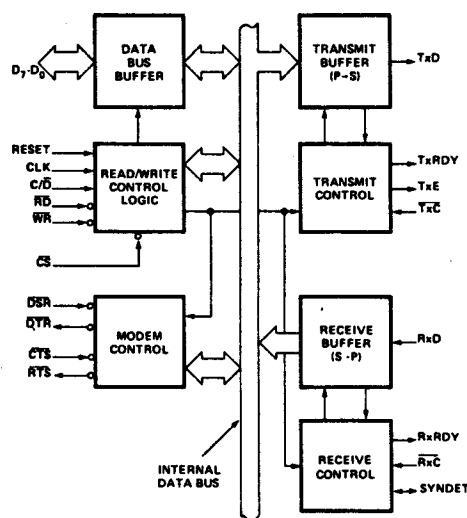
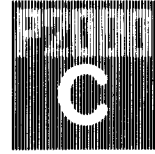

Figure 2.31 8251A USART - Block Diagram

Detailed Description and Servicing
Mainboard - Serial Interfaces



2

BLOCK DIAGRAM

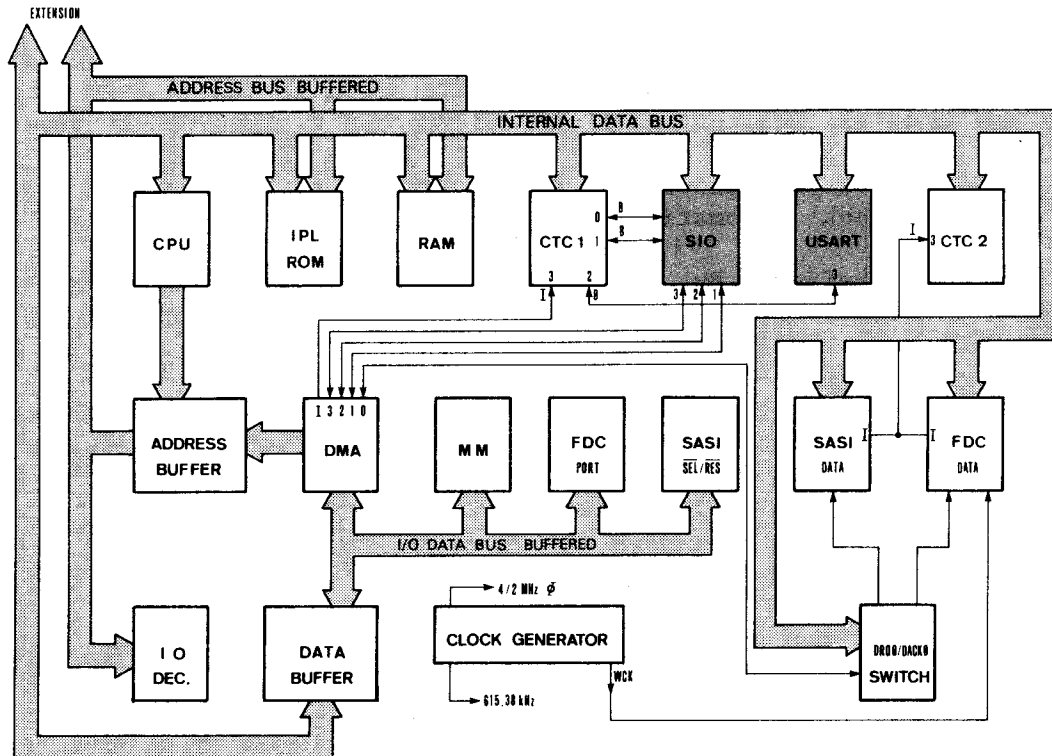
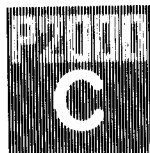

Figure 2.32 P2000C - Serial Interfaces Block Diagram



Detailed Description and Servicing
Mainboard - Serial Interfaces

3 CIRCUIT DESCRIPTIONS

3.1 General

The P2000C has three fully duplexed serial channels:

- a) Terminal Interface
- b) Communication Interface
- c) Printer Interface

a) and b) are controlled by the Z80 A SIO
c) is controlled by the 8251 USART

The transmit data of the Terminal interface (Video out) and the transmit and receive data of the communication interface can be moved to and from the SIO with CPU I/O commands or with DMA (Direct Memory Access).

It is possible for the SIO to initiate an interrupt.

The printer interface is used without interrupt and without DMA.

The SIO and the USART are able to work synchronously or asynchronously. Complicated synchronous protocols (e.g. SDLC and HDLC) can only be handled with the SIO.

3.2 Baudrate Selection

All serial channels can be supplied by the internal baudrate generators (CTC's). The real baudrate is calculated as follows:

$$FBd = \frac{615380}{t_{CTC} \times t_{FF} \times t_{USART}}$$

where:

- FBd = clock frequency in Hz
- 615380 = basic frequency, in Hz. All other clocks are derived from it.
- tCTC = division factor of the particular CTC channel
- tFF = division factor of 2 or 1, depending on whether or not a flip-flop is added to the CTC channel, for forming the duty cycle.
tFF = 2 for terminal interface
tFF = 1 for communication interface
- tUSART = internal division factor of 1,16 or 64 in the USART or SIO, and is selectable by software.

Detailed Description and Servicing
Mainboard - Serial Interfaces

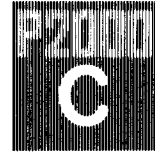

Example: The printer interface is required to work at 19200 Bd.

With:

tCTC = 1

tFF = 2

tUSART=16

$$\boxed{\text{FBd} = \frac{615380}{1 \times 2 \times 16} = 19230 = 19200 + 0.16\%}$$

Because of the internal circuits of the SIO and the USART the tUSART should not be 1, to ensure correct operation. (The only exception is the communication interface when used in a synchronous mode and with an external clock).

3.2.1 MAXIMUM BAUDRATES

The maximum baudrates for the P2000C Serial Interfaces are as follows:

- For the terminal and the printer interfaces 19,200 Bd
- For the communication interface
 - (internally clocked) 38,400 Bd
 - (externally clocked) 500,000 Bd

(500,000 Bd is the limit given in the SIO data sheet.
As the SIO clock is switched between 4 and 2 MHz baudrates, limit calculations must be made using the 2 MHz value.)

3.3 Terminal Interface

The terminal interface is controlled by the SIO (item 7441), channel B. (I/O Address 28H - 2BH).

Transmit data (video output) also can be sent via DMA Channel 3. (W/RDYB-N must be programmed for transmit data).

Receive data (keyboard input) will be fetched only by CPU.

When using an external terminal, the internal terminal must be disconnected. If optional drivers (items 7406/7404) are fitted in assemblies with PRINT number up to .2 (ASSY No up to .1) (see 3.1 0-2) the print tracks between driver and SIO must be cut (pins 3, 6 & 8) to avoid signal conflict if the internal terminal is used. When using synchronous modems the drivers must be fitted. A gate of item 7404 is used for the DSR signal.

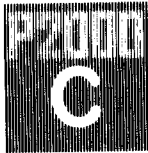

Detailed Description and Servicing
Mainboard - Serial Interfaces

3.3.1 BAUDRATE GENERATOR

The terminal baudrate generator is CTC 1 (Item 7449). Channel 0 output TCO is used, via D-FF (Item 7447-2), to produce ASYN 0. (tFF = 2)

Note: An external clock can also be used from the terminal board, via a jumper.

3.4 Communication Interface

It is controlled by the SIO (item 7441) channel A. (I/O address 28H - 2BH). *28 3.2 6-4 (2914)*

There is only one W/RDYA-N output available for controlling channel A of the SIO. To control both channels (transmit and receive) via DMA the following actions are carried out:

One SIO channel is directly connected to the DMA via W/RDYA-N (DMA channel 2). As soon as the other SIO channel (e.g., transmit data) issues an interrupt, which indicates that a data transfer is necessary, the CPU sets an I/O write to address 10H or 11H during the interrupt routine. A flip-flop is then set, demanding the DMA channel 1 to do a data transfer. The DMA chip must be correctly programmed beforehand.

Which DMA channel (1 or 2) handles transmitted or received data depends on the programming of the SIO and the DMA.

3.4.1 BAUDRATE GENERATOR

Transmitter Clock

The communication transmitter uses ECLK1 - PSE 2 pin 15. This signal is normally supported by a synchronous modem

Receiver Clock

The communication receiver uses ECLK2 - PSE 2 pin 17. This signal is also supported by a synchronous modem.

Detailed Description and Servicing
Mainboard - Serial Interfaces

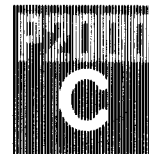

Note: Nearly all combinations of clock signals (two External Clock connections, ASYN 3 or ASYN 1) are possible on the transmitter and receiver clock inputs, using jumpers J10, J12 and J13. Full details are shown in table 2.16.

To use the Communications channel in an asynchronous mode, connect ECLK0 (PSE 2 pin 24) to ECLK1 & 2 (PSE 2 pins 15 & 17). In this case Baud rate generator ASYN1 determines the clock frequency for both the receiver and the transmitter.

Channel 2 of CTC 2 is used for external interrupt input for IEEE (P2012), but can be used to produce ASYN 3.

3.4.2 JUMPER J 20

This jumper routes the DSR (data set ready) signal to the SYNC inputs of the SIO. The normal condition is with pins 2-4 & 3-4 short circuited, routing DSR to the SYNCB input of the SIO.

3.5 Printer Interface

The printer interface is controlled by the USART.
(I/O address 14H - 15H).

On this interface it is not possible to give an interrupt or to work through DMA.

3.5.1 BAUDRATE GENERATOR

The printer interface uses CTC 1 (Item 7449) for both the transmitter and receiver clocks. Channel 2 output TC2 is used, via D-FF (Item 7447-1), to produce ASYN 2. (tFF = 2)

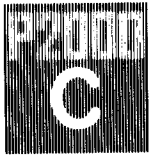

Detailed Description and Servicing
Mainboard - Serial Interfaces

13-11

3.6 Connection - Mainboard to Terminalboard

As the connection between the Mainboard and the Terminalboard is internal to the P2000C cabinet, the RS 232 drivers and receivers can be omitted and the system will work directly at TTL levels. If the Mainboard is used with an external terminal or the Terminalboard used as a stand alone terminal, the RS 232 components and the D-device plug can be implemented.

3.7 Jumpers

3.7.1 D-DEVICE PLUGS

The pin allocation on devices used with the P2000C may differ. To avoid the necessity of cross over of external cables, all logical signal pairs on the D-device plugs are reversible by jumper. These signal pairs are:

RxD - TxD
CTS - RTS
DTR - DSR

The jumpers involved are J1 through J9 and full details of their use are given in table 2.16. Connections marked "*" represent the standard setting as shown in figure 2.33. Pin 1 of the connectors PSE1, PSE2 and PSE3 are connected to the connector housing.

3.7.2 BAUDRATE SELECTION

Clock selection for channels A & B of the SIO is controlled by jumpers J10 through J13. The standard configuration of these four jumpers gives the following baudrate selections, where channel A is connected as for a Standard Synchronous Modem:

Channel A TxC = ECLK 1
Channel A RxC = ECLK 2 (J12 = 3 - 4 / J10 = 1 - 2)
Channel B RxTxC = ASYN 0 (J11 = 1 - 3)

Full details of the baudrate clock selection jumpers are given in table 2.16. Connections marked "*" represent the standard setting as shown in figure 2.33.

Detailed Description and Servicing
Mainboard - Serial Interfaces

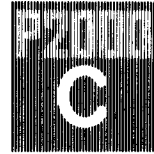

Table 2.16 - Serial Interface Jumpers

PRINTER CONNECTOR (PSE 3)

J1			J2			J3		
PIN	RxD	TxD	PIN	CTS	RTS	PIN	DSR	DTR
2	3-4*	2-4	4	5-6	4-6	6	4-2	1-2*
3	3-1	2-1*	5	5-3	4-3*	20	4-3*	1-3
			perm 1-2* - (pin 2 to +12V)					

COMMUNICATION CONNECTOR (PSE 2)

J4			J5			J6		
PIN	RxD	TxD	PIN	CTS	RTS	PIN	DCD	DTR
2	3-4	2-4*	4	5-6	4-6*	8	4-2*	1-2
3	3-1*	2-1	5	5-3*	4-3	20	4-3	1-3*
			(see note below)					

TERMINAL CONNECTOR (PSE 1)

J7			J8			J9		
PIN	RxD	TxD	PIN	CTS	RTS	PIN	DSR	DTR
2	3-4*	2-4	4	5-6*	4-6	6	4-2	1-2*
3	3-1	2-1*	5	5-3	4-3*	20	4-3*	1-3
			(see note below)					

- Notes: 1) A permanent CTS can be arranged by routing +12V (on pin 1) to pin 5, via the jumpers.
2) The connector PSE 1 is not fitted to the board.

BAUDRATE SELECTION

	TxC A	RxC A	RxTx C B
ASYN 1	J13/1-2	J13/1-2 J12/1-3	
ASYN 3	not possible	J12/5-3	
EXT 1 PIN 15	J12/1-2*	J12/2-4 & 3-4	
EXT 2 PIN 17	J10/1-2 J12/4-3 & 3-1	J10/1-2* J12/4-3*	
EXT 3 PIN 25 (see note below)			
ASYN 0			J11/1-3*
TERM BOARD			J11/2-3

Note: In the new layout for the Mainboard, ASYN 3 is routed to pin 25 of PSE 2 as EXT 3. It is therefore possible to drive transmitter and receiver at different baud rates for asynchronous operation via pins 15 (Tx) and 17 (Rx) of PSE 2.



Detailed Description and Servicing
Mainboard - Serial Interfaces

3.7.3 JUMPERS - PHYSICAL CONNECTIONS

Figure 2.33 shows the physical connections for the standard settings of the serial interface jumpers. The pin numbering convention, as used in any drawings or diagrams, is shown. These numbers do not appear on the printed circuit board.

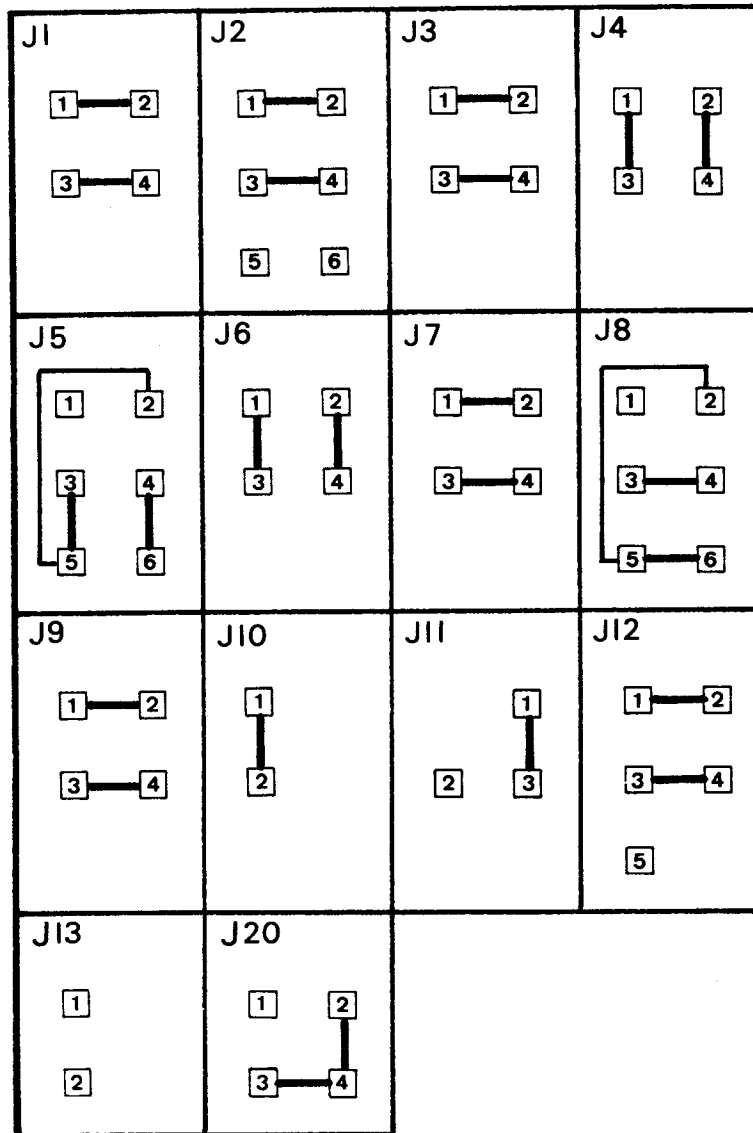
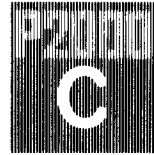

Figure 2.33 Serial Interface Jumpers

13-14

Detailed Description and Servicing
Mainboard - Serial Interfaces



THIS PAGE INTENTIONALLY BLANK



Detailed Description and Servicing
Mainboard - Bus Extension

1

GENERAL

It is possible to extend the capabilities of the P2000C with the use of one additional board. On the Mainboard, buffered outputs are available via a 120 way connector. The bi-directional data bus allows one low power shottky load (50pF). Pin connections for the Bus Extension are shown in table 2.17.

Table 2.17 - Bus Extension

PIN	SIGNAL	DIRECTION	PIN	SIGNAL	DIRECTION
01	8 MHz B	OUT	53	IORQB-N	OUT
03	CLOCK	OUT	55	AB15	OUT
05	2 MHz B	OUT	57	AB14	OUT
07	EXTEN-N	OUT	59	AB13	OUT
09	EXTDIS-N	IN	61	AB12	OUT
11	NC	-	63	AB11	OUT
13	EINT-N	IN	65	AB10	OUT
15	NC	-	67	AB9	OUT
17	NC	-	69	AB8	OUT
19	HALTB-N	IN	71	AB7	OUT
21	WAIT-N	IN	73	AB6	OUT
23	RESET-N	IN	75	AB5	OUT
25	NMI-N	IN	77	AB4	OUT
27	INT-N	IN	79	AB3	OUT
29	NC	-	81	AB2	OUT
31	IEO-N	OUT	83	AB1	OUT
33	NC	-	85	AB0	OUT
35	BAO-N	OUT	87	D7	IN/OUT
37	NC	-	89	D6	IN/OUT
39	BUSAK-N	OUT	91	D5	IN/OUT
41	BUSRQ-N	IN	93	D4	IN/OUT
43	WRB-N	OUT	95	D3	IN/OUT
45	RDB-N	OUT	97	D2	IN/OUT
47	RFSHB-N	OUT	99	D1	IN/OUT
49	MLB-N	OUT	101	D0	IN/OUT
51	MREQB-N	OUT			

Pins 107 - 110 -12 V

Pins 113 - 116 +12 V

Pins 117 - 120 + 5 V

Pins 2, 4, 6 ... 106, 103, 105, 111 & 112 - GND

14-2

Detailed Description and Servicing
Mainboard - Bus Extension



THIS PAGE INTENTIONALLY BLANK

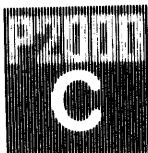

Detailed Description and Servicing
Terminalboard - Introduction

1

GENERAL

The Terminalboard, which is connected to the Mainboard by a serial interface (USART 8251 A), carries out the following functions:

- control of a b/w monitor
- scanning of the keyboard
- control of the beeper

The CPU and CRTC work synchronously to ensure a rapid update of the screen image. Controlled by the character clock, the CPU and CRTC manage the address bus and the data bus alternately. The CPU has unlimited access to the video refresh RAM, without disturbing the video image (Interleaving mode).

Two banks with 16 kByte RAM and 8 kByte ROM are reserved for storage.

There are three different kinds of image representation:

- alphanumeric with 5 attributes
- medium resolution graphics in 4 grey shades, with alphanumeric representation
- high resolution graphics with alphanumeric representation

Some functions (graphic, keyboard, attribute treatment) can be controlled via an I/O port. The keyboard is scanned by video refresh addresses and, if a key is depressed, it gives a strobe to the light pen input of the CRTC. The decoded key address is stored in the light pen register. The Terminalboard can also be used as an independent data terminal (with graphics) by the use of an optional V24 interface.

Detailed Description and Servicing
Terminalboard - Introduction

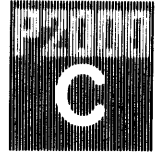

THIS PAGE INTENTIONALLY BLANK



Detailed Description and Servicing
Terminalboard - CPU

1 GENERAL

This is the same device as used on the Mainboard and general comments dealing with the Z80 CPU can be found in that section.

2 BLOCK DIAGRAM

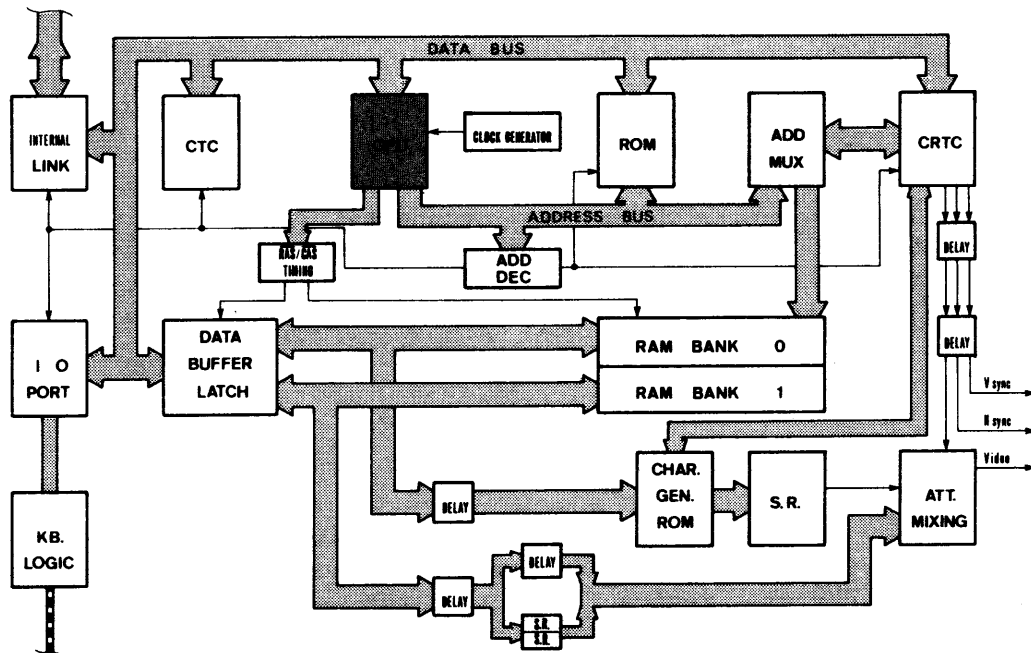
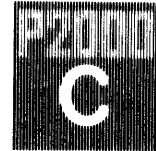

Figure 3.1 P2000C - CPU Block Diagram

Detailed Description and Servicing
Terminalboard - CPU



3 CIRCUIT DESCRIPTION

The Z80A CPU (item 7408) is synchronized to the CRTC by using the clock signal (3.072 MHz), enabling the CPU to carry out processing without wait cycles. An access to the memory is only possible at every second cycle (interleaving mode). The internal (CPU) data and address busses are connected to the system busses.

3.1 Address Decoding

The addresses that are decoded are as follows:

- A15 and A14 define 16 kByte memory blocks
- A7 and A6 are decoded for chip enable and I/O port
- A0 and A1 are routed:
 - to the CRTC for register select and read/write
 - to the CTC for channel select (0 and 1) and
 - to the USART for C/D (control/data indication)

3.2 Reset

The Reset, which is connected to the CPU via two Schmitt-triggers (item 7479 - 7480 in new layout), is either created by a CR-network as power-on Reset, or comes from the distribution board.

3.3 Interrupt Mode

The CTC, which works in interrupt mode 2, is connected to the interrupt line. In interrupt mode 2, the interrupting peripheral device selects the starting address of the interrupt service routine by placing an 8-bit address vector on the data bus during the interrupt acknowledge cycle.



Detailed Description and Servicing
Terminalboard - CPU

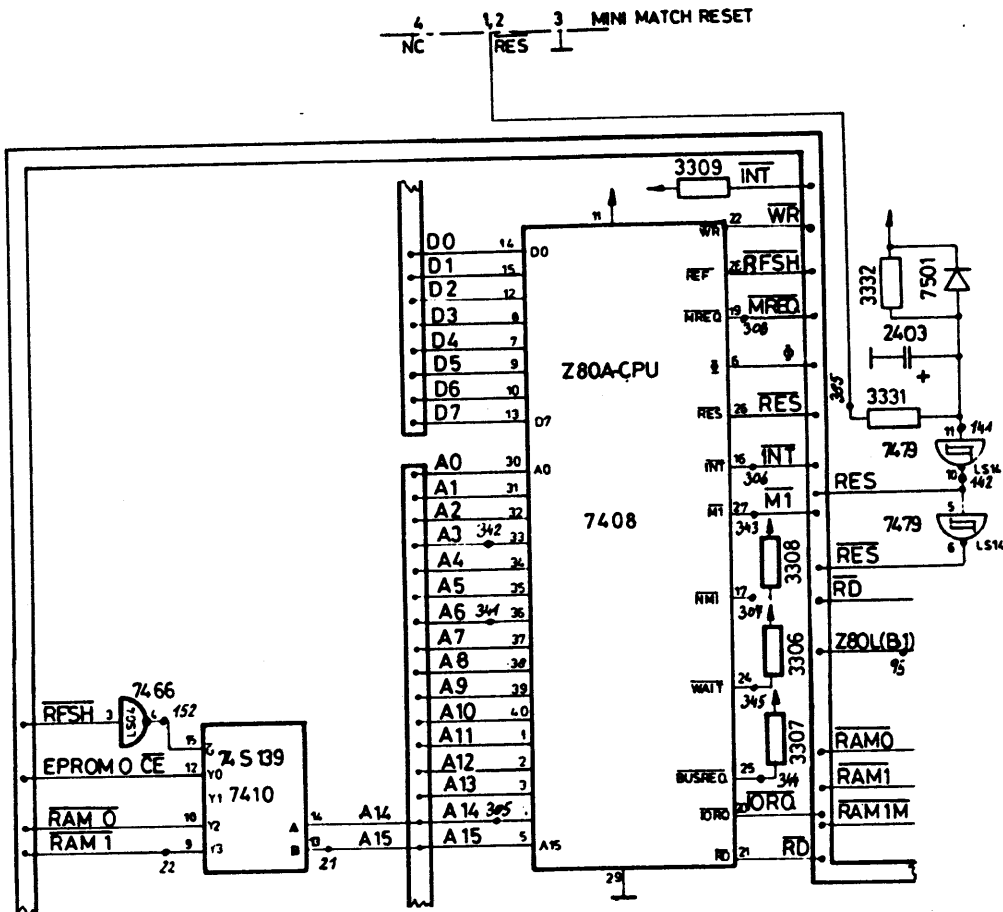
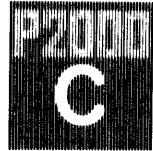
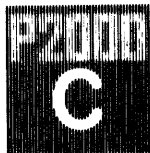

Figure 3.2 Circuit Diagram - CPU

Detailed Description and Servicing
Terminalboard - CPU



THIS PAGE INTENTIONALLY BLANK



Detailed Description and Servicing
Terminalboard - CRT Controller

1

GENERAL

The CRT Controller (CRTC) is an MC 6845, which generates all the signals required for controlling a monitor. The video refresh addresses given by the CRTC are only used to control the alphanumeric characters and the attributes. If RAM Bank1 is used as a graphic memory the addresses are created by an extra counter, synchronised to the MC 6845.

Full details of the MC 6845 CRT Controller can be found in the relevant data sheets.

The CRTC functional block diagram is shown below:

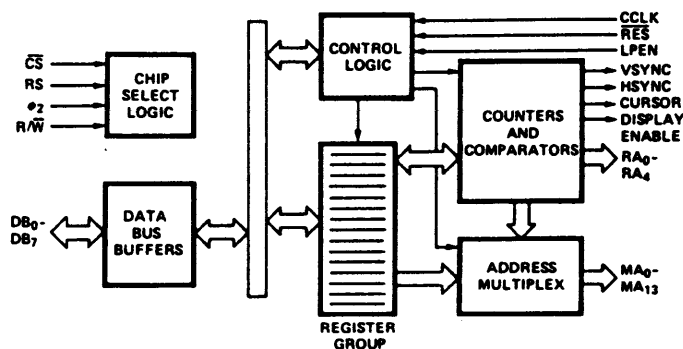
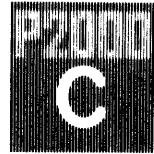

Figure 3.2 CRTC MC 6845 - Block Diagram

Detailed Description and Servicing
Terminalboard - CRT Controller



2

BLOCK DIAGRAM

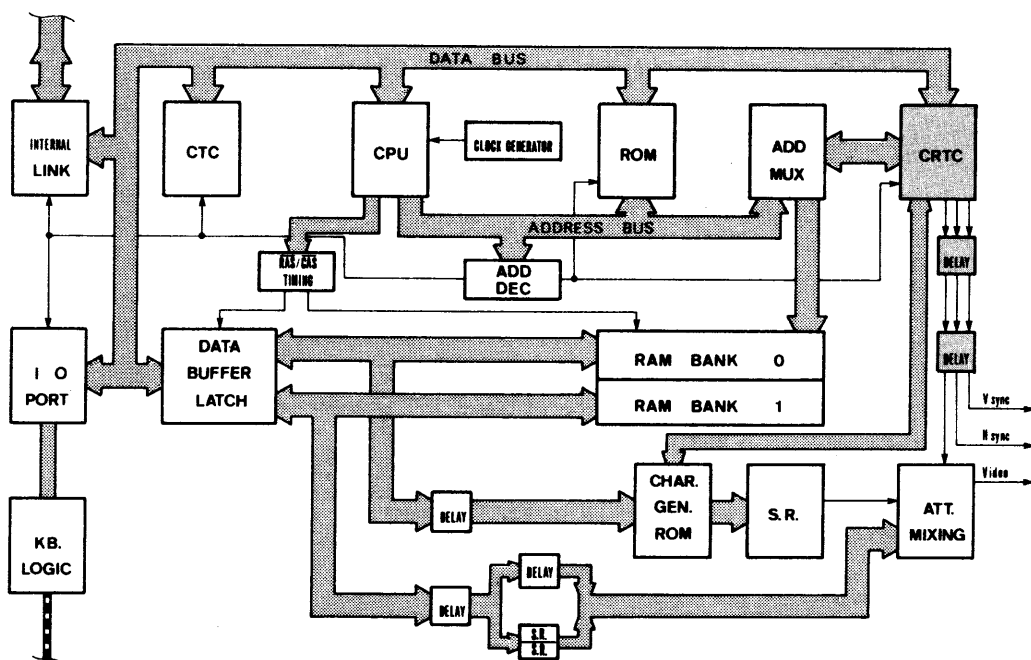
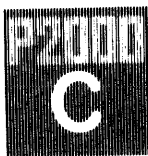

Figure 3.3 P2000C - CRTC Block Diagram



Detailed Description and Servicing
Terminalboard - CRT Controller

3

CIRCUIT DESCRIPTION

If the CRTC (item 7412) address lines are routed to the RAM, an 8k Byte video memory is created. The application of +5V (by jumper) to the video memory selects a loop of either 4k Byte (5V on MA11) or 2k Byte (5V on MA12), where hardware scroll is possible. The rest of the video memory is free for the CPU.

The different screen sizes for alphanumeric or graphic displays are programmable.

The video refresh addresses are fed, via a multiplexer, to the RAM's. The read out data is first stored in latches and then fed to the character generator (ROM) as addresses. The lower 4 addresses for the ROM are kept ready as row addresses by the CRTC.

Data from the character generator ROM is read into the shift register and shifted out by the dot clock. After this the attributes, the cursor and the CRTC signal Display Enable (DE) are added. The cursor and the DE signal, together with the Vertical and Horizontal sync signals, are delayed twice (items 7452/7454) to ensure that they are present at the output simultaneously with the data. This delay is not required at the row addresses.

The character clock is used for timing. The light pen input and the light pen register are used to scan the keyboard

3.1

Communication between Z80 and 6845

The inverted IORQ-N signal is used as the system clock for the CRTC. A0 and A1 of the CPU are used for register selection and R/W selection. It ensures that the R/W signal is present at the same time as the address, i.e., ahead of the rising edge of the system clock. It leads to the following address reservations:

\$ 80 write address register
\$ 81 write register
\$ 82 read status register
\$ 83 read register

Detailed Description and Servicing
Terminalboard - CRT Controller

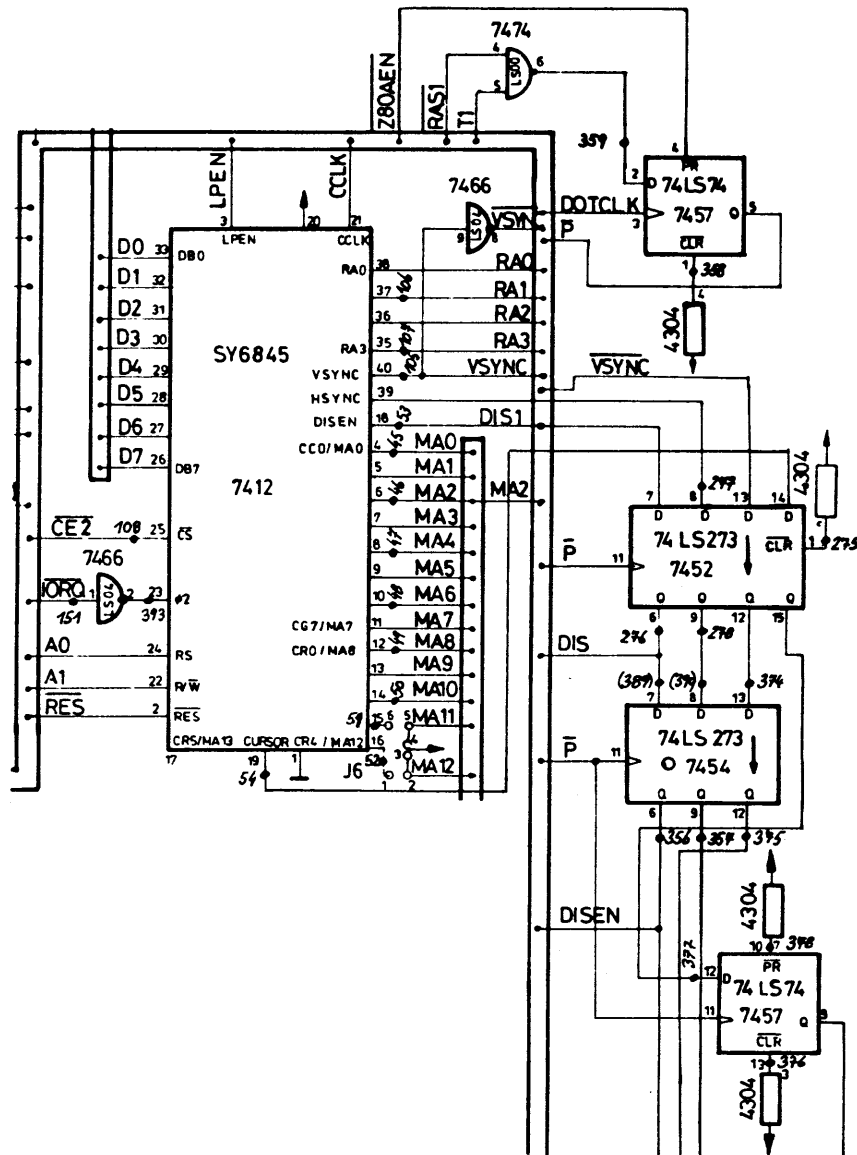
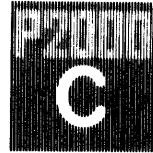
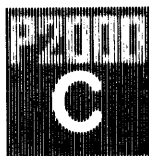

Figure 3.4 Circuit Diagram - CRT Controller



Detailed Description and Servicing
Terminalboard - Timing

1

GENERAL

All frequencies on the Terminal board are derived from the dot clock (12.288 MHz), which shifts the dots out of the shift register. This frequency is generated by a quartz crystal controlled Colpitts oscillator.

Detailed Description and Servicing
Terminalboard - Timing

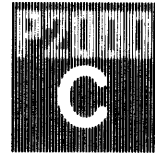

2

BLOCK DIAGRAM

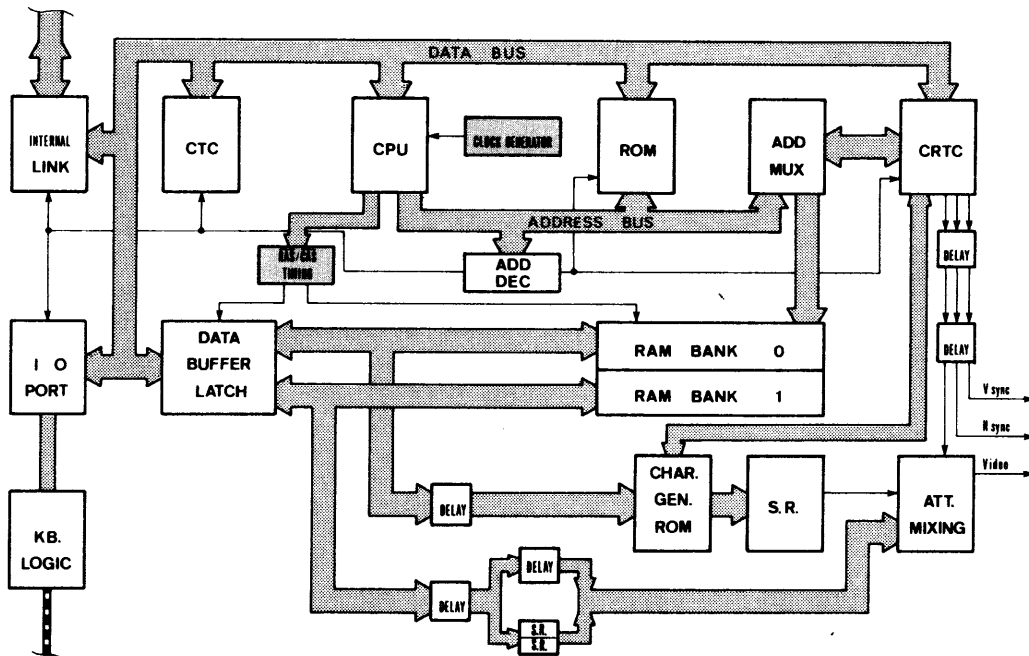
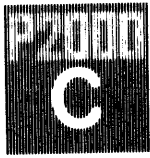

Figure 3.5 P2000C - Timing Block Diagram



Detailed Description and Servicing
Terminalboard - Timing

3

CIRCUIT DESCRIPTION

The RAS-N signal, given by 'dot clock/4' via item 7458 - QB13, is applied to the RAM's continuously.

The character clock for the CRTC is derived from 'dot clock/8' via item 7458 - QC/12.

The Z80 address enable (Z80AEN) is produced via a flip flop (item 7463). It is delayed for 162 ns to the character clock. The RAS-N signal releases a read or write signal (alternating the addresses of the CPU or CRTC) in the dynamic memories. This RAS-N signal always appears in the second half of the Z80AEN state, allowing the particular addresses to stabilize.

The MUX-N signal (used to switch over the row addresses to the column addresses), the CPU clock and the CAS-N signal (clock for the CPU and column address strobe for the dynamic memories) are derived from the RAS-N signal by a delay line (item 5301).

3.1

Delay Line

The delay line is a network containing three inductors and two capacitors, as shown in the following diagram:

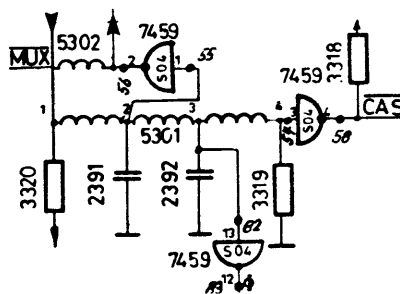

The delay at the outputs between: RAS-N and MUX-N is 20 ns
 RAS-N and CLOCK is 32 ns
 RAS-N and CAS-N is 50 ns

Detailed Description and Servicing
Terminalboard - Timing

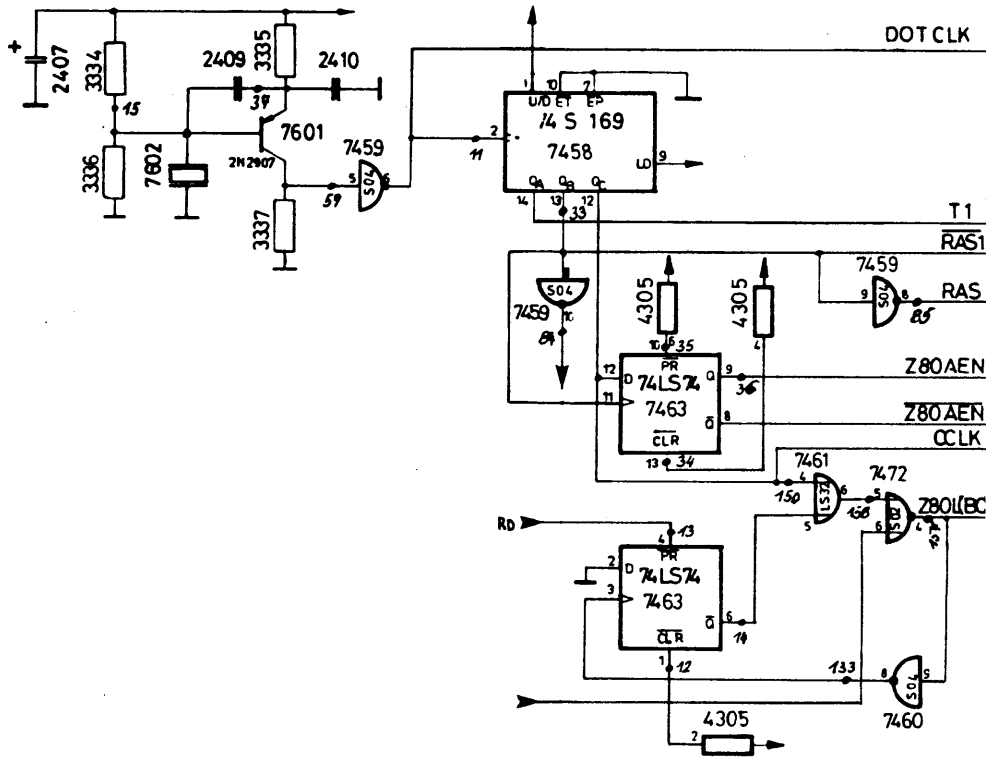
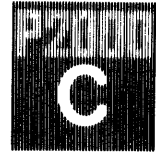

Figure 3.6 Circuit Diagram - Timing



Detailed Description and Servicing
Terminalboard - RAM Banks

1

GENERAL

The devices used for the two RAM Banks on the Terminalboard are uPD 416C-5's. Each Bank consists of 8 of these 16K 1-bit RAM's:

- Items 7433 to 7440 are used for RAM Bank0, the Video Refresh Memory.
- Items 7425 to 7432 are used for RAM Bank1, the Attribute Memory.

Full details of the uPD 416C-5 can be found in the relevant NEC Data Sheets

Detailed Description and Servicing
Terminalboard - RAM Banks

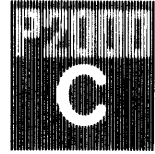

2

BLOCK DIAGRAM

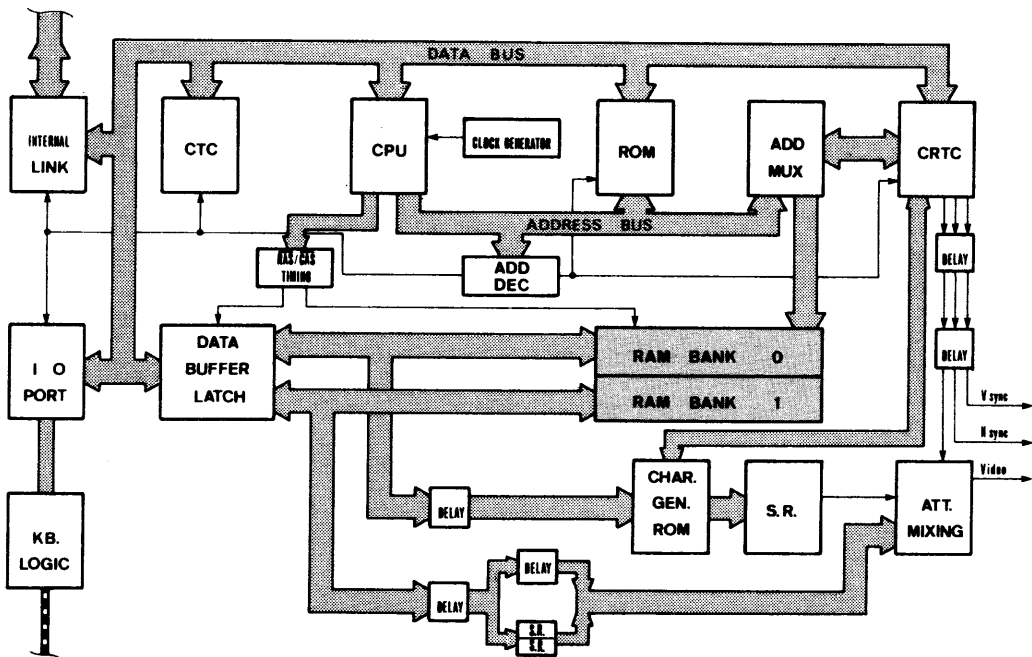
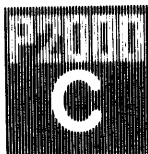

Figure 3.7 P2000C - RAM Banks Block Diagram



Detailed Description and Servicing
Terminalboard - RAM Banks

3 CIRCUIT DESCRIPTION

3.1 RAM Bank0 - Video Refresh Memory

The 16 Kbyte RAM Bank0 is divided into two parts. The upper part (the higher addresses) contains the video refresh memory for the alphanumeric presentation. The lower part contains the RAM memory of the CPU (buffer, downloaded Initial Program Load, stack etc.,).

The size of the video refresh memory is variable, and may be set to 2, 4 or 8 Kbytes. The selection of the size of the video memory is carried out with jumper J6 (on the Terminalboard). The CPU uses the remaining memory, i.e., 14, 12 or 8 Kbytes.

3.1.1 JUMPER J6

[6]	[5]---	MA11	Links on jumper J6 are short circuited as indicated below, to give the sizes of video refresh memory shown:
	[4]		
	----	5V	
	[3]		
[1]	[2]---	MA12	5-4; 3-2 for Upper 2K
			5-6; 3-2 for Upper 4K
			5-6; 1-2 for Upper 8K

3.2 RAM Bank1 - Attribute Memory

The 16 kByte RAM Bank1 is used either as the attribute memory or as the graphics memory. When using RAM Bank1 as the attribute memory the free area, depending on the selected size of the video refresh memory, can also be used by the CPU. No opcode fetch is allowed.

3.2.1 ATTRIBUTES

Only the lower five bits of each word are used to store attribute information. The significance of each bit is as follows:

- Bit 0 = Underline
- Bit 1 = Blink
- Bit 2 = Inverse representation
- Bit 3 = Brightness 0 (MSB)
- Bit 4 = Brightness 1 (LSB)

Detailed Description and Servicing
Terminalboard - RAM Banks

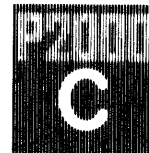

When handling attributes there are three possible modes, selectable via an output port:

- Z80 RD/WR : Normal write/read access to RAM Bank1 by the CPU
- BLOCK MOVE : Using the Z80A CPU LDIR instruction, a block move operation in Bank0 will automatically move the corresponding attributes to Bank1.
- BLOCK WRITE: First, the attribute (or combination of attributes) must be written to RAM Bank1. It must then be read out (by software) and latched (in item 7447). On all following write actions (of character information) to RAM Bank0 it is written to the corresponding location in RAM Bank1. If another attribute is read out from RAM Bank1 this new attribute is repeated.

	Z80 RD/WR	BLOCK MOVE	BLOCK WRITE
OUT3	0	1	1
OUT4	1	0	1

3.2.2 GRAPHIC MEMORY

If RAM Bank1 is used for graphic memory there are two possible methods:

- HIGH resolution graphic with 512 x 252 dots
- MEDIUM resolution graphic with 256 x 252 dots and 4 grey shades.

At both resolutions a mixing with alphanumeric characters without attributes is possible.



Detailed Description and Servicing
Terminalboard - RAM Banks

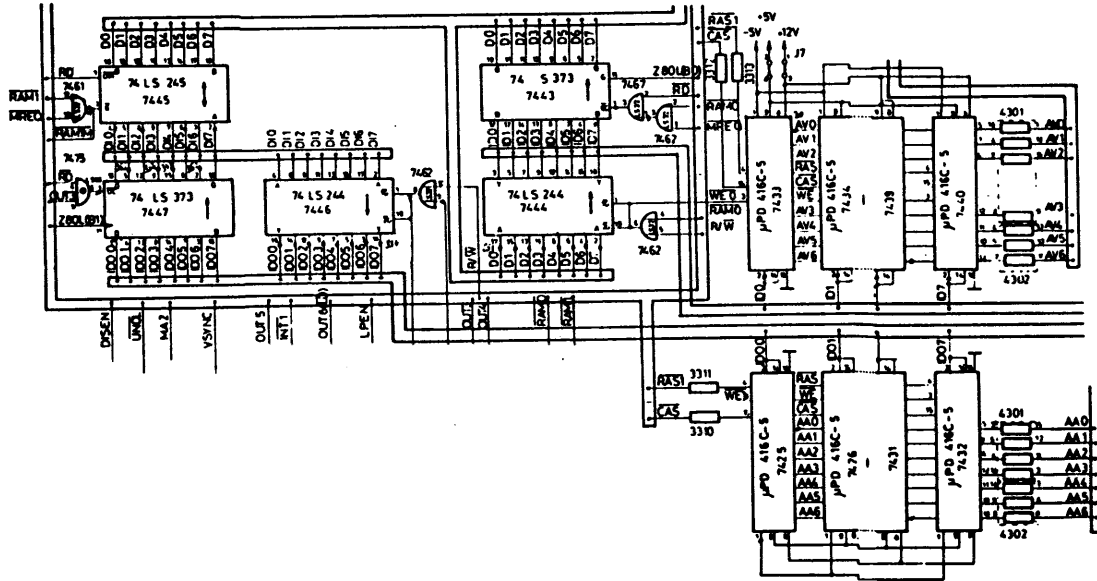
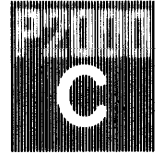

Figure 3.8 Circuit Diagram - RAM Banks

Detailed Description and Servicing
Terminalboard - RAM Banks



THIS PAGE INTENTIONALLY BLANK



Detailed Description and Servicing
Terminalboard - Address Multiplexer

1 GENERAL

Eight 74 LS 257's are used as the address multiplexer. With this, the addresses of the CPU (A0 - A13) and CRTIC (MA0 - MA12) are used alternately to address RAM Bank0 and RAM Bank1 (7-bit addresses).

2 BLOCK DIAGRAM

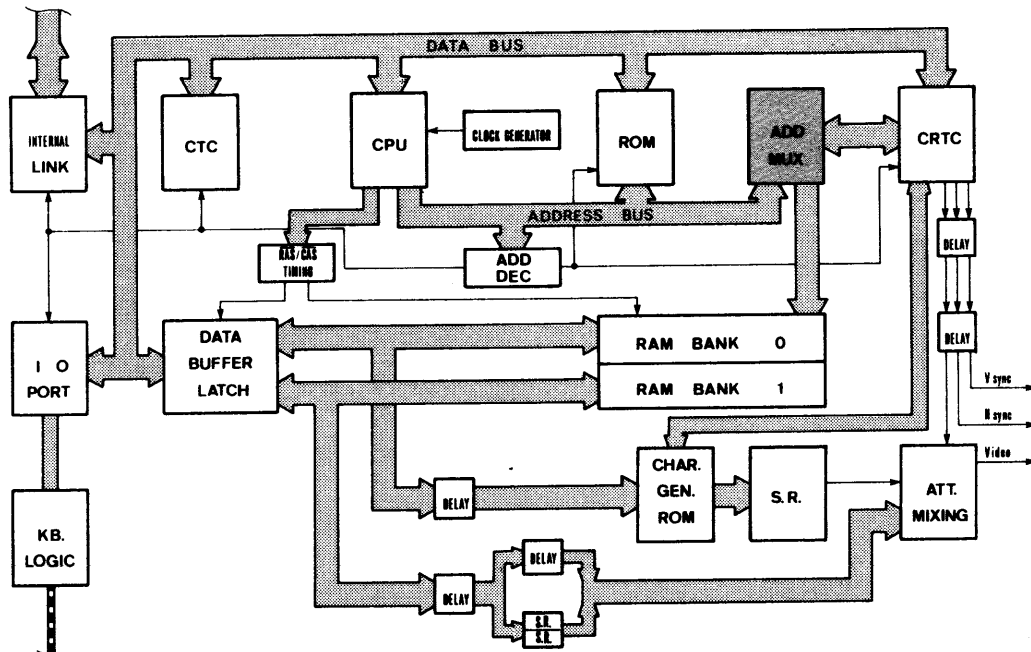
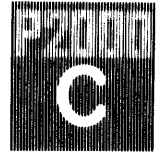

Figure 3.9 P2000C - Address Multiplexer Block Diagram

Detailed Description and Servicing
Terminalboard - Address Multiplexer



3

CIRCUIT DESCRIPTION

Two pairs of multiplexers are connected to the address bus of each RAM Bank. The outputs, originating from the CPU and the CRTC, are switched alternately and they are connected with the RAM Address bus. This switch over is done by using the Z80AEN signal. The MUX-N signal is used to switch over between the lower and higher bits (row address and column address). When the RAS-N signal becomes active (falling edge) the lower addresses are applied to the RAM, so all rows of dynamic RAMs can be refreshed.

At RAM Bank1 the addresses of the CRTC are routed via transparent programmable counters to the multiplexer. For alphanumeric representation with attributes the counter is switched so that the supplied addresses appear directly on the outputs (programmable counter 74 LS 197). For graphic mode the counter is switched to count the Z80AEN frequency independent of the data input, if the display is enabled. In this way the whole memory area (16K) of RAM Bank1 is read out continuously. The switch over is done by OUT0.



Detailed Description and Servicing
Terminalboard - Address Multiplexer

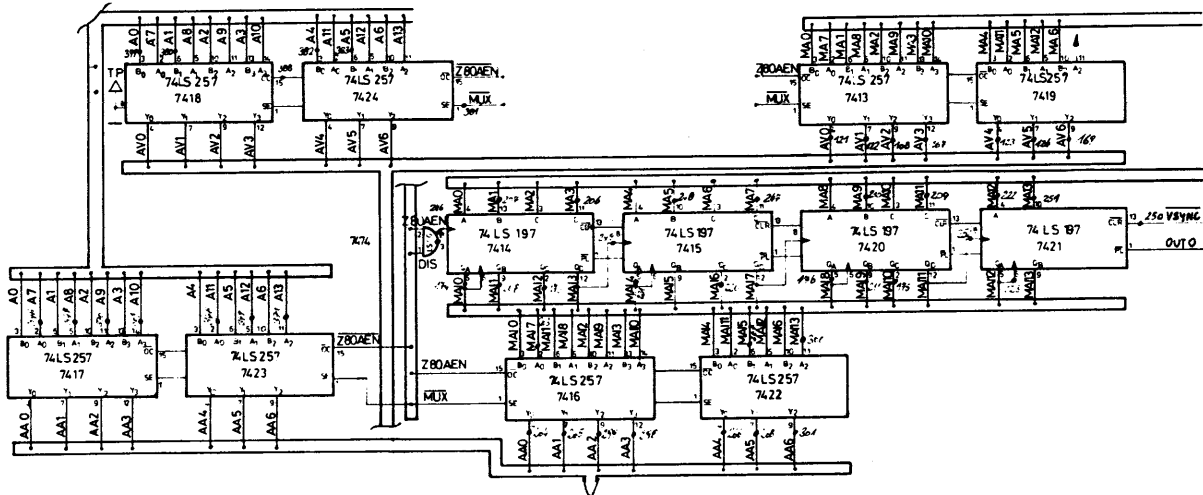
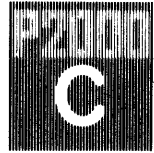

Figure 3.10 Circuit Diagram - Address Multiplexer

Detailed Description and Servicing
Terminalboard - Address Multiplexer



THIS PAGE INTENTIONALLY BLANK



Detailed Description and Servicing
Terminalboard - Data Buffer

1 GENERAL

1.1 Temporary Storage

Because of the alternating access to the RAM by CPU and CRTIC (162 ns RAS-CPU, 162 ns precharge time, 162 ns RAS-CRTIC, 162 ns precharge time) it is necessary to temporarily store data which will be read by the CPU. This does not apply to data which is written to the memory by the CPU, which must only be buffered.

2 BLOCK DIAGRAM

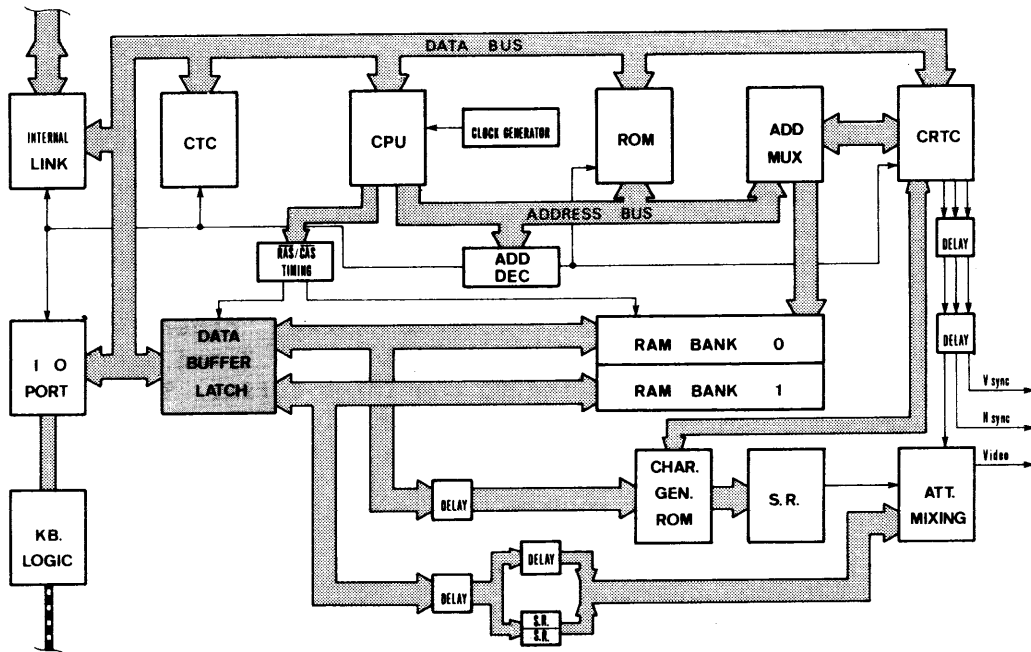
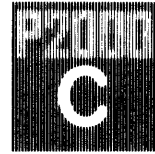

Figure 3.11 P2000C - Data Buffers Block Diagram

Detailed Description and Servicing
Terminalboard - Data Buffer



3 CIRCUIT DESCRIPTION

3.1 Read

For reading the data from the memory, a latch signal has to be created. Both RAM Banks are connected to data buffers (Bank0 74 LS 244 - item 7444 and Bank1 74 LS 244 - item 7446) and data output latches (RAM Bank0 74 S 373 - item 7443 and RAM Bank1 74 LS 373 - item 7447). To switch between different attribute modes (normal, block move and block write), a bus transceiver is added to RAM Bank1 (74 LS 245 - item 7445). Every latch (temporary memory) must have a discrete latch signal.

3.1.1 Z80 LATCH SIGNAL FOR RAM Bank0 (Z80L(B0))

The inverted MUX-N signal, which is only switched at special conditions, is used as the latch signal. This signal always occurs but is suppressed in the event of a read cycle occurring with T1 at the same time as Z80 AEN is high. This is to prevent unstable data being read.

3.1.2 Z80 LATCH SIGNAL FOR RAM Bank1 (Z80L(B1))

The inverted MUX-N signal is used for the latch signal. It is allowed to pass through only if it is the first signal during a RD cycle at which the CCLK and the selected RAM Select Signal are low. In all attribute modes the latch signal can only appear once during the read cycle, otherwise the stored attributes will be destroyed. In modes 2 and 3 the data of the output latch is applied to the input buffer. The Output Control Signal of the output latch will be inverted. The bus transceiver is switched to RAM Bank1 only on CPU access.



Detailed Description and Servicing
Terminalboard - Data Buffer

3.2 Write

In order to write, a R/W-N signal is created. This signal must lead the CPU WR-N signal, otherwise, in some cases, the write cycle cannot be done.

The RAS signal is used to produce the R/W-N signal, requiring both the Z80AEN and the output Q-N of the R/W flip flop (item 7404-2) to be high. This flip-flop controls the RD-N signal with the CPU clock. If the RD-N signals stays at high during the rising edge of the T2 (write cycle) a low is latched and the output Q-N will be high. This allows a R/W-N signal to be produced at the next RAS signal. In order to ensure that the R/W-N signal is only formed during a Memory Write Cycle, the CPU RD-N signal is gated with MREQ-N and RFSH-N to produce a control signal for the flip-flop (item 7404-2).

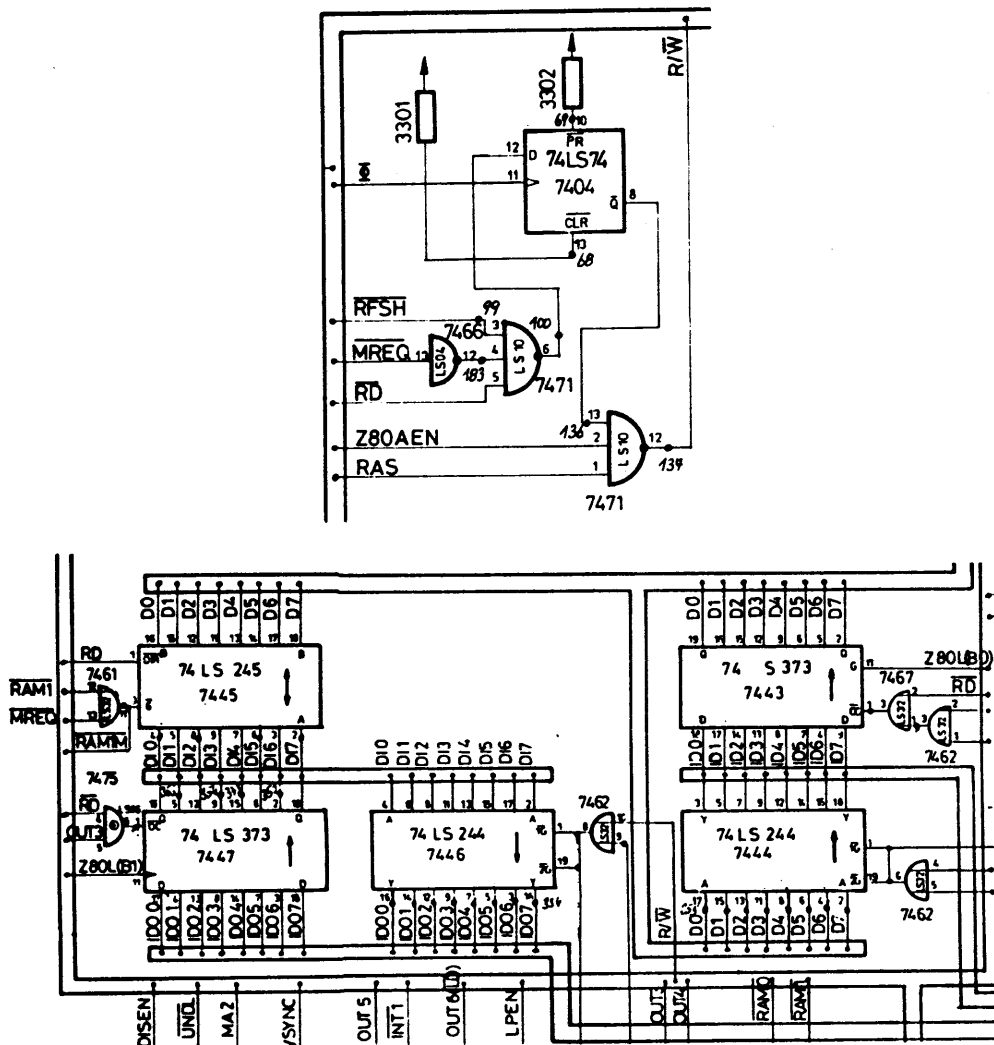
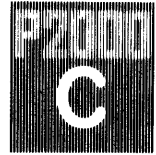
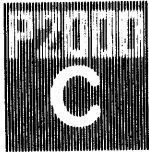

Figure 3.12 Circuit Diagram - Data Buffer

Detailed Description and Servicing
Terminalboard - Data Buffer



THIS PAGE INTENTIONALLY BLANK



Detailed Description and Servicing
Terminalboard - Shift Register

1 GENERAL

The purpose of the shift register is to produce serial dot information from the bytes supplied by the character generator ROM and to ensure that all of the signals necessary for video are present at the same time.

2 BLOCK DIAGRAM

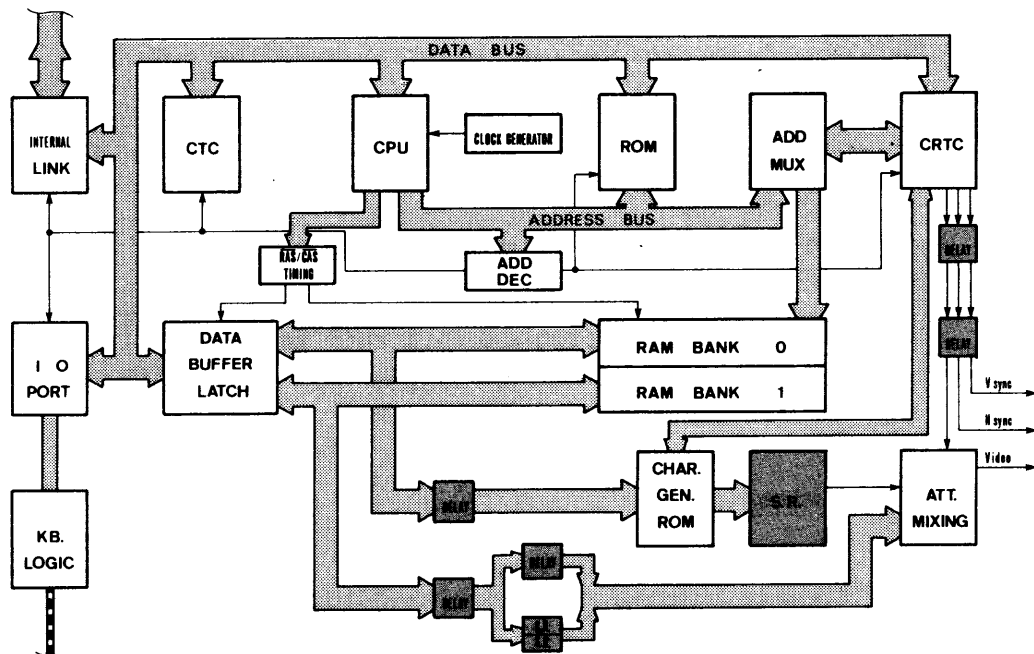
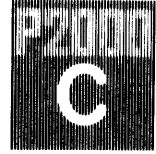

Figure 3.13 P2000C - Shift Register Block Diagram

Detailed Description and Servicing
Terminalboard - Shift Register



3 CIRCUIT DESCRIPTION

3.1 Alphanumeric Mode

In alphanumeric mode, the data is read out of the RAM Bank0 and is stored in a latch (item 7451) at the rising flank of the Z80AEN signal. It is then routed to the character generator ROM (item 7450) as addresses. The row address signals are also applied to the CRTIC and the dot information is read out of the character generator ROM. The parallel load (P-N) signal (derived from item 7457) enables the loading of the shift register (item 7449), followed by shifting out of video data.

Attribute information from RAM Bank1 is delayed by item 7451 and data from RAM Bank0 is delayed by item 7453. As the character generator ROM causes a further delay to the data, the attribute information is also delayed once again using a temporary memory (item 7454). This ensures that dot and attribute information are synchronized.

3.2 Graphics Modes

In the high resolution graphics mode the output of the first shift register (item 7456) is connected to the input of the second shift register (item 7455), the output of which is connected to the output buffer (items 7469/7470). So all 8 bits are shifted out in series.

In the medium resolution mode, both outputs of the shift registers are fed in parallel to the output buffer and so define the brightness of the dot. The half dot frequency is used for the shift frequency in this mode. This is why the dots are double sized compared with the high resolution mode.

3.3 Mode Switching

The signals OUT0 and OUT1 are used to switch modes.

OUT0 switches over between pure alphanumeric and alphanumeric mixed with graphic representation

OUT1 switches over between high and medium resolution graphics

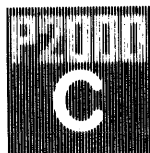

Detailed Description and Servicing Terminalboard - Shift Register

The 74 LS 399 (data multiplexer with memory - item 7476) switches over between the different modes controlled by OUT0. The memory is necessary to equalise the different run times of the gates used for attribute mixing. After buffering (by open collector drivers), the Brightness signals and the Display Enable signal are mixed to become the video signal, which is routed to the monitor.

When mixing alphanumerics and graphics, HRO-N with DOT inactive is the same as inverting HRO-N. If DOT is active, the gate (item 7475), ensures that text superimposed on a graphics display is inverted (pixel by pixel). The LS 157 (item 7477) gives improved contrast in high resolution graphics mode.

3.4 Beeper

The beeper (item 7603) is enabled by the signal OUT2 and driven with the UNDL signal. The signal UNDL is the decoded 10th row of a character line, where the underline is set. (1300 Hz).

3.5 Attribute Mixing

AT0 = Underline: 10th line is decoded out of ROW information from CRTC, UNDL-N, and gated with DOT (active low).

AT1 = Blink: VERT SYNC divided by 16 is gated with DOT-N. (Active high) (This equals 3 changes every 2 seconds). DOT-N is suppressed each 320ms to produce BLINK.
NB See Note below.

AT2 = Invert: DOT-N is inverted if AT2 is active. (Active high)

AT3 = Bright0: These two signals are used to define one of the
AT4 = Bright1: four brightness levels via the 74 LS 399 (item 7476). The C output defines DOT Yes/No and the A and B outputs define the level.

Note: In the new layout, BLINK is software driven, with OUT 7.

Detailed Description and Servicing
Terminalboard - Shift Register

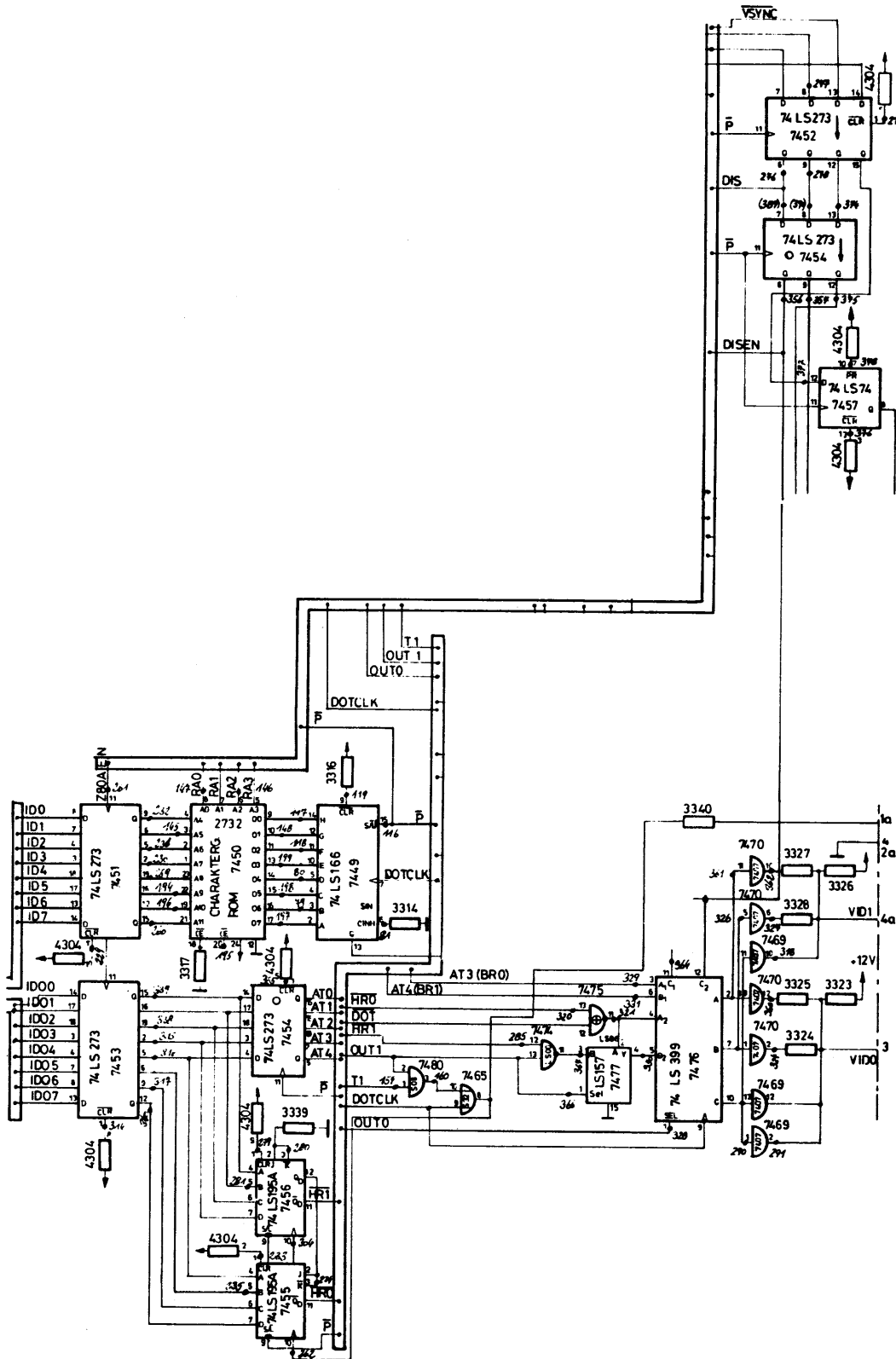
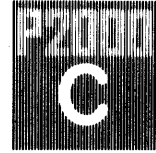
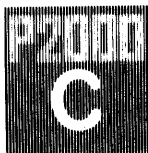

Figure 3.14 Circuit Diagram - Shift Register



Detailed Description and Servicing
Terminalboard - Attribute Mixing

1 GENERAL

The purpose of the attribute mixing circuitry is to ensure that, as each character is read out of the character generator, the dot information is modified according to the required attributes.

2 BLOCK DIAGRAM

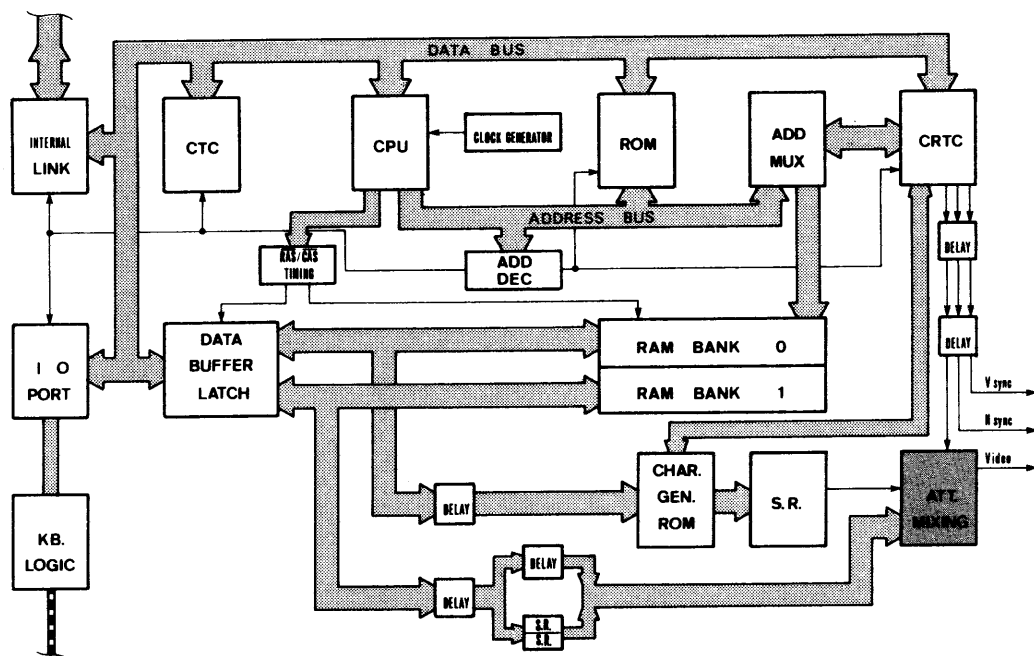
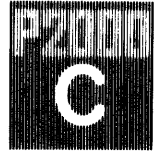

Figure 3.15 P2000C - Attribute Mixing Block Diagram

Detailed Description and Servicing
Terminalboard - Attribute Mixing



3

CIRCUIT DESCRIPTION

The signals AT0 - AT4, derived from the attribute information in Ram Bank1 have the following meanings:

AT0 = Underline
AT1 = Blink
AT2 = Invert
AT3 = Brightness 0
AT4 = Brightness 1

These signals remain valid for the definition of the complete character, i.e., for the full Row Address sequence.

AT3 and AT4 define the brightness level (1 - 4) as either quarter bright, half bright, normal or bold; and are used to determine the 'bright-up' potential applied to the monitor with each ROW of the character being displayed.

The three attributes defined by AT0 - AT2 are carried out by inversion or suppression of the dot information.

- Underline: the dot information for the 10th line of the character is set active
- Blink: the dot information for the complete character is suppressed at a defined frequency
- Invert: the dot information for the complete character is inverted

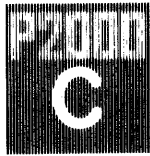

Detailed Description and Servicing
Terminalboard - Attribute Mixing

3.1 Underline

AT0 is gated with UNDL-N (from row addresses RA0, RA3 and RA1 inverted) and then gated with DOT to set the dot information for the 10th line of a character.

This function is carried out with 74 S 00/1-2 (item 7473), 74 LS 10/3 (item 7471), 74 LS 32/2 (item 7467).

3.2 Blink

AT1 is gated with the blink frequency generator signal (derived from VSYNC) to produce a suppression signal at the rate of 3 changes every 2 seconds. During the active period of this signal no character information appears on the screen.

This function is carried out with 74 S 00/3 (item 7473), 74 LS 00/3 (item 7474), 74 LS 293 (item 7468).

Note: From Serial No. 3700, BLINK is carried out by software via OUT7 (Item 7468 is removed and OUT7 connected to pin 10 of item 7474).

3.3 Invert

AT2 will produce a complete inversion of the dot information for the character.

This function is carried out with 74 LS 86/3 (item 7475), 74 S 08/3 (item 7480).

3.4 Beep

UNDL-N is gated with OUT2 to produce the beep signal.

Detailed Description and Servicing
Terminalboard - Attribute Mixing

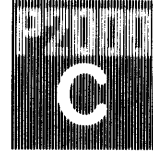

3.5 Video Signals

For each DOT applied to the 74 LS 399 (item 7476), the level of the video outputs VIDO/VID1 is determined by the setting of AT3/AT4 and the resultant A & B outputs. Via the open collector gates (items 7469/7470), one of four levels of video signal will be produced.

In the event of NO DOT being applied, the C output will be active, driving the video outputs to ground (low) potential. Due to the characteristics of the internal monitor, the aiming potential for the video signal, VIDO, is +12V and an additional gate has been incorporated to handle the higher current. This is not required for the external monitor, where the aiming potential for VID1 is +5V.

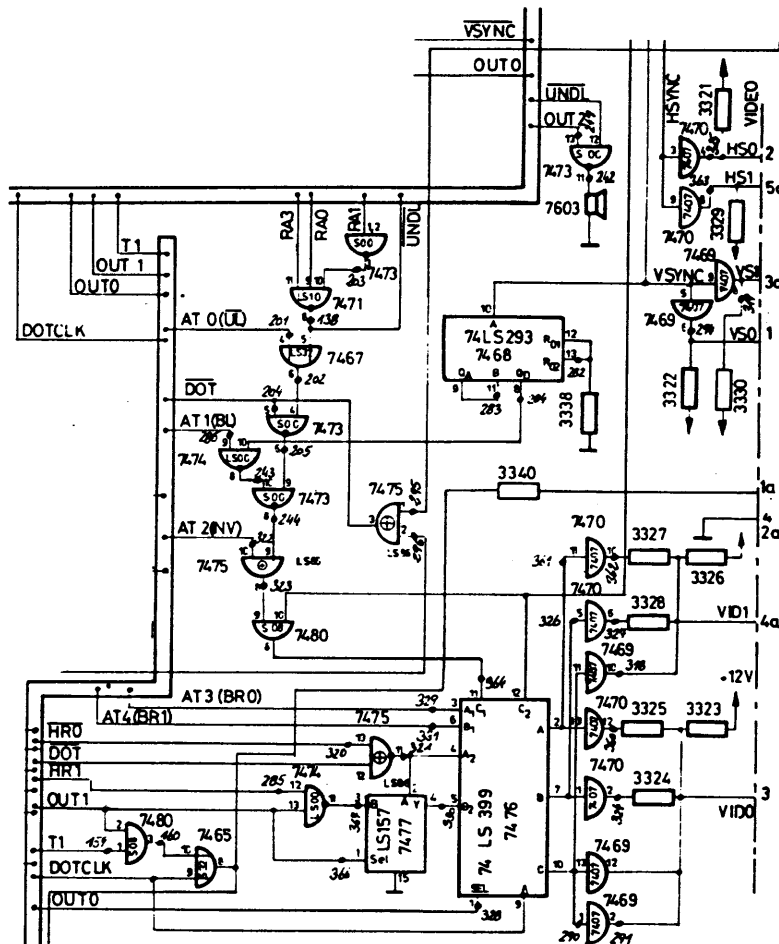
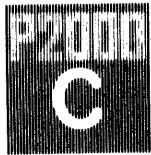

Figure 3.16 Circuit Diagram - Attribute Mixing



Detailed Description and Servicing
Terminalboard - Character Generator ROM

1 GENERAL

The character generator ROM is a 4K x 8 bit device - 2632, (item 7450) giving 256 characters in a 16 x 8 matrix. Only the first 12 x 8 bits are used to define a character, the contents of the remaining 4 x 8 bits being undefined and not addressed by the CRTC. See Appendix A for the Character Generator listing.

2 BLOCK DIAGRAM

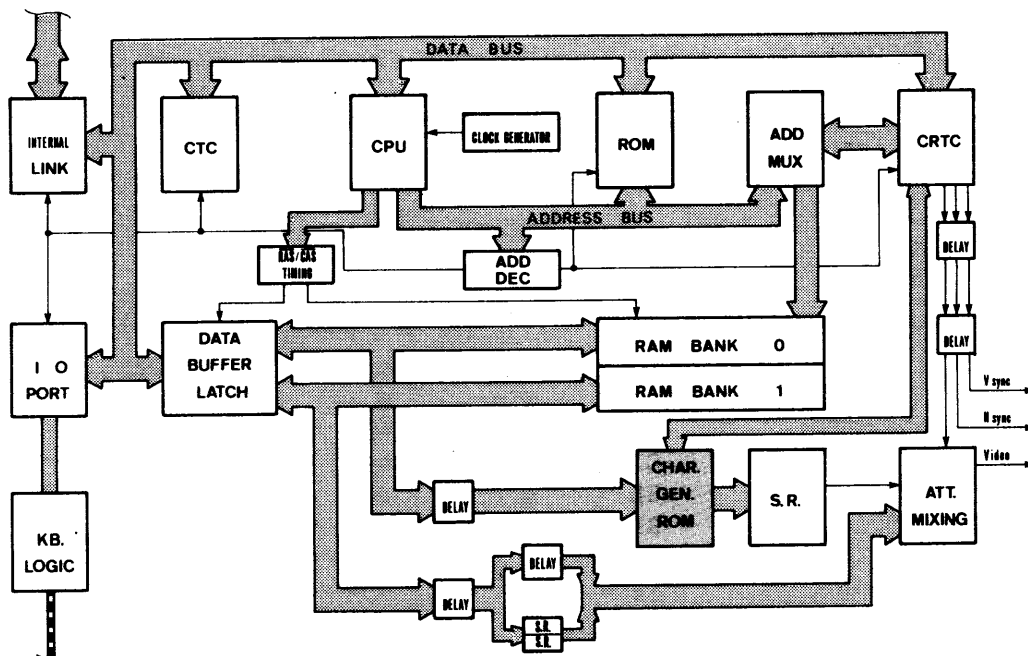
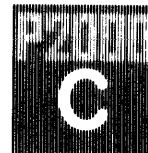

Figure 3.17 P2000C - Character Generator ROM Block Diagram

Detailed Description and Servicing
Terminalboard - Character Generator ROM



3

ADDRESSING

A character is read out of the ROM by clocking out, byte by byte, the 12 bytes that are used to represent that character.

Address lines ID0 - ID7 are first latched from Ram Bank0. (A4 - A11 on the character generator = 000x - 0FFx). This identifies the start address in ROM of the required character.

The Row Address lines RA0 - RA3 are then activated in sequence by the CRTC (A0 - A3 on the character generator = 0 - F, but programmed within the CRTC to count to 12; i.e., 0 - B). One byte of ROM is clocked out to the shift register (item 7449) with each increment of the character clock.

Subsequently the information is shifted out of the shift register, bit by bit, with the least significant bit first.

3.1

Character Representation in ROM

As an example of the ROM contents, the following is the information that represents the letter 'B':

FF C1 BD BD C1 BD BD C1 FF FF FF FF

where 0 (● in illustration below) = bright in normal character display and 1 (• in illustration) = dark.

```

FF = . . . . .
C1 = . . ● ● ● ● .
BD = . ● . . . ● .
BD = . ● . . . ● .
C1 = . . ● ● ● ● .
BD = . ● . . . ● .
BD = . ● . . . ● .
C1 = . . ● ● ● ● .
FF = . . . . .
FF = . . . . .
FF = . . . . .
FF = . . . . .

```

Figure 3.18 Character Representation in ROM

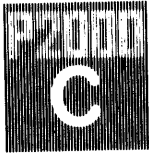

Detailed Description and Servicing
Terminalboard - CTC

1 GENERAL

The Terminalboard uses the same Z80A CTC device as used on the Mainboard (Z8430A). Further information is given under the section describing the Mainboard CTC's.

2 BLOCK DIAGRAM

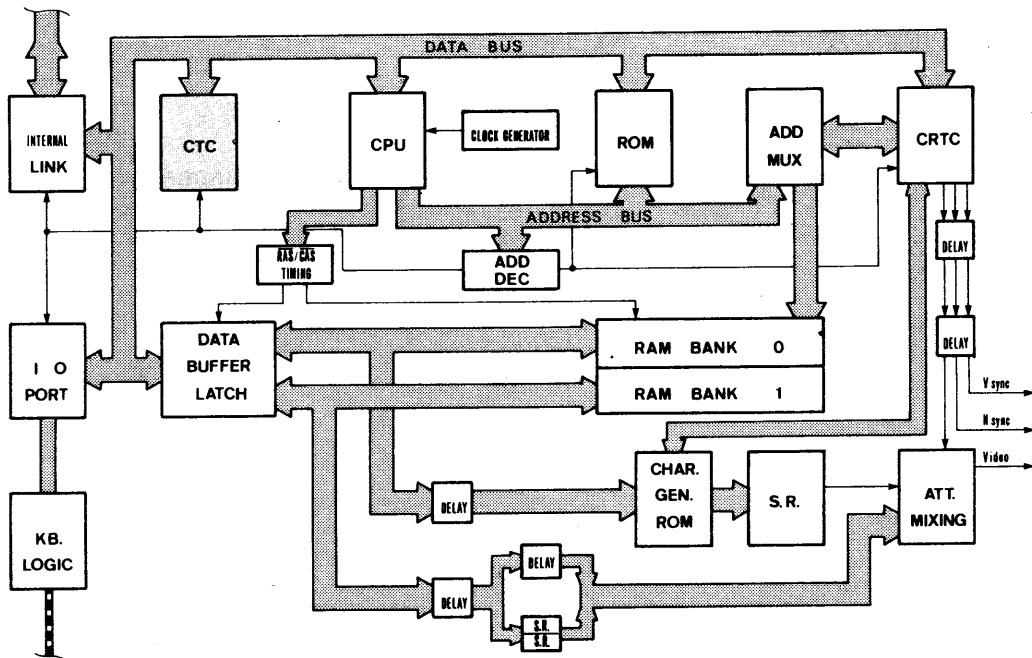
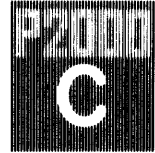

Figure 3.19 P2000C - CTC Block Diagram

Detailed Description and Servicing
Terminalboard - CTC



CIRCUIT DESCRIPTION

The Z80 CTC contains 4 programmable counters and carries out all interrupts in mode 2.

Channel 0 : I/O address 00 - Baud-rate generator

Input frequency of this channel is the system clock signal divided by 5 and output of this channel is the clock for the USART:

CLK	3,072 MHz
CLK/5	614,400 kHz
TO ₀ /2	for USART (duty cycle 50%)

Channel 1 : I/O address 01

Input of this channel is the USART transmitter ready signal and starts USART transmitter interrupts.

Channel 2 : I/O address 02

Input of this channel is the USART receiver ready signal and starts USART receiver interrupts.

Channel 3 : I/O address 03

The input of this channel is connected to the INT1-N of the keyboard logic and starts the interrupt for the keyboard handling.



Detailed Description and Servicing
Terminalboard - CTC

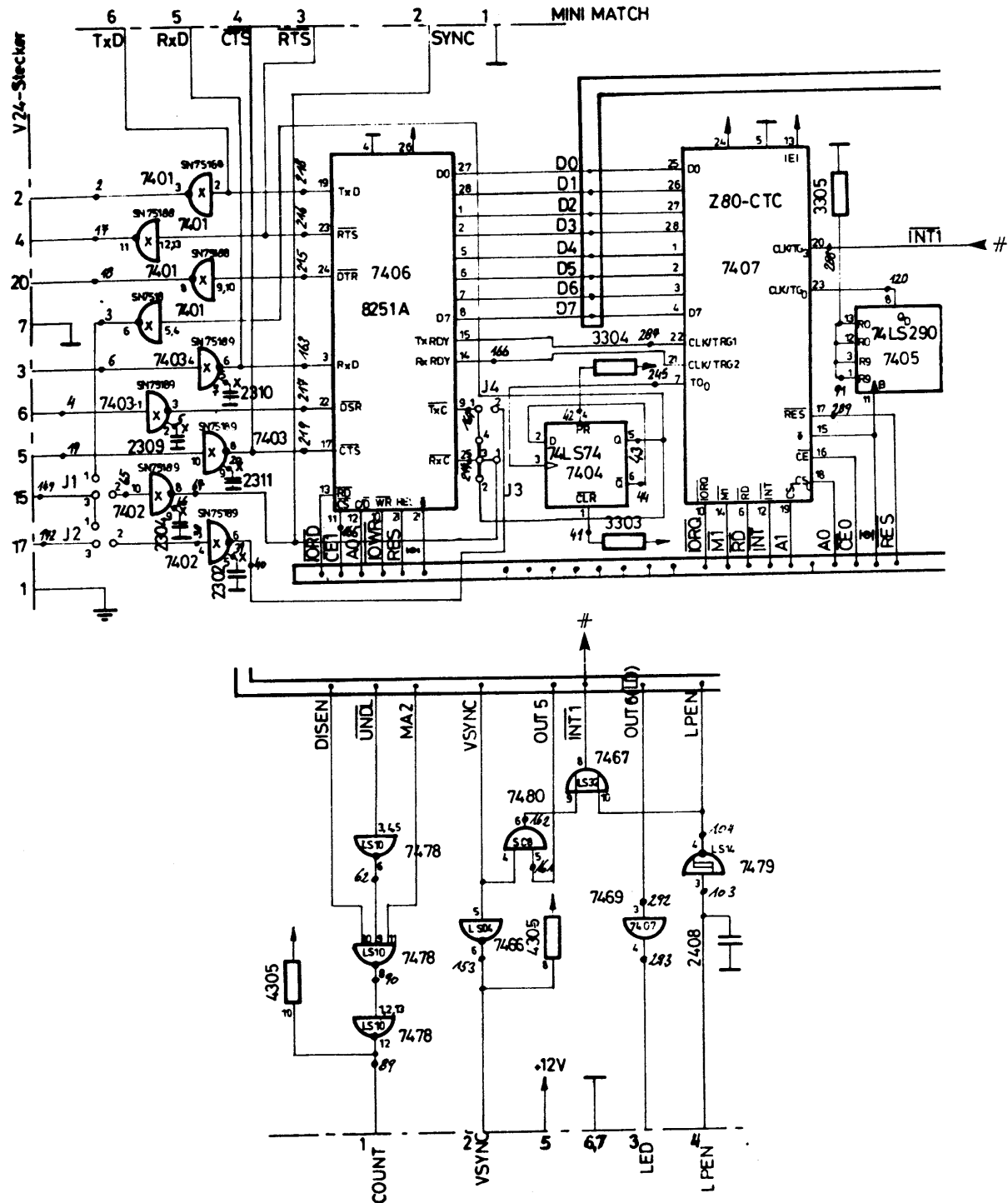
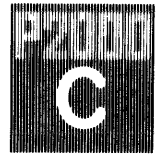

Figure 3.20 Circuit Diagram - CTC

11-4

Detailed Description and Servicing
Terminalboard - CTC



THIS PAGE INTENTIONALLY BLANK

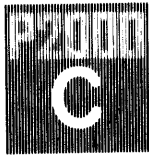

Detailed Description and Servicing
Terminalboard - V24/Internal Interface

1 GENERAL

The optional V24 connection and the internal link to the Mainboard is controlled by a USART 8251A (item 7406) identical to that used on the Mainboard. Further information on the device can be found in that section.

The link connection to the Mainboard is direct, at TTL levels; the V24 connections (used only when the Terminalboard is used as a stand-alone terminal) are buffered by open collector devices (items 7401, 7402 and 7403).

The receiver and transmitter clocks may be internal (CTC channel 0) or external; selected by Jumpers J1 to J4.

2 BLOCK DIAGRAM

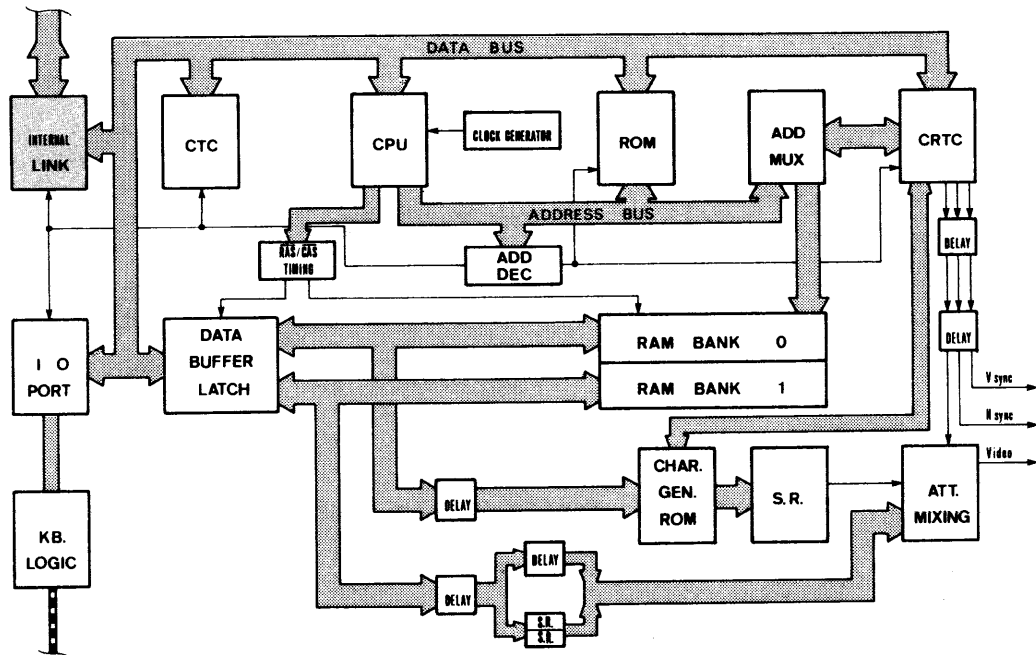
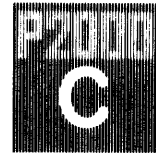

Figure 3.21 P2000C - V24/Internal Interface Block Diagram

Detailed Description and Servicing
Terminalboard - V24/Internal Interface



3 CONNECTIONS

3.1 Internal Link Connector

The connections are reversed in comparison to the internal link connector on the Mainboard. The pinning is as follows:

<u>Tb Pin</u>	<u>Signal</u>	<u>Mb Pin</u>
1	GND	6
2	SYNC	5
3	RTS-N	4
4	CTS-N	3
5	RxD	2
6	TxD	1

3.2 V24 (Optional) Connector

The optional V24 connector includes the standard V24 connections and two pins for external sync signals in conjunction with jumpers J1 to J4. The pinning is as follows:

<u>Pin</u>	<u>Signal</u>
1	Protective GND
2	TxD
3	RxD
4	RTS-N
5	CTS-N
6	DSR-N
7	GND
15	Ext Rx Clock
17	Ext Tx Clock
20	DTR-N

3.3 Jumpers

In the standard configuration, the V24/Internal interface operates with the jumpers J1 - J4 set as follows:

- J1 - No links
- J2 - No links
- J3 - Links between 4 and 3
3 and 2
3 and 1
- J4 - No links



Detailed Description and Servicing
Terminalboard - V24/Internal Interface

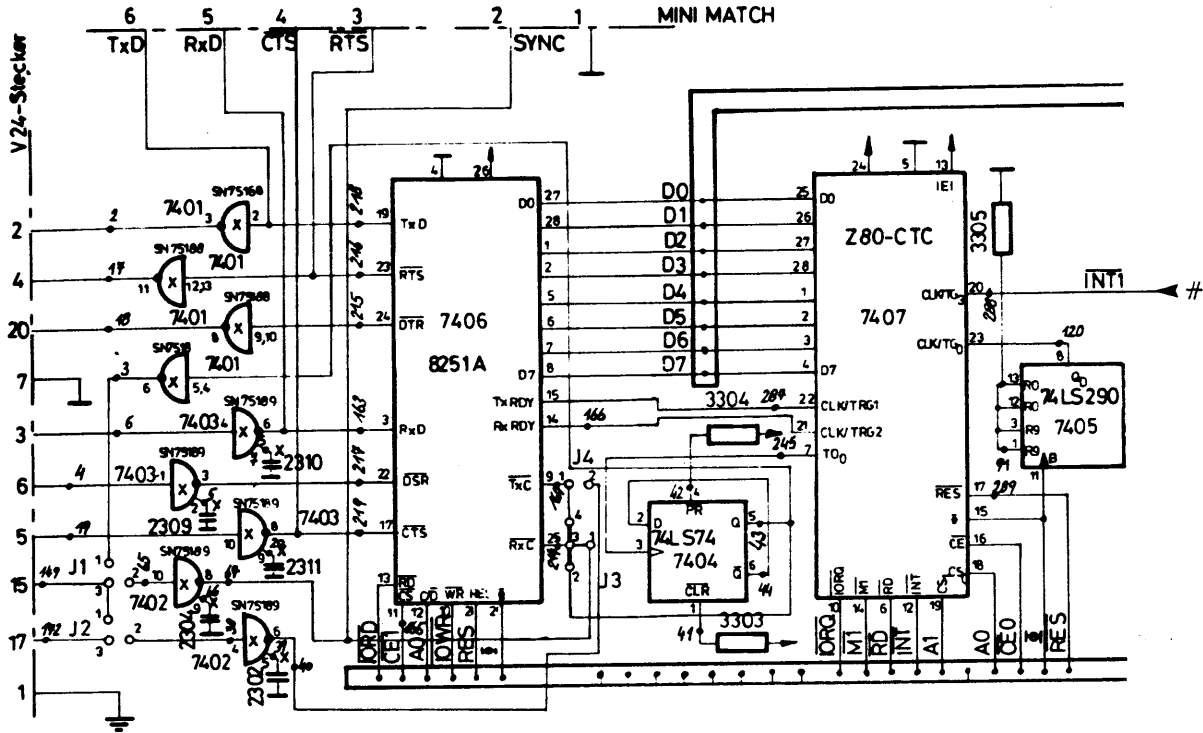
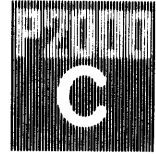

Figure 3.22 Circuit Diagram V24/Internal Interface

12-4

Detailed Description and Servicing
Terminalboard - V24/Internal Interface



THIS PAGE INTENTIONALLY BLANK

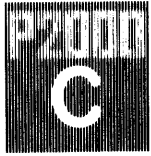

Detailed Description and Servicing
Terminalboard - Address Decoder

1 GENERAL

As mentioned in the CPU description, some of the CPU addresses are decoded as detailed in the following paragraphs.

2 BLOCK DIAGRAM

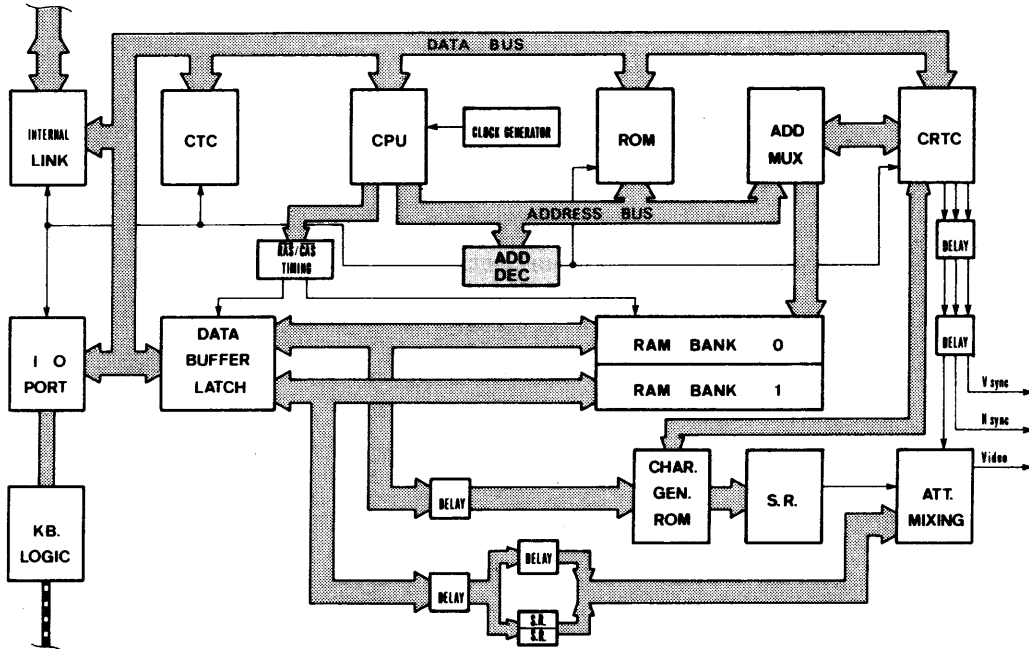
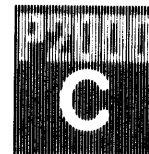

Figure 3.23 P2000C Address Decoder - Block Diagram

13-2

Detailed Description and Servicing
Terminalboard - Address Decoder



3 CIRCUIT DESCRIPTION

3.1 Address Lines A14 - A15

A14 and A15 are decoded by a 74 S 139 (item 7410), controlled by RFSH-N from the CPU, to produce RAM0-N and RAM1-N for the selection of RAM Banks 0 and 1. These addresses are also used to produce the EPROM 0 CE-N signal which is used as the CS-N input for the Program ROM (item 7409).

3.2 Address Lines A6 - A7

A6 and A7 are decoded by the other part of item 7410, controlled by the signal M1-N from the CPU, to produce chip enable signals for the CTC (CE0-N), the USART (CE1-N) and the CRTC (CE2-N). These addresses are also used to produce the signals OUT-N and IN-N, (by gating with I/O, read and write signals) for controlling data I/O (items 7441/7442).

3.3 Address Lines A0 - A1

A0 and A1 are linked directly to the CNTR bus, where they are used:

- at the USART for control/data indication (C/D-N with A0)
- at the CTC for chip select (CS0:A0 - CS1:A1)
- at the CRTC for read/write indication (R/W-N with A1) and register select (RS with A0)



Detailed Description and Servicing
Terminalboard - Address Decoder

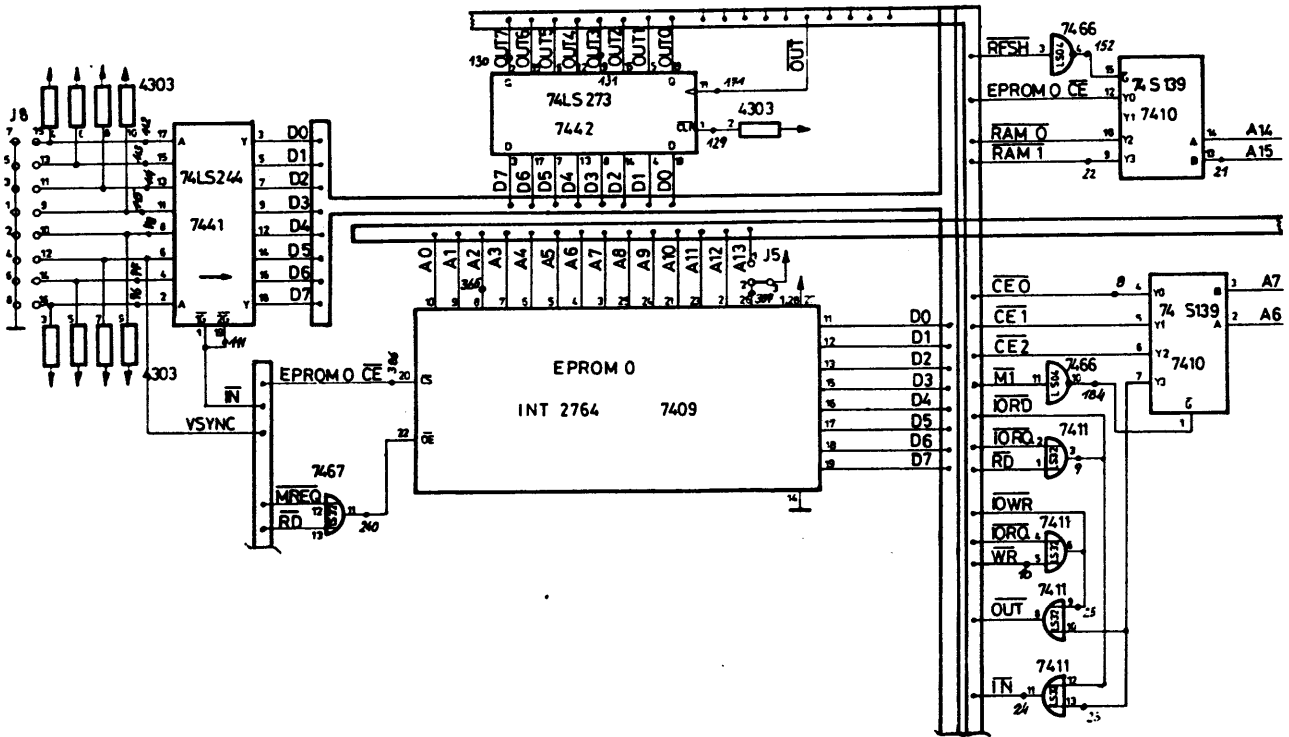
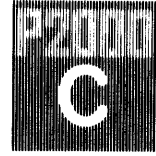

Figure 3.24 Circuit Diagram - Address Decoder

13-4

Detailed Description and Servicing
Terminalboard - Address Decoder



THIS PAGE INTENTIONALLY BLANK

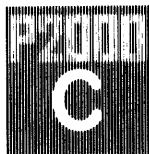

Detailed Description and Servicing
Terminalboard - Keyboard Logic

1 GENERAL

To reduce the number of connection lines between the Keyboard and the Terminalboard a serial interface is used. To make this possible the system uses a counter (fitted inside the keyboard) which is controlled by the video refresh address MA2.

2 BLOCK DIAGRAM

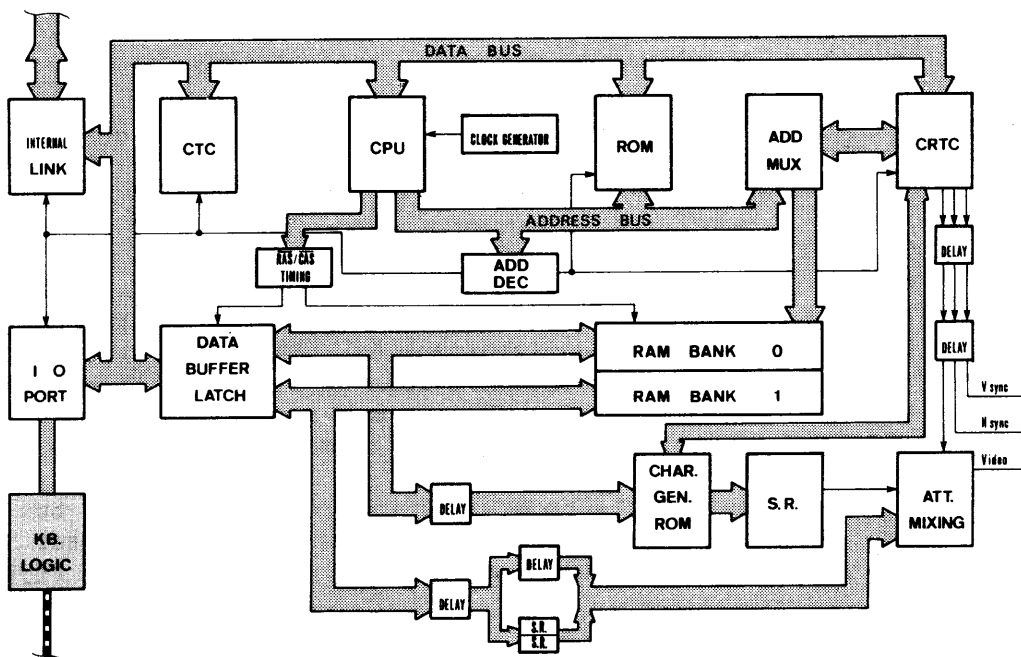
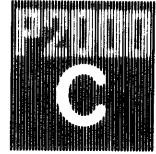

Figure 3.25 P2000C Keyboard Logic - Block Diagram

Detailed Description and Servicing
Terminalboard - Keyboard Logic



3

CIRCUIT DESCRIPTION

MA2 is used as a clock, and is gated by UNDL-N on the 10th row of each character line. The counter 'counts up' to 10 in each character line, controlling the inputs to a 16 to 1 data selector, the first 10 inputs of which are the columns of the keyboard (10 column x 16 row) key matrix. The overflow of the decimal counter is used to control a binary counter, which applies a low signal to each of the 16 rows of the key matrix in turn.

On the keyboard key matrix, rows 1 to 10 are used for normal keys and rows 12 - 15 are used for special functions (control, shift, shift lock, supershift).

When the active row and column co-incide with a pressed key, the output of the data selector goes high, sets a flip-flop, and releases a light pen strobe. As the light pen strobe co-incides with a video refresh address (which distinguishes the pressed key), this address is loaded to the light pen register by the CRTIC.

A further key depression in the same scan period will cause the new key, which may be a special function key from rows 12 - 15, to be encoded. Only one special function key is allocated to each of these four rows. In order to allow enough time for interrupt handling the 11th row is not used. The 16th row is used to disable the counter input.

The VSYNC signal is used to reset the counters. The LED in the shift lock key can be set with OUT6. An interrupt is released by the light pen strobe via CTC. The interrupt routine sets OUT5 and enables an interrupt by VSYNC. When an interrupt (by VSYNC) appears it will wait for the light pen strobe. A repeat function is built in when a key remains depressed, giving a sufficient pause for normal keyboard handling not to cause unwanted repeats.

Because the CRTIC is programmed for 24 rows per page but the key board matrix consists of 16 rows only, the counter input is locked from row 16 and is opened again with the next VSYNC.



Detailed Description and Servicing
Terminalboard - Keyboard Logic

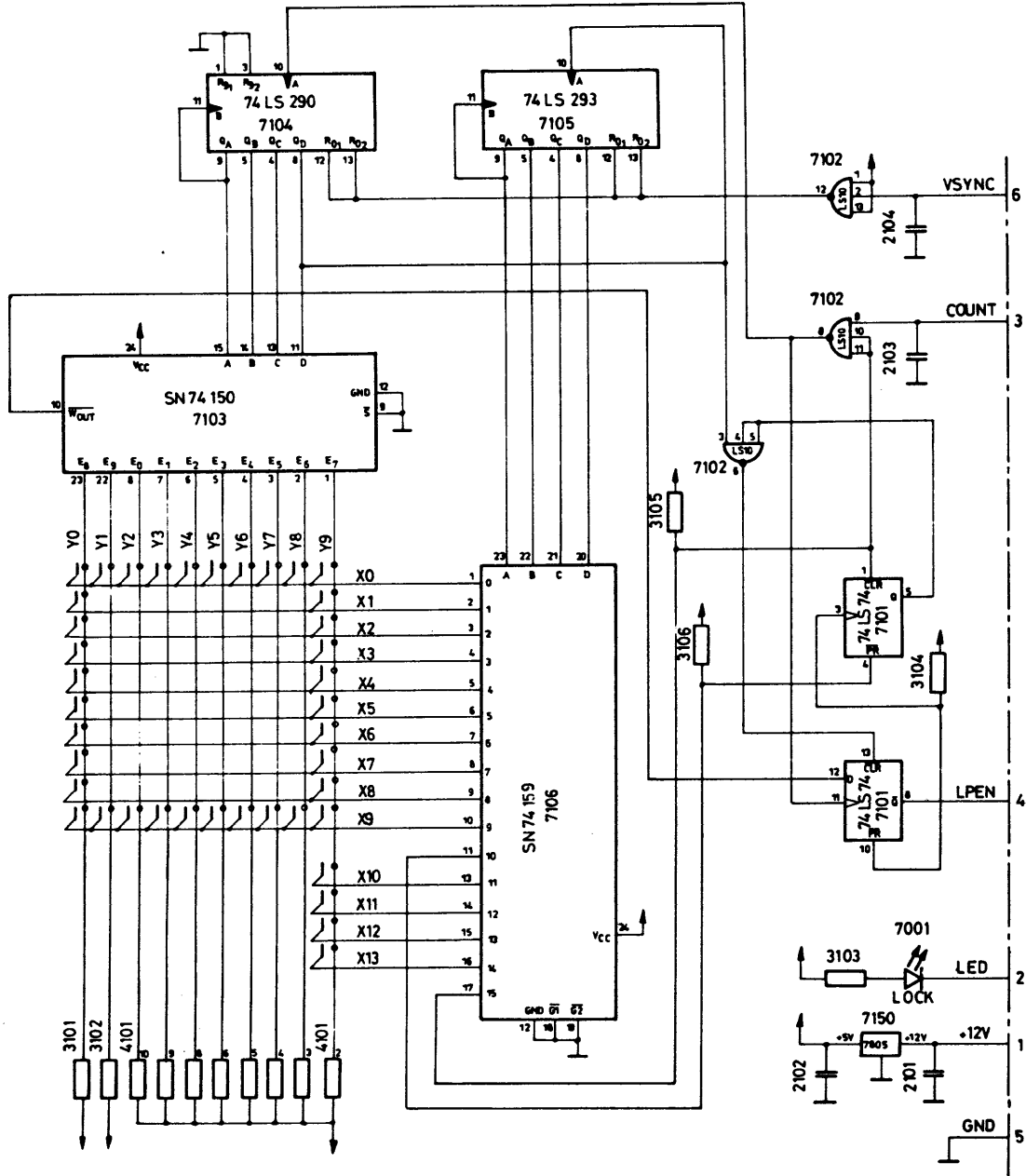
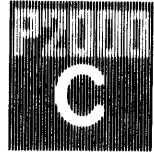

Figure 3.26 Circuit Diagram - Keyboard Logic

14-4

Detailed Description and Servicing
Terminalboard - Keyboard Logic



THIS PAGE INTENTIONALLY BLANK

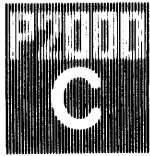

Detailed Description and Servicing
Terminalboard - I/O Ports

1 GENERAL

The Terminalboard I/O ports are given in the table in paragraph 3.

2 BLOCK DIAGRAM

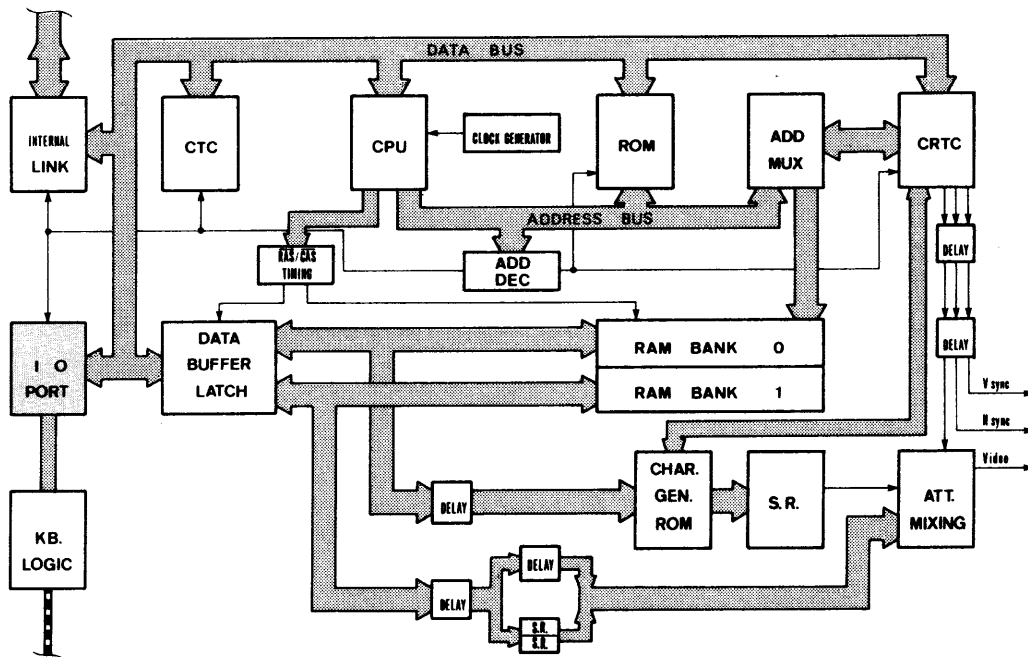
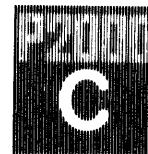

Figure 3.27 P2000C I/O Ports - Block Diagram

Detailed Description and Servicing
Terminalboard - I/O Ports



3 I/O PORTS

Port	Use
00 - 3F	CTC read & write
40 - 7F	8251 USART read & write
80 - BF	CRTC 6845
80	write address register
81	write register
82	read status register
83	read register
C0 - FF	IO Ports (OUT0 - OUT7, IN0 - IN7)
OUT0	alphanumeric/graphic mode
OUT1	high resolution/half resolution
OUT2	beeper
OUT3	block move/block write
OUT4	block move/block write
OUT5	vertical sync interrupt enable
OUT6	shift lock LED
OUT7	blink
IN5	vertical sync input

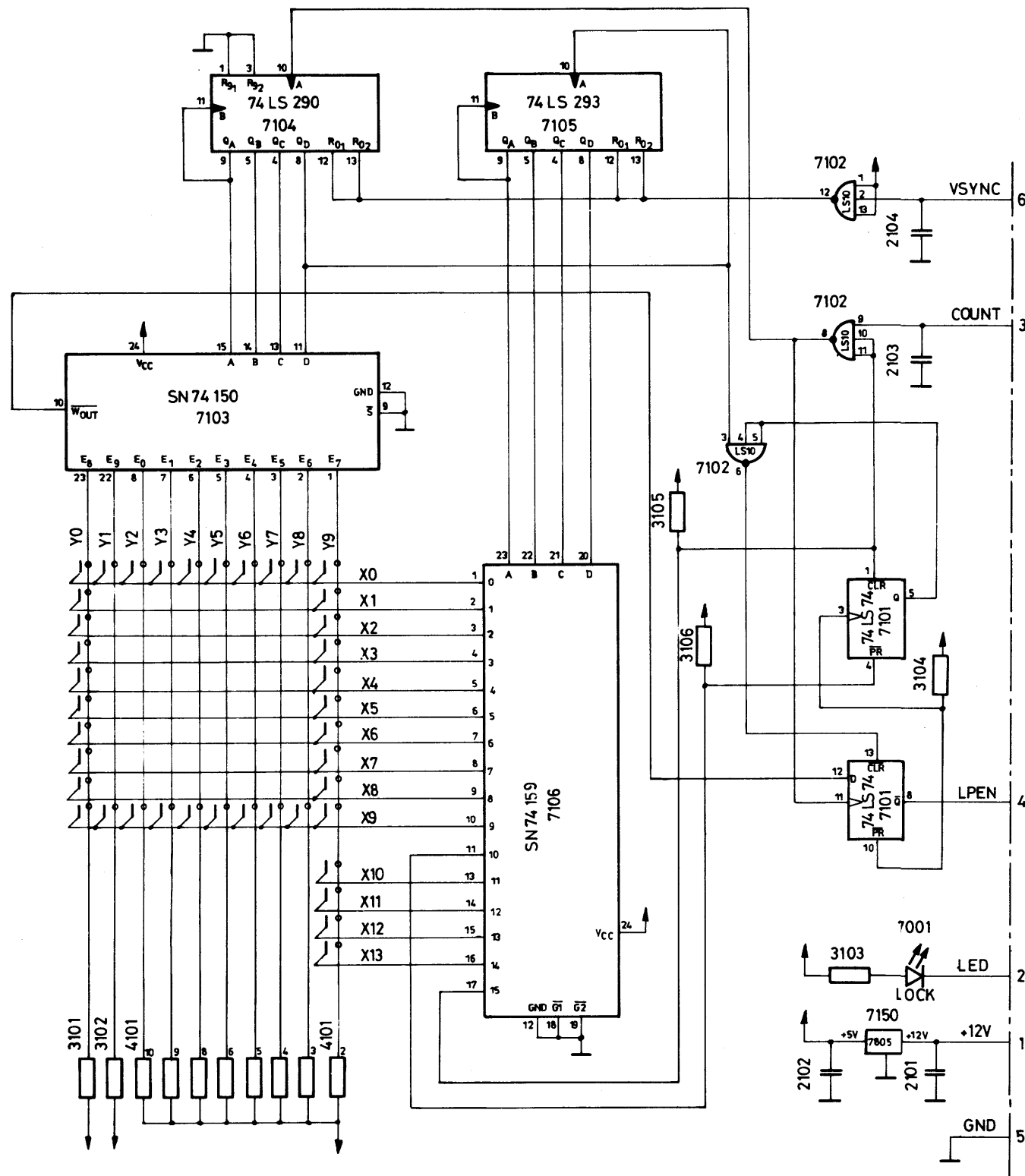

X0	Y9	X0	Y0	X0	Y1	X0	Y8	X0	Y7	X0	Y6	X0	Y5	X0	Y4	X0	Y3	X9	Y2	X7	Y2	X8	Y2	X8	Y3	X8	Y4
X1	Y9	X1	Y0	X1	Y1	X1	Y8	X1	Y7	X1	Y6	X1	Y5	X1	Y4	X1	Y3	X1	Y2	X6	Y2	X7	Y3	X6	Y3	X5	Y3
X13	Y9	X2	Y9	X2	Y0	X2	Y1	X2	Y8	X2	Y7	X2	Y6	X2	Y5	X2	Y4	X2	Y3	X2	Y2	X5	Y2	X4	Y3		
X11	Y9	X3	Y9	X3	Y0	X3	Y1	X3	Y8	X3	Y7	X3	Y6	X3	Y5	X3	Y4	X3	Y3	X3	Y2	X4	Y2	X11	Y9		
X10	Y9	X12	Y9	X4															Y9	X12	Y9	X10	Y9				

X8	Y5	X8	Y6	X8	Y7
X7	Y4	X7	Y5	X7	Y6
X6	Y4	X6	Y5	X6	Y6
X5	Y4	X5	Y5	X5	Y6
X4	Y4	X4	Y5	X4	Y6

X8	Y8	X8	Y1	X8	Y0
X7	Y7	X7	Y8	X7	Y1
X6	Y7	X6	Y8	X6	Y1
X5	Y7	X5	Y8	X5	Y1
X4	Y7	X4	Y8	X4	Y1

X4	Y4
X7	Y0
X6	Y0
X5	Y0

- 1
- 2
- 3
- 4
- 5
- 6
- 7
- 8
- 9
- 10
- 11
- 12
- 13
- 14
- 15
- 16
- 17
- 18
- 19
- 20
- 21
- 22
- 23
- 24
- 25
- 26
- 27
- 28
- 29
- 30

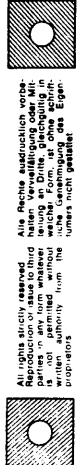

Subscription

12/4

UN 026	TOLERANCES UNLESS OTHERWISE STATED	MASS	DIAMENSION	ANGLE
(µm)	MASS OHNE TOLERANZANGABE	MASS	WINKEL	
GENERAL ROUGHNESS ALLGEMEINE RAUHEIT	UNIT EINH mm	MATERIAL		
SCALE MASZSTAB	PROJ EUROP	TREATMENT BEHANDLUNG		
CLASS NO	printed board, assy		5103 108 02760	
NAME Schöberl		PROPERTY OF		DATE 83-11-04
WR P 2000 C		E 41		130-01

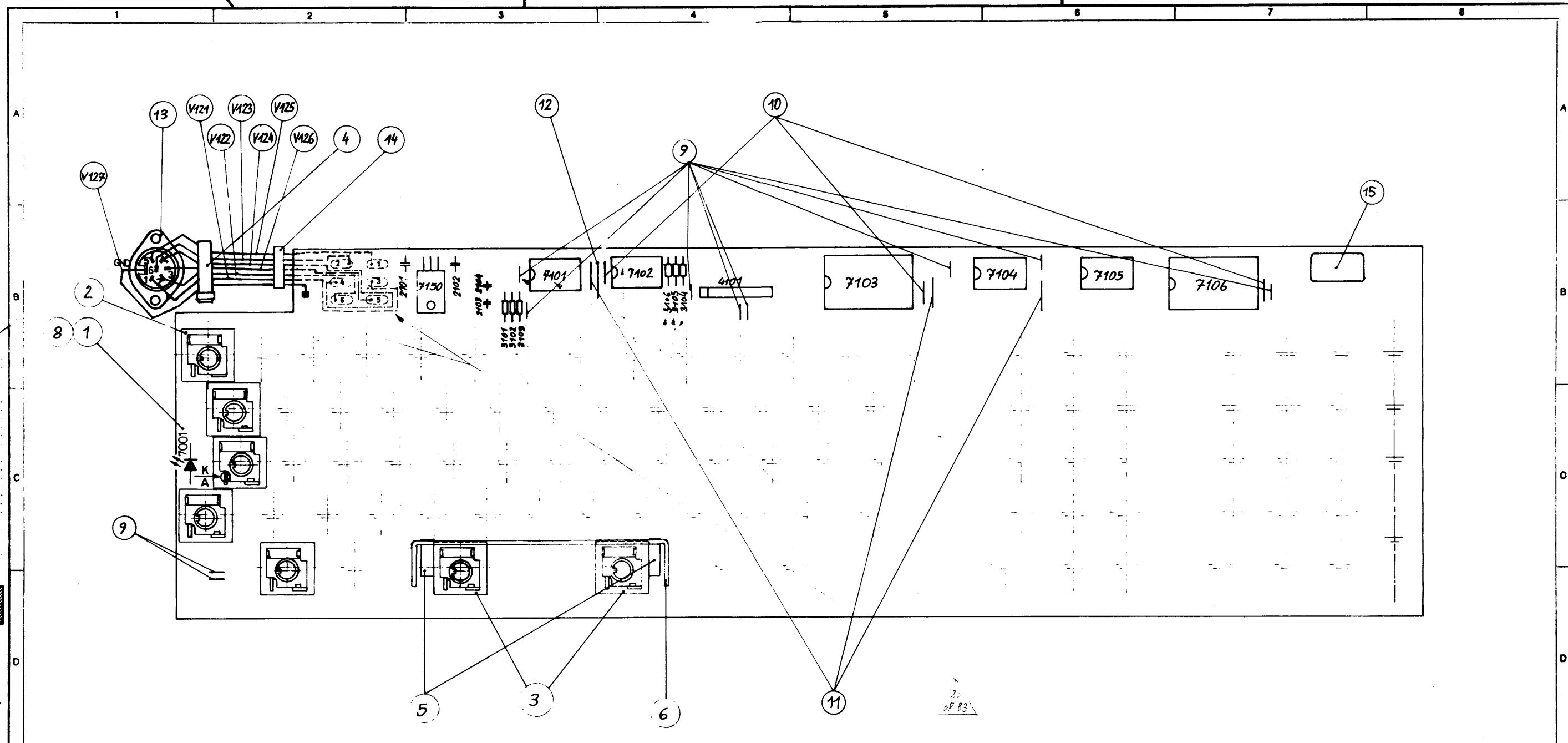

V121... blue/blau	Count	from/von Keyboard-Buchse 1	to/nach Printplatte-Pin 3
V122... brown/braun	Vsync	2	6
V123... red / rot	Led	6	2
V124... white/weiß	Lpen	4	4
V125... orange	+12V	5	1
V126... black/schwarz	Ground	3	5
V127... - - -	Ground	GND	Schirm

für Transportverpackung siehe 5103 106 60900!

UN-D 28	UN-D 800	5103 108 0276	1
GENERAL ROUGHNESS ALLGEMEINE RAUHEIT	UNIT ERW. MM	MATERIAL	PATTERN NO. / MODELL NR.
SCALE MAßSTAB	PROJ. EQUIV.	TREATMENT BEHANDLUNG	
CLASS NO. 3K1000	printed board, Assy	5103 108 0276	1.02.01.83
16.06.83	Printplatte, Zus. (Keyboard, Tastenprint)		1.02.01.83/100
STEININGER	8203 235 17110	E 41	110-01
P 2000 C	PROPERTY OF OSTERREICHISCHE PHILIPS INDUSTRIE GESELLSCHAFT M.B.H. BANDGERÄTEWERK A 1141 WIEN, SCHNITTENSTRASSE 118		DAT. 11-05-83 A.2



Detailed Description and Servicing Keyboard

1

GENERAL

The keyboard has been specially designed for the P2000C microcomputer, with particular attention having been paid to the ergonomic requirements of the professional user. It is a low profile unit with sculptured keys on the typewriter section and has separate function and numeric pads. An LED is incorporated in the 'shift lock' key to indicate that the keyboard is in the shift lock mode.

The keyboard is separate from the main unit and connected by a spiral cable. It contains only the keyswitch matrix and a few TTL packages, which reduces the number of wires required in the connecting cable.

For transportation the keyboard fits inside the fascia of the main unit and is secured by the carrying strap. The keyboard connecting cable is stowed, with the mains cable, in a compartment at the back of the unit.

1.1

National Versions

Although the keyboard is obtainable in various National Versions, the electronics of each is identical and only the keytops differ. The adaptation of the basic keyboard to meet national requirements is carried out by the use of the Keyboard and Video Tables. (See CP/M Configuration Program).

This chapter contains illustrations of two of the National keyboards - Austrian/German and United Kingdom.

Detailed Description and Servicing
Keyboard

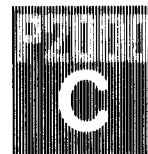

2 CIRCUIT DESCRIPTION

The keyboard is scanned in synchronization with video refresh operation of the CRTC. At each key depression the light pen input is activated and the key is identified by means of the light pen register in the CRTC. (This restricts the use of the keyboard to functioning with the video circuits).

Key rollover and key lockout depends on the position of the key in the scanning row. If the 'key 2' is depressed while 'key 1' remains depressed; two situations are possible:

- If 'key 2' stands later in the scanning row than 'key 1', it will be encoded when 'key 1' has been released.
- If 'key 2' stands earlier in the scanning row it will be encoded immediately.

Special keys (shift, supershift, control and shift lock are encoded whenever they are depressed.

The circuit action is described further under Terminalboard - Keyboard Logic.

2.1 Pinning

The keyboard cable 5103 107 81270 with 2 plugs 6-pole DIN 45 322 (240°) has the following pin designation:

PIN	SIGNAL	I/O
1	count	0
2	vertical sync	0
3	led	0
4	light pen	I
5	+12v	0
6	gnd	0
	screening to gnd	



Detailed Description and Servicing
Keyboard

3 NATIONAL VERSION KEYBOARDS

3.1 National Version Keyboard - Austrian/German

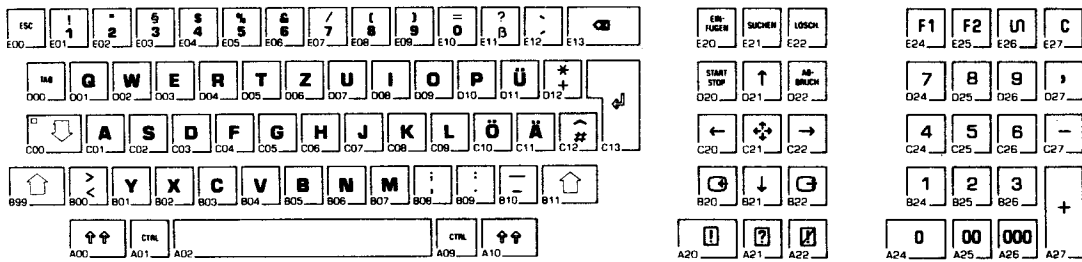

3.2 National Version Keyboard - United Kingdom

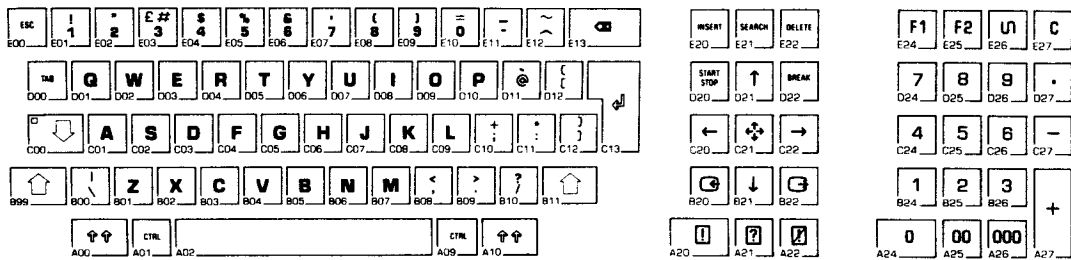

Detailed Description and Servicing
Keyboard

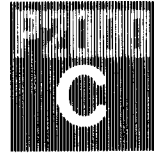

THIS PAGE INTENTIONALLY BLANK



Detailed Description and Servicing
Monitor

1 GENERAL

The P2000C incorporates a Mitsubishi Electronic Corporation Model NT-1002XU, 9" Monochrome (Green) Monitor. The maintenance philosophy for this unit is that it should be 'serviced by replacement' and, consequently, full technical details will not be supplied. However, this section outlines the safety precautions to be taken when handling and using the unit and will give instructions on any adjustments that may be needed.

2 SAFETY PRECAUTIONS

HIGH VOLTAGE WARNING

Parts of the CRT PCB are supplied with **HIGH VOLTAGE (700V)**, and extreme care must be taken in handling the unit when it is switched 'ON'.

Even after switching 'OFF', the CRT **ANODE** may be at a dangerous voltage level. This high voltage should be discharged to ground after the **ANODE CAP** has been carefully removed.

HIGH VOLTAGE WARNING

In addition to precautions against fatal electric shock, the following points should be considered when handling or using the Monitor:

- Although an anti-explosive type CRT is used in the Monitor, any damage to the tube is potentially dangerous. Care must be taken in handling the Monitor to ensure that the surface of the CRT is not damaged. Remember that any damage to the tube will affect both **SAFETY** and **PICTURE QUALITY**.
- The anode cap is held firmly in place by the cap spring. Ensure that this item is always fitted.
- To preserve 'tube life', it is advisable to use the lowest acceptable brightness level for the display. This will lessen the effect of phosphor burn on the tube.

1-2

Detailed Description and Servicing
Monitor

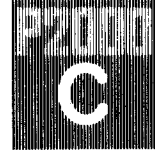

- Avoid moving the sub-magnets on the deflection yoke, which compensate for linearity and raster distortion. Extreme care should be taken when handling the deflection yoke to avoid damage to the wiring.

3

ADJUSTMENTS**HIGH VOLTAGE WARNING**

Adjustments to the Monitor must only be carried out by a qualified Service Technician.

HIGH VOLTAGE WARNING

Connect appropriate power source and TTL signals to the module as follows:

Power Source	DC 12V +/-0.2V
Video	TTL positive 5V P-P
Vertical Sync	TTL negative 5V P-P
Horizontal Sync	TTL positive 5V P-P

The following procedures outline adjustments for individual stages:

3.1 Horizontal Frequency (VR501)

- Disconnect input signal
- Connect a frequency counter (loose coupling) to horizontal output
- Adjust VR501 for output of 15.67 KHz

3.2 Vertical Frequency (VR401)

- Connect input signal
- Adjust VR401 to stabilize picture in vertical plane

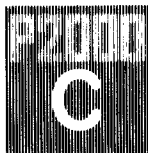

Detailed Description and Servicing
Monitor

3.3 Horizontal Width (L502)

- Input full dots test pattern at appropriate brightness level
- Adjust L502 to give horizontal width of 165 +/- 2mm

3.4 Vertical Height (VR402) and Vertical Linearity (VR403)

- Input cross-hatch test pattern
- Adjust VR402 and VR403 to obtain required vertical height with best possible vertical linearity

3.5 Picture Centering

- Rotate the two 'centering magnetic rings' of the deflection yoke to centralize the display on the CRT screen.

If the displayed data is 'tilted', this may be corrected by loosening the screw holding the deflection yoke and rotating the yoke to correct the display.

Note: The deflection yoke must be pushed home firmly before tightening the screw.

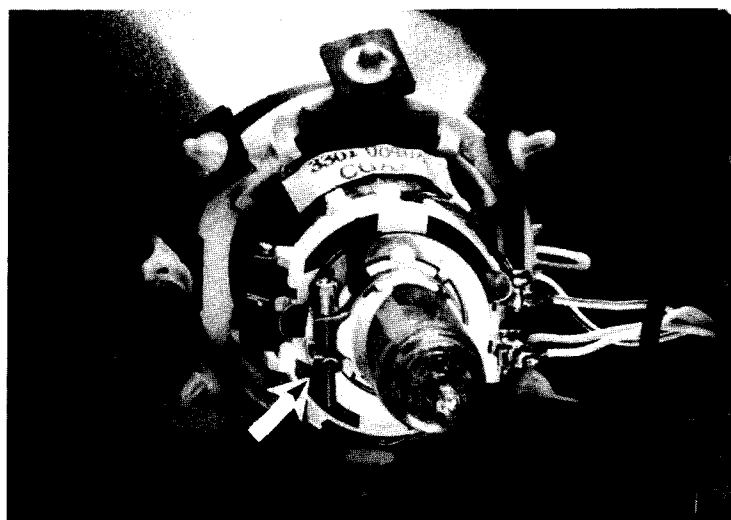

3.6 Focus (VR203)

- Adjust VR203 to obtain best possible focussing within the display area.

Detailed Description and Servicing
Monitor

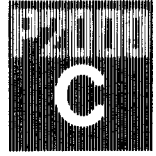

THIS PAGE INTENTIONALLY BLANK



Detailed Description and Servicing
Disk Drives

1

GENERAL

The Flexible Disk Drives fitted to the P2000C are the TEAC Corp 5 $\frac{1}{4}$ " Slim Line FD-55 drives. Two versions are available:

TEAC FD 55A - 160K Single Sided, single track density (48tpi)
TEAC FD 55F - 640K Double Sided, double track density (96tpi)

Information available at publication date indicates that these drives will be superceded by the "L" version of each type:

TEAC FD 55A (L) and TEAC FD 55F (L)

Information concerning the operation and servicing of these drives is available from the manufacturer, and interested readers are referred to the following specifications:

TEAC FD 55A Spec P/N 10530146 - 00A
TEAC FD 55F Spec P/N 10530146 - 03A

TEAC FD 55A(L) Spec P/N 10530160 - 00A
TEAC FD 55F(L) Spec P/N 10530160 - 03A

1-2

Detailed Description and Servicing
Disk Drives

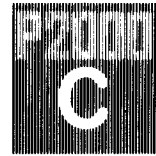

2

OPERATIONAL CHARACTERISTICS

The following characteristics are extracted from the specifications for the various drives mentioned in paragraph 1.

2.1

Data Capacity

Data capacity assuming MFM recording:

	640 K	160K
Data transfer rate (K bits/sec)	250	250
Tracks per disk	160	40
Inner track bit density (bpi)	5,922	5,536
Inner track flux density (frpi)	5,922	5,536
K bytes/track - Unformatted	6.25	6.25
K bytes/disk - Unformatted	1000	250
K bytes/sector - Formatted	0.256	0.256
K bytes/track - Formatted	4.096	4.096
K bytes/disk - Formatted	655.3	163.84
(formatted = 16 sectors per track)		

2.2

Disk Rotation Mechanism

All types.

- Spindle motor:	Direct DC brushless
- Spindle motor speed:	300 rpm
- Motor servo:	Frequency servo by AC tachometer
- Motor/spindle connection:	Motor shaft direct
- Disk speed:	300 rpm
Long term speed variation (LSV):	Less than +/- 1.5%
Instant speed variation (ISV):	Less than +/- 1.5%
- Start time:	Less than 400msec
- Average latency:	100msec



Detailed Description and Servicing
Disk Drives

2.3 Index

All types.

- Number of index: 1 per disk revolution
- Detection method: LED and photo-transistor
- Detection cycle: 200msec +/- 1.5%
- Index/alignment dipole spacing: 0 - 400usec, with specified test disk

2.4 Track Construction

		640 K	160K
Track density:		96tpi	48tpi
Number of cylinders:		80	40
Number of tracks per surface:		80	40
Number of tracks per disk:		160	40
Outermost track radius (track 00)	Side 0	57.150mm	57.150mm
	Side 1	55.033mm	-
Innermost track radius (track 79/39)	Side 0	36.248mm	36.513mm
	Side 1	34.131mm	-
Positioning accuracy:		Less than +/- 20um, with specified test disk.	

2.5 Magnetic Head

All types.

- Magnetic head: Gimbal supported read/write head with tunnel erase
- Read/write head track width: 0.160mm nominal
- Effective track width after tunnel erase: 0.150 +/- 0.015mm
- Erase head track width: 0.100mm nominal
- Read/write-erase gap spacing: 0.85 +/- 0.05mm
- Read/write gap azimuth: 0° +/- 18' with specified test disk

1-4

Detailed Description and Servicing
Disk Drives

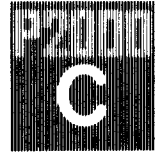

2.6 Track Seek Mechanism

All types.

Head positioning mechanism:	Band positioner
Stepping motor:	4-phase, 200 steps per rev
Stepping motor drive:	1 step per track
Outer/inner stopper:	Mechanical moving stopper
Track 00 detection:	LED and photo-transistor
Track to track time:	Less than 3msec
Settling time:	Less than 15msec (excluding track to track time)
Average track access time:	94msec (including settling time)

2.7 Head Load Mechanism

All types.

Head load mechanism:	Plunger solenoid
Head load time:	Less than 35msec
File protect mechanism:	Detection of write enable notch by LED and photo-transistor
Window margin (shipping):	More than 600nsec, with specified test disk, MFM method, PLO separator, and 0 write pre-compensation



Detailed Description and Servicing
Disk Drives

3

JUMPERS

The jumpers required for the various drives are shown below:

	FD 55A	FD 55F	FD 55A(L)	FD 55F(L)
DS	ST	WT	-	-
HM	yes	yes	yes	yes
DS0-DS3	yes	yes	yes	yes
MX	no	no	no	no
HS	no	no	no	no
PM	-	-	yes	yes
UR	-	-	no	no
ML	-	-	no	no
IU	-	-	no	no
HL	-	-	no	no
UO	-	-	no	no
U1	-	-	no	no
RE	-	-	no	no
SM	-	-	yes	yes

Detailed Description and Servicing
Disk Drives



THIS PAGE INTENTIONALLY BLANK

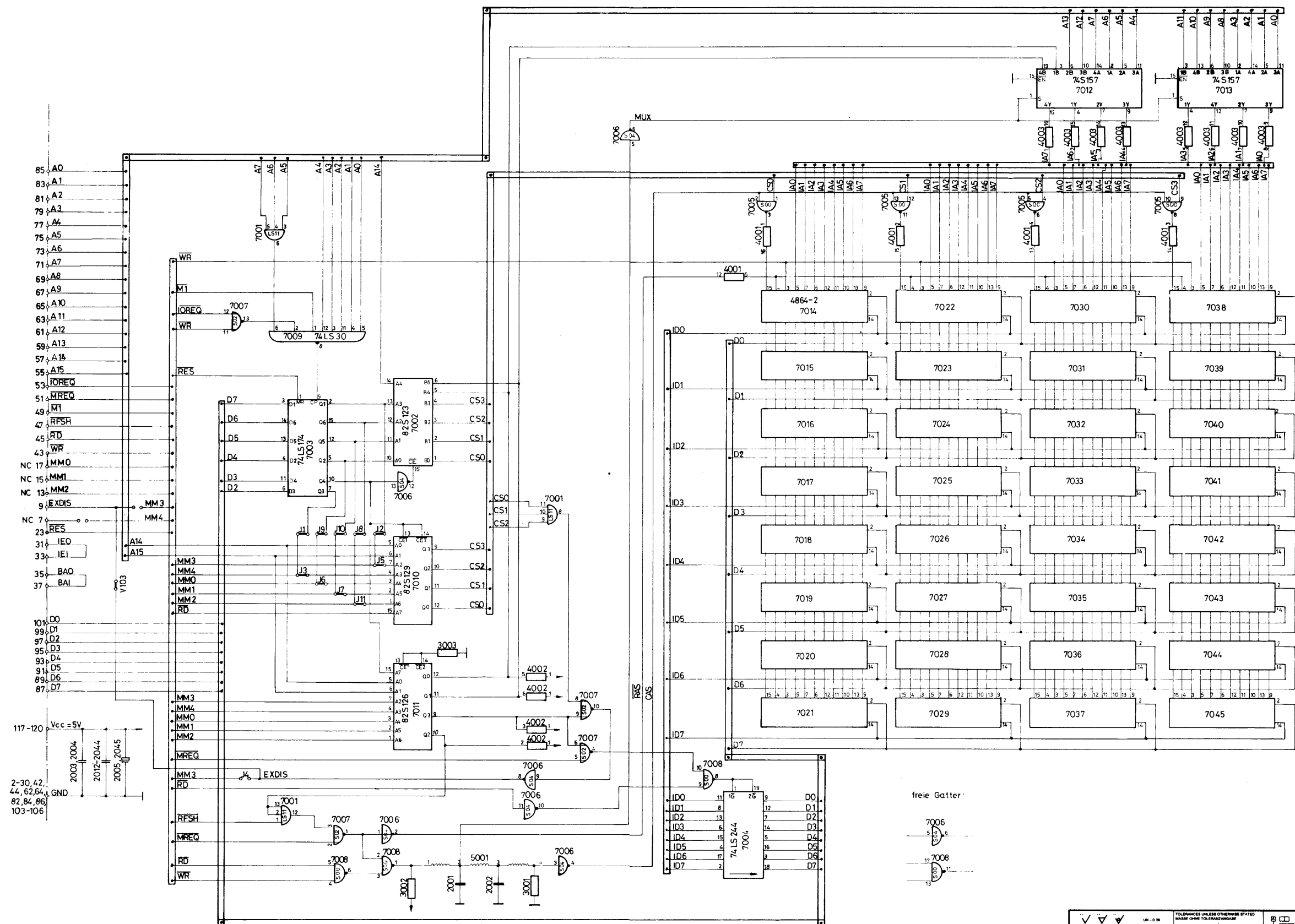

117-120 Vcc = 5V
 2003, 2004
 2012, 2044
 2005, 2045
 2-30, 42, 44, 62, 64, 82, 84, 86, 103-106 GND

freie Gatter:
 7006
 7008

TOLERANCES UNLESS OTHERWISE STATED		MAßE OHNE TOLERANZANGABE		DIMENSIONS UNLESS OTHERWISE STATED	
μm	micron	mm	mm	inch	inch
0.25	0.01	0.25	0.01	0.010	0.004
GENERAL REQUIREMENTS			ACCEPTABLE QUALITY LEVEL		
ALL DIMENSIONS ARE TO UNLESS OTHERWISE STATED			FOR ALL DIMENSIONS		
SCALE: 1:1			FOR ALL DIMENSIONS		
CLASS NO.			5103 108 0297.0		
PRINTED BOARD ASSY			Printpl., Zus. (4x 64K-RAM)		
DATE: 15.09.83			DATE: 15.09.83		
DRAWN: RENDL J			DRAWN: RENDL J		
CHECKED: 15.09.83			CHECKED: 15.09.83		

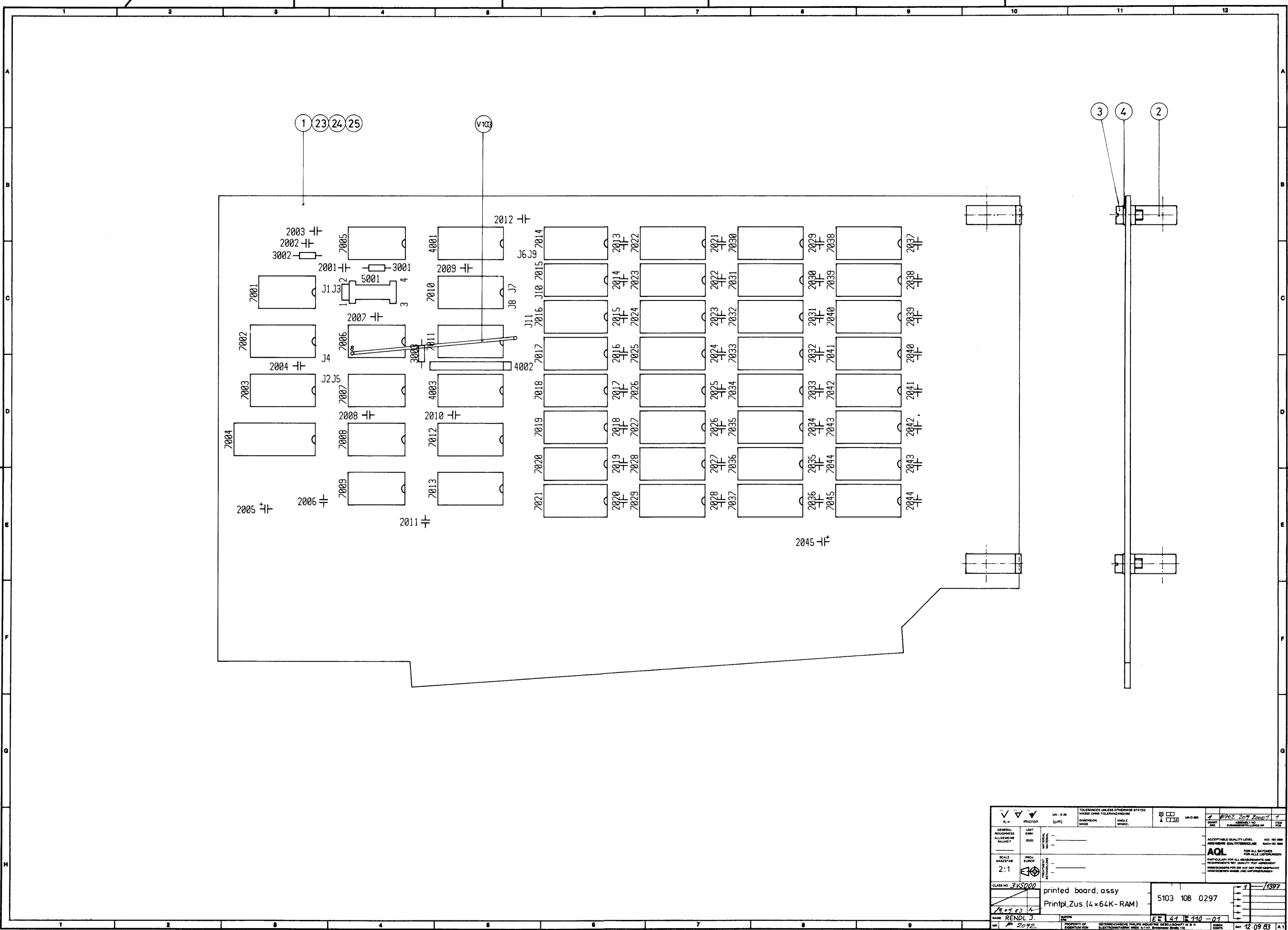

Subscriptoren

1	2	3	4	5	6	7	8	9	10	11	12
A	B	C	D	E	F	G	H				

UN - D 28	UN - D 28	UN - D 28	UN - D 28
GENERAL REQUIREMENTS ALLGEMEINE ANFORDERUNGEN	SCALE MASSSTAB	CLASS NO. Klassen-Nr.	DESCRIPTION Beschreibung
ACCEPTABLE QUALITY LEVEL ANNEHMENS WERTIGKEITENSTUFE	2:1	315000	printed board, assy Printpl. Zus. (4 x 64K - RAM)
FOR ALL BATCHES FOR ALL LIEFERUNGEN			5103 108 0297
PARTICULARLY FOR ALL REQUIREMENTS AND ANFORDERUNGEN FÜR DIE AUSGABE PRODUKTION ANFORDERUNGEN MASS UND ANFORDERUNGEN			
NAME Name	DATE Datum	PROPERTY OF EIGENTUM VON	DATE Datum
RENDL J.	2072	DERECHTSCHIEDLICH PHILIPPS UNIVERSITÄT WÜRZBURG	12.09.83

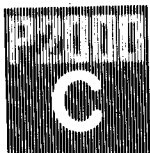

Detailed Description and Servicing
P2000C Options - Memory Extension P2092

1

GENERAL

The P2000C Memory Extension option provides the user with an additional 256K bytes of RAM, which may be used as RAM Floppy (or cache-memory). Presence of the PCB must be indicated with the use of the Configuration Program if it is to be used as RAM Floppy. *

The PCB occupies the extension socket on the Mainboard and instructions for fitting it are given in Part 4 of this manual.

When the Memory Extension is fitted, bank switching functions are carried out by the memory manager on the extension board.

2

CIRCUIT DESCRIPTION

The 256K bytes of extension memory are made up of 4 banks of 8 dynamic 4864-2 RAM's (items 7014 to 7045), which are divided into 16 segments of 16K bytes and can be selected by a decoder programmed as an output port, which also uses the memory manager signals. The memory images shown in figures 7.1 to 7.7 are possible. The values required to achieve a particular memory configuration (to be output to port FF) are given in the form "FF:=XXH". The values within the memory maps represent the BANK/SEGMENT numbers.

FF:=00H

0.3
0.2
0.1
0.0

Figure 7.1 Basic Memory Configuration

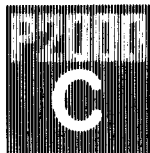

Detailed Description and Servicing
P2000C Options - Memory Extension P2092

2.1 Extension Memory Arrangement

The relationship between the Extension Memory, the Main Memory and the various modes is shown in table 7.1.

2.2 Standard Bank Switching

When not using the Memory Extension as RAM Floppy, the Standard Bank Switching Modes (MP/M, OASIS, CROMIX and WRITE ALL) are available to the user (see figures 7.3 to 7.6). These make available the sixteen segments of 16 kbytes of RAM in a variety of configurations.

Access is made to these configurations by passing the appropriate value to output port FF.

2.3 Cache Memory

In Cache Mode, the user has available 15 additional banks of memory, each covering 16 kbytes, as shown in figure 7.7. Each individual bank can be accessed by addressing the bank with:

OUT (FF), A ,
where A = the value to be sent to output port FF
(18H, 28H...F8H).

As shown in figure 7.7, certain memory locations are shared. This gives the Cache Memory the following properties:

- for each of the 15 memory banks, the lower addresses (from 0000H to 3FFFH) are common, allowing data to be effectively 'carried over' to different programs. This area is used as the directory area when the RAM Floppy is implemented.
- for each of the 15 memory banks, the upper addresses (from C000H to FFFFH) are part of the main memory, allowing data to be 'carried over' to and from main memory routines.
- for each of the 15 memory banks, the addresses from 8000H to BFFFH do not exist and any attempted access to these addresses while in the Cache Mode will give undefined results.
- for each of the 15 memory banks the 16 kbytes between 4000H and 7FFFH are available to the user. These areas are used to store files when the RAM Floppy is implemented.

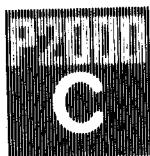

Detailed Description and Servicing
P2000C Options - Memory Extension P2092

FF:=90H	FF:=A0H	FF:=B0H	FF:=C0H	FF:=D0H	FF:=E0H
1.3	2.3	3.3	4.3	1.0	4.0
1.2	2.2	3.2	4.2	2.0	
1.1	2.1	3.1	4.1	3.0	
0.0	0.0	0.0	0.0	0.3	0.0

Figure 7.4 5.25 Additional Banks - Using OASIS Switch Mechanism

FF:=94H	FF:=A4H	FF:=B4H	FF:=C4H
1.3	2.3	3.3	4.3
1.2	2.2	3.2	4.2
1.1	2.1	3.1	4.1
1.0	2.0	3.0	4.0

Figure 7.5 4 Additional Banks - Using CROMIX Type Bank Switching



Detailed Description and Servicing
P2000C Options - Memory Extension P2092

FF:=90H	FF:=A0H	FF:=B0H	FF:=C0H	FF:=D0H	FF:=E0H
1.3	2.3	3.3	4.3	1.0	4.0
1.2	2.2	3.2	4.2	2.0	
1.1	2.1	3.1	4.1	3.0	
0.0	0.0	0.0	0.0	0.3	0.0

Figure 7.4 5.25 Additional Banks - Using OASIS Switch Mechanism

FF:=94H	FF:=A4H	FF:=B4H	FF:=C4H
1.3	2.3	3.3	4.3
1.2	2.2	3.2	4.2
1.1	2.1	3.1	4.1
1.0	2.0	3.0	4.0

Figure 7.5 4 Additional Banks - Using CROMIX Type Bank Switching



Detailed Description and Servicing
P2000C Options - Memory Extension P2092

2.1 Extension Memory Arrangement

The relationship between the Extension Memory, the Main Memory and the various modes is shown in table 7.1.

2.2 Standard Bank Switching

When not using the Memory Extension as RAM Floppy, the Standard Bank Switching Modes (MP/M, OASIS, CROMIX and WRITE ALL) are available to the user (see figures 7.3 to 7.6). These make available the sixteen segments of 16 kbytes of RAM in a variety of configurations. Access is made to these configurations by passing the appropriate value to output port FF.

2.3 Cache Memory

In Cache Mode, the user has available 15 additional banks of memory, each covering 16 kbytes, as shown in figure 7.7. Each individual bank can be accessed by addressing the bank with:

OUT (FF), A ,

where A = the value to be sent to output port FF
(18H, 28H...F8H).

As shown in figure 7.7, certain memory locations are shared. This gives the Cache Memory the following properties:

- for each of the 15 memory banks, the lower addresses (from 0000H to 3FFFH) are common, allowing data to be effectively 'carried over' to different programs. This area is used as the directory area when the RAM Floppy is implemented.
- for each of the 15 memory banks, the upper addresses (from C000H to FFFFH) are part of the main memory, allowing data to be 'carried over' to and from main memory routines.
- for each of the 15 memory banks, the addresses from 8000H to BFFFH do not exist and any attempted access to these addresses while in the Cache Mode will give undefined results.
- for each of the 15 memory banks the 16 kbytes between 4000H and 7FFFH are available to the user. These areas are used to store files when the RAM Floppy is implemented.

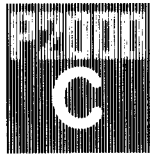

Detailed Description and Servicing
P2000C Options - Memory Extension P2092

1 GENERAL

The P2000C Memory Extension option provides the user with an additional 256K bytes of RAM, which may be used as RAM Floppy (or cache-memory). Presence of the PCB must be indicated with the use of the Configuration Program if it is to be used as RAM Floppy. *

The PCB occupies the extension socket on the Mainboard and instructions for fitting it are given in Part 4 of this manual.

When the Memory Extension is fitted, bank switching functions are carried out by the memory manager on the extension board.

2 CIRCUIT DESCRIPTION

The 256K bytes of extension memory are made up of 4 banks of 8 dynamic 4864-2 RAM's (items 7014 to 7045), which are divided into 16 segments of 16K bytes and can be selected by a decoder programmed as an output port, which also uses the memory manager signals. The memory images shown in figures 7.1 to 7.7 are possible. The values required to achieve a particular memory configuration (to be output to port FF) are given in the form "FF:=XXH". The values within the memory maps represent the BANK/SEGMENT numbers.

FF:=00H

0.3
0.2
0.1
0.0

Figure 7.1 Basic Memory Configuration

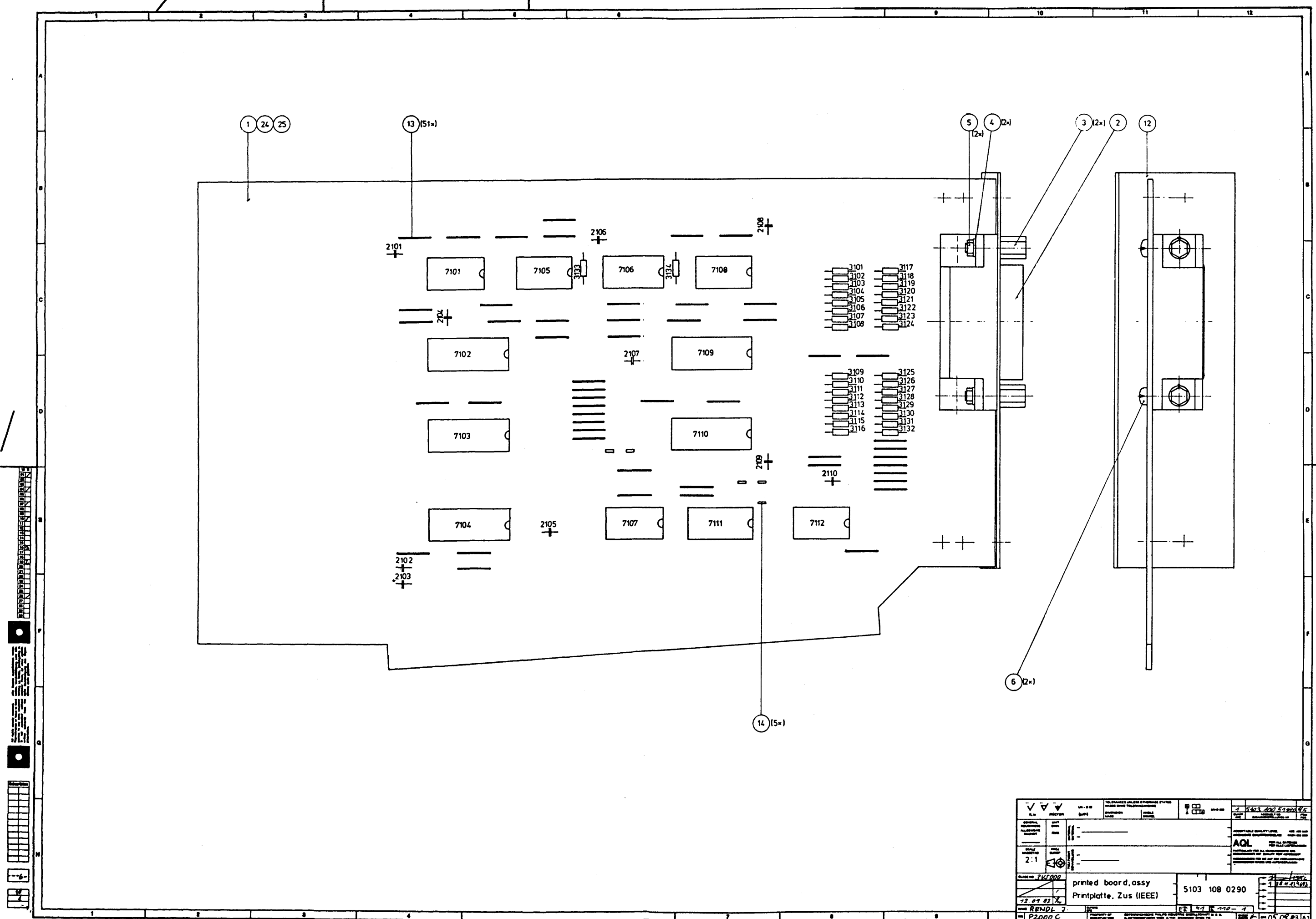

<input checked="" type="checkbox"/> 1.00 <input checked="" type="checkbox"/> 1.01 <input checked="" type="checkbox"/> 1.02 <input checked="" type="checkbox"/> 1.03 <input checked="" type="checkbox"/> 1.04 <input checked="" type="checkbox"/> 1.05 <input checked="" type="checkbox"/> 1.06 <input checked="" type="checkbox"/> 1.07 <input checked="" type="checkbox"/> 1.08 <input checked="" type="checkbox"/> 1.09 <input checked="" type="checkbox"/> 1.10 <input checked="" type="checkbox"/> 1.11 <input checked="" type="checkbox"/> 1.12 <input checked="" type="checkbox"/> 1.13 <input checked="" type="checkbox"/> 1.14 <input checked="" type="checkbox"/> 1.15 <input checked="" type="checkbox"/> 1.16 <input checked="" type="checkbox"/> 1.17 <input checked="" type="checkbox"/> 1.18 <input checked="" type="checkbox"/> 1.19 <input checked="" type="checkbox"/> 1.20 <input checked="" type="checkbox"/> 1.21 <input checked="" type="checkbox"/> 1.22 <input checked="" type="checkbox"/> 1.23 <input checked="" type="checkbox"/> 1.24 <input checked="" type="checkbox"/> 1.25 <input checked="" type="checkbox"/> 1.26 <input checked="" type="checkbox"/> 1.27 <input checked="" type="checkbox"/> 1.28 <input checked="" type="checkbox"/> 1.29 <input checked="" type="checkbox"/> 1.30 <input checked="" type="checkbox"/> 1.31 <input checked="" type="checkbox"/> 1.32 <input checked="" type="checkbox"/> 1.33 <input checked="" type="checkbox"/> 1.34 <input checked="" type="checkbox"/> 1.35 <input checked="" type="checkbox"/> 1.36 <input checked="" type="checkbox"/> 1.37 <input checked="" type="checkbox"/> 1.38 <input checked="" type="checkbox"/> 1.39 <input checked="" type="checkbox"/> 1.40 <input checked="" type="checkbox"/> 1.41 <input checked="" type="checkbox"/> 1.42 <input checked="" type="checkbox"/> 1.43 <input checked="" type="checkbox"/> 1.44 <input checked="" type="checkbox"/> 1.45 <input checked="" type="checkbox"/> 1.46 <input checked="" type="checkbox"/> 1.47 <input checked="" type="checkbox"/> 1.48 <input checked="" type="checkbox"/> 1.49 <input checked="" type="checkbox"/> 1.50 <input checked="" type="checkbox"/> 1.51 <input checked="" type="checkbox"/> 1.52 <input checked="" type="checkbox"/> 1.53 <input checked="" type="checkbox"/> 1.54 <input checked="" type="checkbox"/> 1.55 <input checked="" type="checkbox"/> 1.56 <input checked="" type="checkbox"/> 1.57 <input checked="" type="checkbox"/> 1.58 <input checked="" type="checkbox"/> 1.59 <input checked="" type="checkbox"/> 1.60 <input checked="" type="checkbox"/> 1.61 <input checked="" type="checkbox"/> 1.62 <input checked="" type="checkbox"/> 1.63 <input checked="" type="checkbox"/> 1.64 <input checked="" type="checkbox"/> 1.65 <input checked="" type="checkbox"/> 1.66 <input checked="" type="checkbox"/> 1.67 <input checked="" type="checkbox"/> 1.68 <input checked="" type="checkbox"/> 1.69 <input checked="" type="checkbox"/> 1.70 <input checked="" type="checkbox"/> 1.71 <input checked="" type="checkbox"/> 1.72 <input checked="" type="checkbox"/> 1.73 <input checked="" type="checkbox"/> 1.74 <input checked="" type="checkbox"/> 1.75 <input checked="" type="checkbox"/> 1.76 <input checked="" type="checkbox"/> 1.77 <input checked="" type="checkbox"/> 1.78 <input checked="" type="checkbox"/> 1.79 <input checked="" type="checkbox"/> 1.80 <input checked="" type="checkbox"/> 1.81 <input checked="" type="checkbox"/> 1.82 <input checked="" type="checkbox"/> 1.83 <input checked="" type="checkbox"/> 1.84 <input checked="" type="checkbox"/> 1.85 <input checked="" type="checkbox"/> 1.86 <input checked="" type="checkbox"/> 1.87 <input checked="" type="checkbox"/> 1.88 <input checked="" type="checkbox"/> 1.89 <input checked="" type="checkbox"/> 1.90 <input checked="" type="checkbox"/> 1.91 <input checked="" type="checkbox"/> 1.92 <input checked="" type="checkbox"/> 1.93 <input checked="" type="checkbox"/> 1.94 <input checked="" type="checkbox"/> 1.95 <input checked="" type="checkbox"/> 1.96 <input checked="" type="checkbox"/> 1.97 <input checked="" type="checkbox"/> 1.98 <input checked="" type="checkbox"/> 1.99 <input checked="" type="checkbox"/> 2.00		5103 108 0290 printed board,assy Printplatte, Zus (IEEE)	5103 108 0290 1 05 04 03 A1
--	--	--	--------------------------------



Detailed Description and Servicing
P2000C Options - IEEE Extension P2091

1

GENERAL

The P2000C IEEE Extension P2091 represents a low cost, degraded version of the Standard Digital Interface for Programmable Instrumentation to the IEEE Std 488-1975, and deals with the interconnection of programmable electronic measuring devices under the control of the P2000C.

The main properties of the P2000C IEEE Extension are as follows:

- Connection of up to 15 devices (in addition to the P2000C)
- A maximum overall distance between P2000C and the furthest device of 20 metres
- Byte serial data transfer dependent on software
- Multiplexing of addresses, commands and data
- 16 bus lines (8 data, 8 control - 3 for bus transfer, 5 for bus management)
- Standard codes for addresses and commands (ASCII or ISO 7 bit code)
- Transparent data transfer
- Asynchronous communication (handshake)
- Different baudrates permitted for various devices
- Low cost
- Many devices available with IEEE interfaces

Application:

- Ideal for simple instrumentation systems at medium data rates and over short distances.

This chapter describes the hardware used to provide the digital interface facility. Control of the IEEE Extension board is by software, and is described in the relevant software documentation.

Detailed Description and Servicing
P2000C Options - IEEE Extension P2091

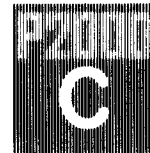

1.1 IEEE Bus Signals

The IEEE Bus Signals are defined as follows:

Eight interface signal lines (active-low), carrying all 7 bit interface messages and the device dependent messages.

- DI01 to DI08 (data input output 1) to (data input output 8)

Three interface signal lines, used to transfer each byte of data on the DIO signal lines from an addressed talker to all addressed listeners.

- DAV (data valid) indicates the condition (availability and validity) of information on the DIO signal lines.
- NRFD (not ready for data) indicates that the device(s) is(are) not ready/ready to accept data.
- NDAC (not data accepted) indicates that data has been not accepted/accepted by the device(s).

The DAV, NRFD and NDAC signal lines operate in a three-wire (interlocked) handshake process to transfer each data byte across the interface. A timing diagram and description of this process is given in section 4.

Five interface signal lines are used to manage the flow of information across the interface.

- ATN (attention) is used to specify how data on the DIO signal lines are to be interpreted and which device must respond to the data.
- IFC (interface clear) is used to place the interface system, parts of which are contained in all interconnected devices, in a known quiescent state.
- SRQ (service request) is used by a device to indicate the need for attention and to request an interruption of the current sequence of events.
- REN (remote enable) is used (in conjunction with other messages) to select between two alternate sources of device programming data.
- EOI (end or indentify) is used to indicate the end of a multiple byte transfer sequence or, in conjunction with ATN, to execute a polling sequence.



Detailed Description and Servicing
P2000C Options - IEEE Extension P2091

2

BLOCK DIAGRAM

Figure 8.1 shows the block diagram of a typical instrumentation system, showing the capability of handling a variety of instrumentation requirements.

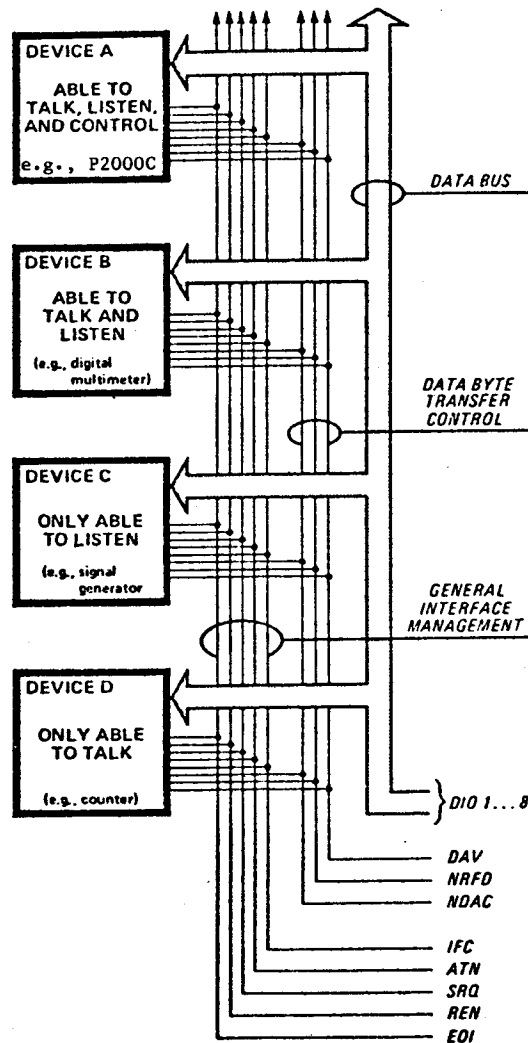
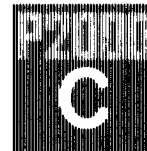

Figure 8.1 Typical Instrumentation System Using IEEE - Block Diagram

1-4

Detailed Description and Servicing
P2000C Options - IEEE Extension P2091



3

SPECIFICATION

The purpose of the IEEE board is to route signals between the P2000C and the various programmable devices, which will be connected to the Unit Under Test (UUT). These signals are used (typically) to:

- select an appropriate stimulus device
- set the output of the stimulus device
- select an appropriate measurement device
- set the range/mode of the measurement device
- pass the resultant measurement to the CPU for evaluation

This program controlled procedure will be repeated until the condition of the UUT is determined.

The IEEE Extension is built around a 16 bit parallel input/output port (output latched).

3.1

Port Addresses

R/W DI01 - DI08 - port address FF
R/W Control bus - port address FE

	Control Bus	Data Bus	
bit0	EOI	DI01	
bit1	DAV	DI02	
bit2	NRFD	DI03	
bit3	NDAC	DI04	
bit4	SRQ	DI05	
bit5	IFC	DI06	(INT)
bit6	ATN	DI07	(INT)
bit7	REN	DI08	

3.2

IEEE Interrupt

The interrupt circuit is used to indicate the high to low transition of signals IFC or ATN, using a free Z80-CTC channel to generate a Z80 interrupt (mode2). It is the responsibility of the software to correctly interpret the interrupt. The interrupt address is FFDCH.



Detailed Description and Servicing
P2000C Options - IEEE Extension P2091

3.3 Connection to Mainboard

The following connections to the 120 pin Bus Extension are used by the IEEE board:

Pin	Signal	Direction	Pin	Signal	Direction
13	EINT-N	IN	81	AB2	OUT
23	RES	OUT	83	AB1	OUT
43	WRB-N	OUT	85	AB0	OUT
45	RDB-N	OUT	87	D7	BI
49	M1B-N	OUT	89	D6	BI
53	IORQB-N	OUT	91	D5	BI
71	AB7	OUT	93	D4	BI
73	AB6	OUT	95	D3	BI
75	AB5	OUT	97	D2	BI
77	AB4	OUT	99	D1	BI
79	AB3	OUT	101	D0	BI

Pins 103, 105 are connected to GND
Pins 117, 119 are connected to +5V
All other odd pins are not connected
All even pins 2 - 106 are not connected

The data bus is buffered.

3.4 IEEE Bus

One transceiver circuit is reserved for each bus line. All transceivers are open collector, driving 48mA maximum. The receivers have TTL inputs with hysteresis. Each signal line is locked with two resistors, 3kOhm to +5V and 6.2kOhm to ground. A logic one (high) on the system bus forces a logic true (low) on the IEEE bus. Activating port FE, bit 5 or 6, causes an immediate interrupt.

1-6

Detailed Description and Servicing
P2000C Options - IEEE Extension P2091

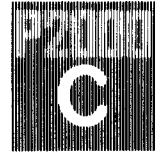

3.5 External Connections

The external IEEE Extension connections are as follows:

Pin	Signal	Pin	Signal
1	DIO1	13	DIO5
2	DIO2	14	DIO6
3	DIO3	15	DIO7
4	DIO4	16	DIO8
5	EOI	17	REN
6	DAV	18	GND, (6)
7	NRFD	19	GND, (7)
8	NDAC	20	GND, (8)
9	IFC	21	GND, (9)
10	SRQ	22	GND, (10)
11	ATN	23	GND, (11)
12	Shield	24	GND, (Logic)

3.5.1 MOUNTING

Pin designation of the IEEE Extension connector is as shown below, using connector CHAMP AMP No. 552791-2:

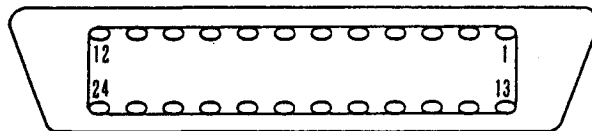

3.5.2 CIRCUIT DIAGRAM

For the circuit diagram of the IEEE board P2091, please refer to the main circuit diagrams.



Detailed Description and Servicing
P2000C Options - IEEE Extension P2091

4 CIRCUIT DESCRIPTION

4.1 IEEE Selection

The IEEE board is selected by the use of Address lines A1 to A7 and the signal M1-N, via a gate (item 7107). The output of this gate is multiplexed (items 7111/7112) with the signals IORQ-N, WR-N, RD-N and Address line A0 to produce the chip select signals for the output latches and input buffers.

4.2 IEEE Output

Information (in the form of data or control signals) is held in the bi-directional latch (item 7104). The two output latches (items 7103/7110) will feed this information onto either the IEEE data lines or control lines, depending on the chip select signal, via open collector drivers (items 7101/7105/7106/7108).

4.3 IEEE Input

Information returned from the external instrumentation system is buffered and fed (via item 7104) to the P2000C data bus. The selection between the data buffer (item 7109) and the control buffer (item 7102) is determined by the chip select signal. An external interrupt (EXTINT-N) is generated when signal lines IFC (Interface Clear) and ATN (Attention) are active, via item 7112.

4.4 Line Termination

All 16 lines are terminated, on the IEEE board, with 3k to 5V and 6.2k to ground.

4.5 Test Points

Five test points are available (TP1 to TP5) on the IEEE board, giving access to the chip select signals for the board and the data and control input/output devices.

Detailed Description and Servicing
P2000C Options - IEEE Extension P2091

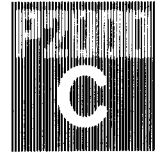

4.6 Handshake Timing

The handshake process is used to control the transfer of all data between talker and listener.

Figure 8.2 shows this process by illustrating the waveforms on the DAV, NRFD and NDAC signal lines. NRFD and NDAC represent composite signals where two or more listeners accept the same data byte at slightly differing times. The annotated numbers on the timing diagram are explained below.

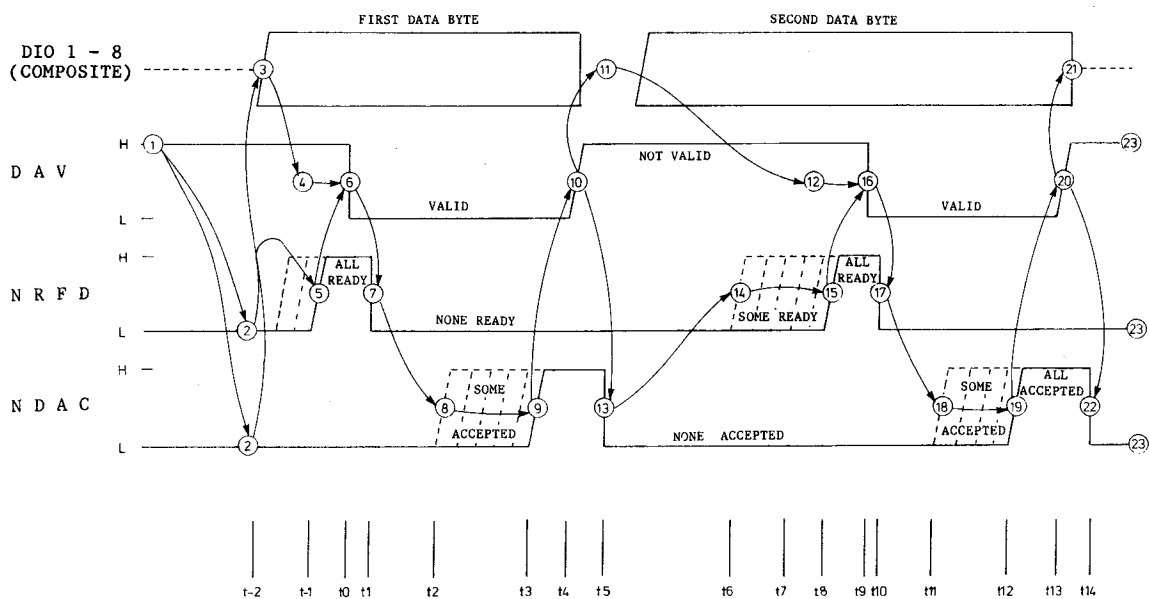

Figure 8.2 IEEE Extension - Handshake Timing

- (1) Source initializes DAV to high (H) (data not valid).
- (2) Acceptors initialize NRFD to low (L) (none are ready for data), and set NDAC to low (L) (none have accepted the data).
- (3) $t-2$ Source checks for error condition (both NRFD and NDAC high), then sets data byte on DIO lines.
- (4) $t-2$ to t_0 Source delays to allow data to settle on DIO lines.
- (5) $t-1$ All acceptors have indicated readiness to accept first data byte: NRFD goes high.
- (6) t_0 When source senses NRFD high it sets DAV low to indicate valid and settled data on line.



Detailed Description and Servicing
P2000C Options - IEEE Extension P2091

- (7) t1 First acceptor sets NRFD low to indicate that it is no longer ready, then accepts the data. Other acceptors follow at their own rates.
- (8) t2 First acceptor sets NDAC high to indicate that it has accepted the data. (NDAC remains low due to other acceptors).
- (9) t3 Last acceptor sets NDAC high to indicate that it has accepted data, and line goes high.
- (10) t4 Source senses NDAC high, sets DAV high. This indicates to acceptors that data on DIO lines can no longer be considered valid.
- (11) t4 to t7 Source changes data on the DIO lines.
- (12) t7 to t9 Source delays to allow data to settle on the DIO lines.
- (13) t5 Acceptors sense DAV high (at 10) and set NDAC low in preparation for next cycle. NDAC goes low as the first acceptor sets the line low.
- (14) t6 First acceptor indicates that it is ready for next data byte by setting NRFD high. (NRFD remains low due to other acceptors not yet ready).
- (15) t8 Last acceptor indicates that it is ready for the next data byte by setting NRFD high: NRFD signal line goes high.
- (16) t9 Source senses NRFD high and sets DAV low to indicate valid and settled data on DIO lines.
- (17) t10 First acceptor sets NRFD low to indicate that it is no longer ready, then accepts the data.
- (18) t11 First acceptor sets NDAC high to indicate that it has accepted the data .. as in (8).
- (19) t12 Last acceptor sets NDAC high to indicate that it has accepted the data .. as in (9).
- (20) t13 Source senses NDAC high, sets DAV high .. as in (10).
- (21) Source removes data byte from DIO signal lines after setting DAV high.
- (22) t14 Acceptors sense DAV high and set NDAC low in preparation for next cycle.
- (23) Note that all three handshake lines are at their initialized states .. as in (1) and (2).

1-10

Detailed Description and Servicing
P2000C Options - IEEE Extension P2091



THIS PAGE INTENTIONALLY BLANK



Servicing
Removal and Replacement of Assemblies and Units

1

GENERAL

This chapter gives details of the recommended methods of removing and replacing assemblies and units of the P2000C.

W A R N I N G

ALWAYS REMOVE THE MAINS CONNECTOR FROM THE
REAR OF THE UNIT BEFORE ATTEMPTING TO REMOVE
COVER OR TO CARRY OUT ANY SERVICING ON THE
P2000C

2

THE COVER

The cover must be removed to gain access to all assemblies and units of the P2000C.

To remove the cover, first ensure that the:

- power cable is disconnected (safety wait time)
- keyboard and any other peripherals are disconnected
- diskettes are removed (from drives and storage compartment)
- carrying strap is removed

Remove the four screws labelled (A) in View 1.

Carefully remove the cover, taking care not to damage any of the screening springs.

Before refitting the cover, make sure that all wiring is in good order and cannot become trapped.

Servicing
Removal and Replacement of Assemblies and Units

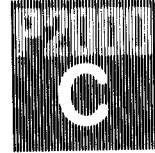

The following paragraphs assume the cover to be removed, and describe removal and refitting of:

- Terminalboard
- Mainboard
- flexible disk drives
- monitor
- power supply unit
- mains switch
- mains socket
- distribution board
- keyboard cable assembly(internal)
- optional boards (IEEE or RAM-BOARD)

3 MAINBOARD AND TERMINALBOARD

These two PCB's are fitted to a sub-chassis, which must be removed to gain access to either board.

If the Mainboard is to be replaced, remove the rear mask as described in 3.2.

Remove the three screws labelled (A) in View 2 and loosen the four screws labelled (A) in View 3. The sub-chassis can then be withdrawn slightly as shown in View 3, and removed after disconnecting the five mini-match connectors, the connectors to the disk drives and then the sixth mini-match connector.

Reverse the above order when refitting the sub-chassis.

3.1 Terminalboard

Disconnect the link between the two PCB's. Remove the four retaining screws and lock washers labelled (A) in View 4. Slide PCB off of retaining lugs and remove.

Reverse the above order when refitting the PCB, not forgetting the lock washers - which also have an electrical bonding function.



Servicing
Removal and Replacement of Assemblies and Units

3.2 Mainboard

Disconnect the link between the two PCB's.
Remove the six x-point screws labelled (B) in View 2 and remove the rear mask.
Remove the three screws labelled (A) in View 5.
The PCB can then be removed.

Reverse the above order when refitting, ensuring that the lock washer is replaced between the chassis and the earth tags.

4 FLEXIBLE DISK DRIVES

Remove the strengthening strip by removing the three screws labelled (B) in View 3 and loosening the two screws labelled (C) in View 3.

Ensure that the drive levers are in the closed (down) position.
Remove the retaining clips labelled (A) in View 6.
Remove the cover plate labelled (B) in View 6.
The two drives can then be removed. Disconnect the signal connectors and power connectors as the drives are withdrawn.

The P2000C disk drives are supplied without the locating pins, labelled (A) in View 7. Ensure that these items are removed before returning the drive for servicing.

Reverse the above order when refitting the drives.

4.1 Jumpers and Pull Up Resistors

The P2000C is capable of driving up to four 5¼" disk drives, two internal and two external.

View 7 shows the pull-up resistance network, labelled (B), which must be fitted to the last drive in the chain. If external drives are used, the last drive in the external chain must also be fitted with a pull-up resistance network.

Servicing
Removal and Replacement of Assemblies and Units

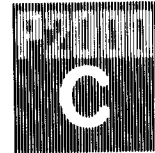

Drive addresses and head load conditions are selected by the jumpers on the PCB's, as shown in View 7 (labelled C).

Three jumpers must be fitted to each drive:

- HM: to select Head Load with Motor On
- DS: DS0 - DS3 to define drive number, where:
 - DS0 = Drive 1
 - DS1 = Drive 2
 - DS2 = Drive 3
 - DS3 = Drive 4
- DS(ST/WT): to define the track density, with:
 - ST for 48tpi
 - WT for 96tpi

This jumper must correspond to the properties of the particular drive.

5

MONITOR**HIGH VOLTAGE WARNING**

**HIGH VOLTAGES HAVE BEEN USED IN THIS UNIT
AND MAY STILL BE PRESENT AFTER SWITCH OFF**

Remove the strengthening strip by removing the three screws labelled (B) in View 3 and loosening the two screws labelled (C) in View 3.

Remove the F/D power cable from the clips at the rear of the monitor, labelled (A) in View 8.

Disconnect the video connector at the rear of the monitor, labelled (B) in View 8.

Remove the two screws labelled (D) in View 3.

Lift the monitor out, taking care not to damage the surrounding wiring.

Reverse the above order when refitting the monitor, noting the locating pins close to the two fixing points. Ensure that all cables are replaced in the cable clips.



Servicing
Removal and Replacement of Assemblies and Units

6

FRONT MASK

In order to replace the power supply and associated items it is necessary to remove the front mask.

Loosen the four screws labelled (E) in View 3 and remove the screw labelled (B) in View 1.

Ease the mask forward and carefully unclip the Power Distribution Panel as shown in View 9 (start with the clip nearest the power LED).

The mask is then free.

Reverse the above order when refitting the front mask.

7

POWER SUPPLY UNIT

Remove the strengthening strip by removing the three screws labelled (B) in View 3 and loosening the two screws labelled (C) in View 3.

Remove the front mask as described in paragraph 6.

Loosen the two screws labelled (F) in View 3, and lift the unit out of its supports. Remove the two connectors.

Reverse the above order when refitting the power supply unit, ensuring that the unit is firmly seated in the support lugs labelled A in view 11 and that the wiring will be clear of the distribution board.

7.1

Fuse Replacement

It is necessary to remove the power supply unit to gain access to the fuse holder.

Servicing
Removal and Replacement of Assemblies and Units

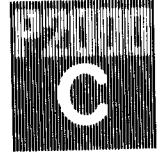

8

MAINS SWITCH

Remove the Power Supply Unit as described in paragraph 7.
Remove the switch cap.
Remove the upper two screws labelled (B) in View 11, which hold the switch to the bracket.
Note: The two lower screws are preset to align the switch with the front mask and should not need adjusting.
Unsolder the switch connections.

Reverse the above order when refitting the switch.

9

MAINS SOCKET

Remove the Power Supply Unit as described in paragraph 7.
Unsolder the mains socket connections.
Remove the two screws labelled (C) in view 11 securing the socket and the earth tag labelled (D) in view 11.

Reverse the above order when refitting the socket.

10

DISTRIBUTION PANEL

Remove the Monitor as described in paragraph 5.
Remove the Power Supply Unit as described in paragraph 7.
Disconnect the Distribution Panel connectors.

Reverse the above order when refitting the Distribution Panel.

11

KEYBOARD CABLE ASSEMBLY (INTERNAL)

Remove the front mask as described in paragraph 6.
The removal of the cable assembly will be simplified by the removal of the Monitor as described in paragraph 5.
Remove the cable strap labelled (E) in View 11.
Remove the two screws labelled (F) in View 11.
Pass the keyboard socket inside the P2000C and disconnect the other end from the Terminalboard (7 way mini-match connector).

Reverse the above order when refitting the Keyboard Cable Assembly, ensuring that a new cable strap is fitted.



Servicing
Removal and Replacement of Assemblies and Units

12 TILT-BAR

Remove the six screws labelled (C) and the single screw labelled (B) in View 1.
Ease off the bottom plate.
The tilt-bar can now be removed.

Reverse the above order when refitting the tilt-bar.

13 OPTIONAL PCB's (IEEE OR RAM FLOPPY)

One of two optional PCB's may be fitted to the extension connector on the Mainboard. The following procedure is recommended for fitting these boards:

Remove the sub-chassis as detailed in paragraph 3.

Remove the strengthening strip by removing the three screws labelled (B) in View 3 and loosening the two screws labelled (C) in View 3.

Remove the Monitor as detailed in paragraph 5.

Fit the optional board into the extension socket on the Mainboard.

- In the case of the IEEE board, the blanking plate labelled (B) in View 5 will be replaced with the IEEE socket plate.
- In the case of the RAM FLOPPY board, the brackets on the PCB must be fixed by two screws to the blanking plate.

Replace the sub-chassis, using the slots in the underside of the cable clamps to locate the top of the optional board as shown in View 10, and remake all connections.

Note: Extreme care must be taken to protect components on the board when refitting a sub-chassis which incorporates an optional PCB.

Refit the Monitor, strengthening strip and cover.

Servicing
Removal and Replacement of Assemblies and Units

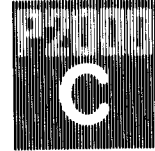
KEYBOARD

The keyboard contains one PCB, which holds the keyboard electronics and the keys. To gain access to the PCB, remove the three screws from the back of the keyboard housing and remove the top-cover.

This may be achieved by pressing down firmly on the three points labelled (X) in View 12 (one at a time) with the thumb. At the same time, lift the front of the keyboard top-cover with the finger-nails and ease the back of the top-cover up slightly and pull backwards with the other hand. The pressure applied to the casing must be in a curving movement from front to back of the unit. The PCB is secured by a groove in the front and two screws at the back.

Reverse the above order when refitting the cover, ensuring that the keyboard connector is correctly positioned. When refitting the PCB, ensure that it is firmly seated in the locating groove.



Servicing
Removal and Replacement of Assemblies and Units

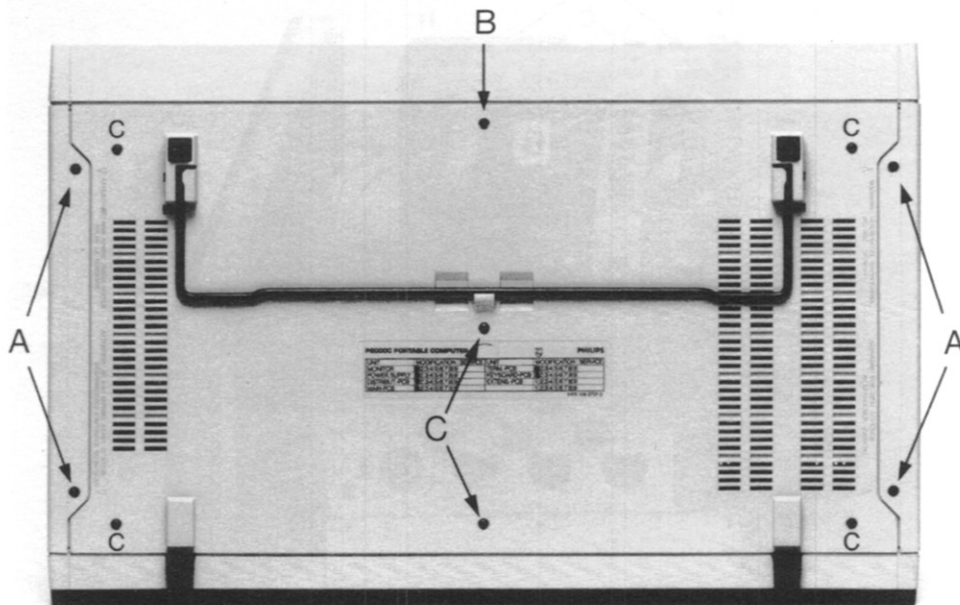

P2000C Part Replacement - View 1

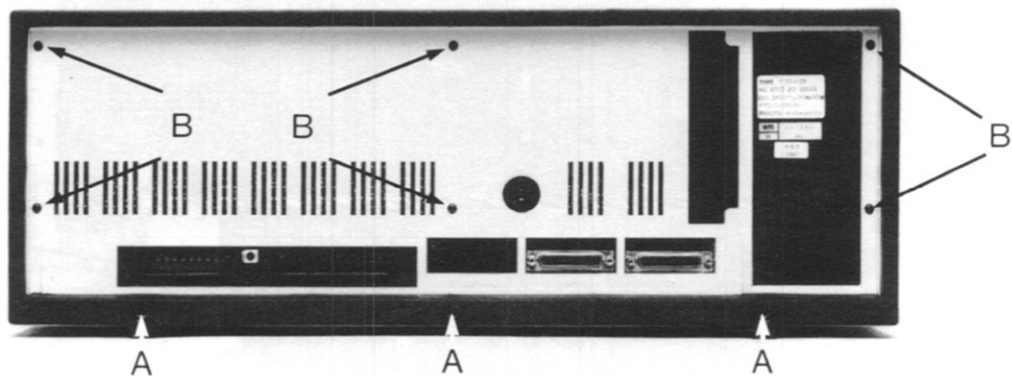

P2000C Part Replacement - View 2



Servicing
Removal and Replacement of Assemblies and Units

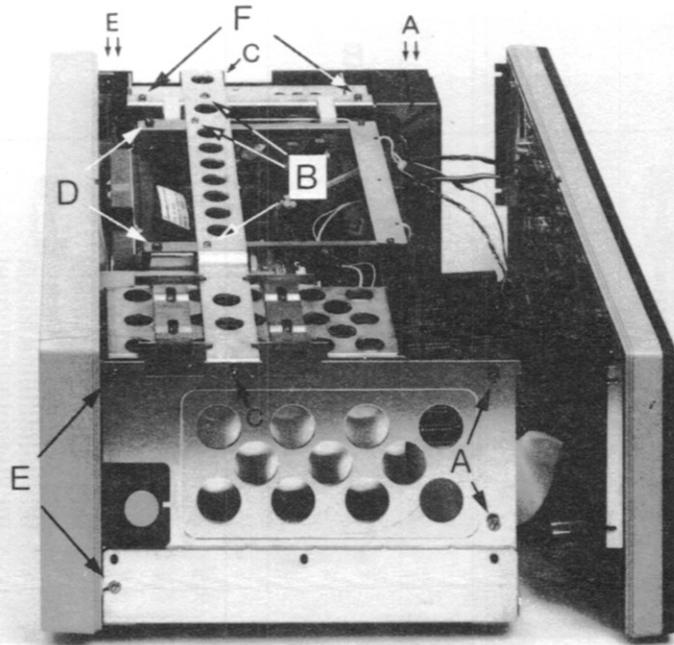

P2000C Part Replacement - View 3

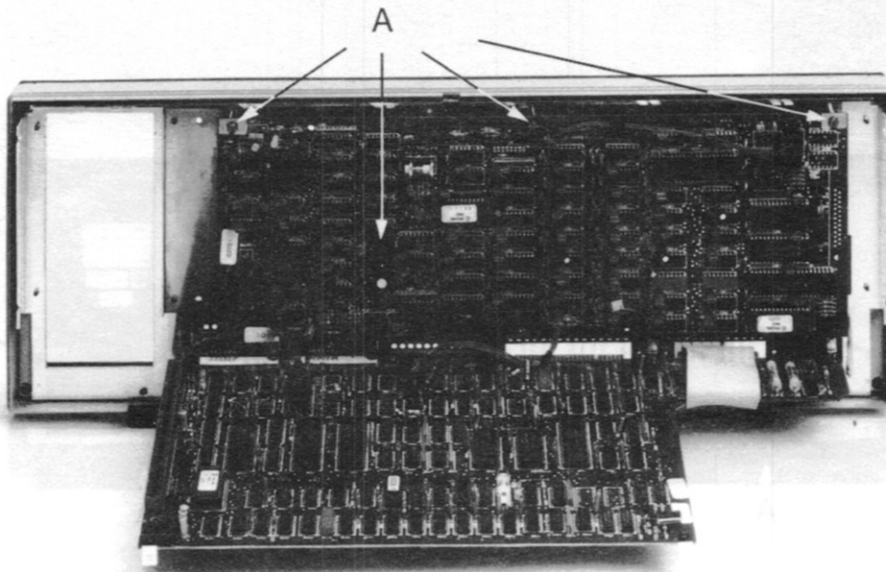

P2000C Part Replacement - View 4



Servicing
Removal and Replacement of Assemblies and Units

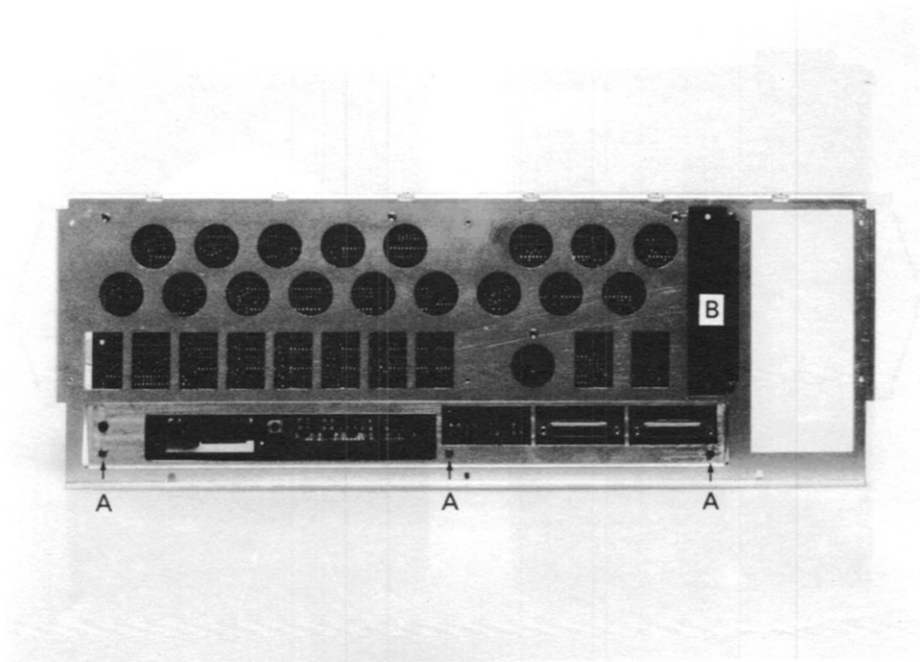

P2000C Part Replacement - View 5

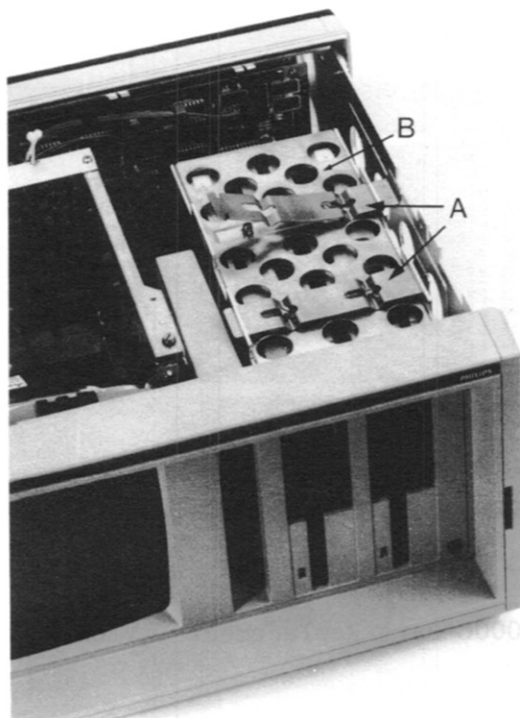

P2000C Part Replacement - View 6



Servicing
Removal and Replacement of Assemblies and Units

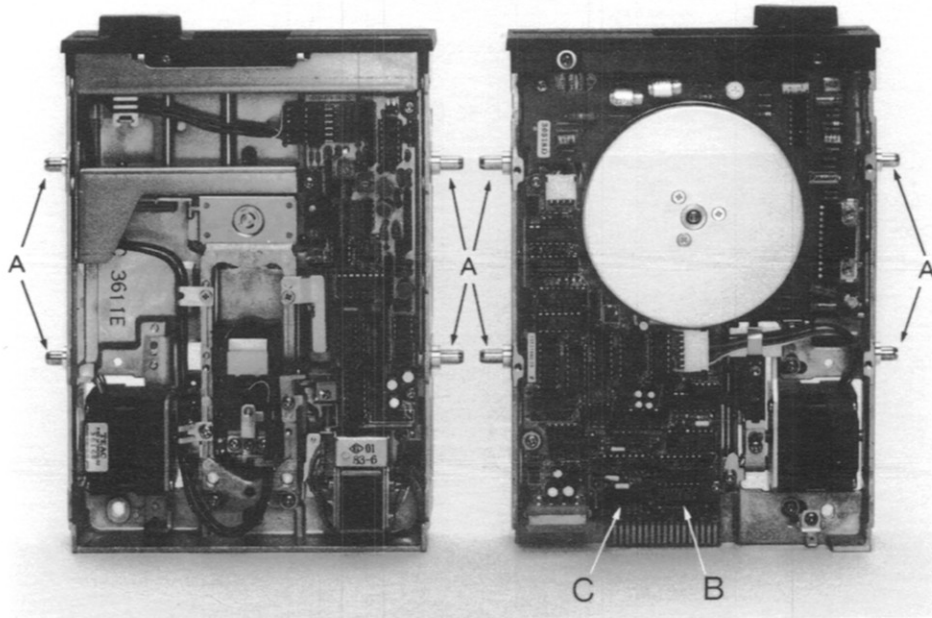

P2000C Part Replacement - View 7

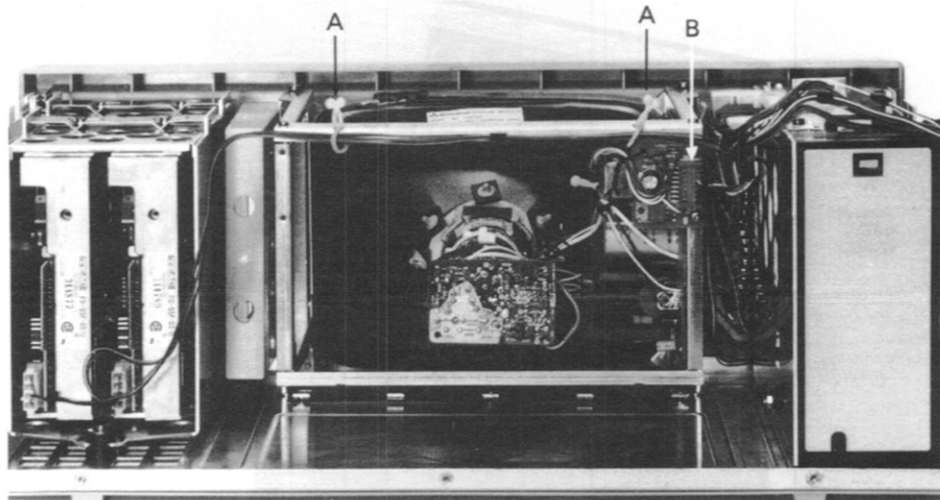

P2000C Part Replacement - View 8



Servicing
Removal and Replacement of Assemblies and Units

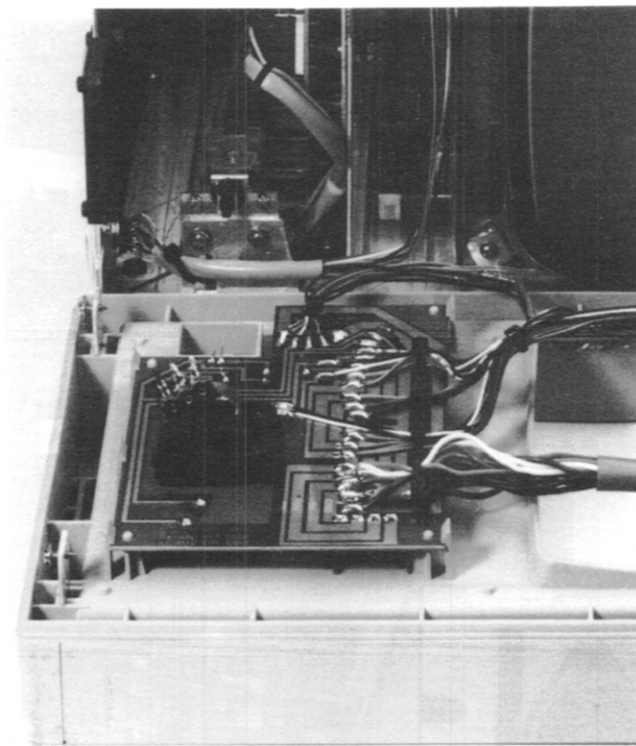

P2000C Part Replacement - View 9

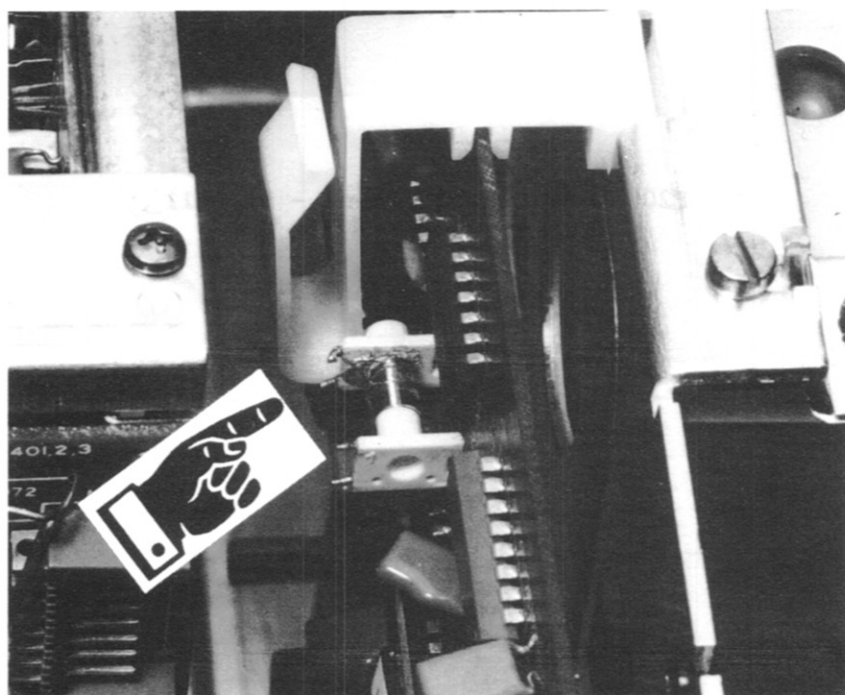

P2000C Part Replacement - View 10

Servicing
Removal and Replacement of Assemblies and Units

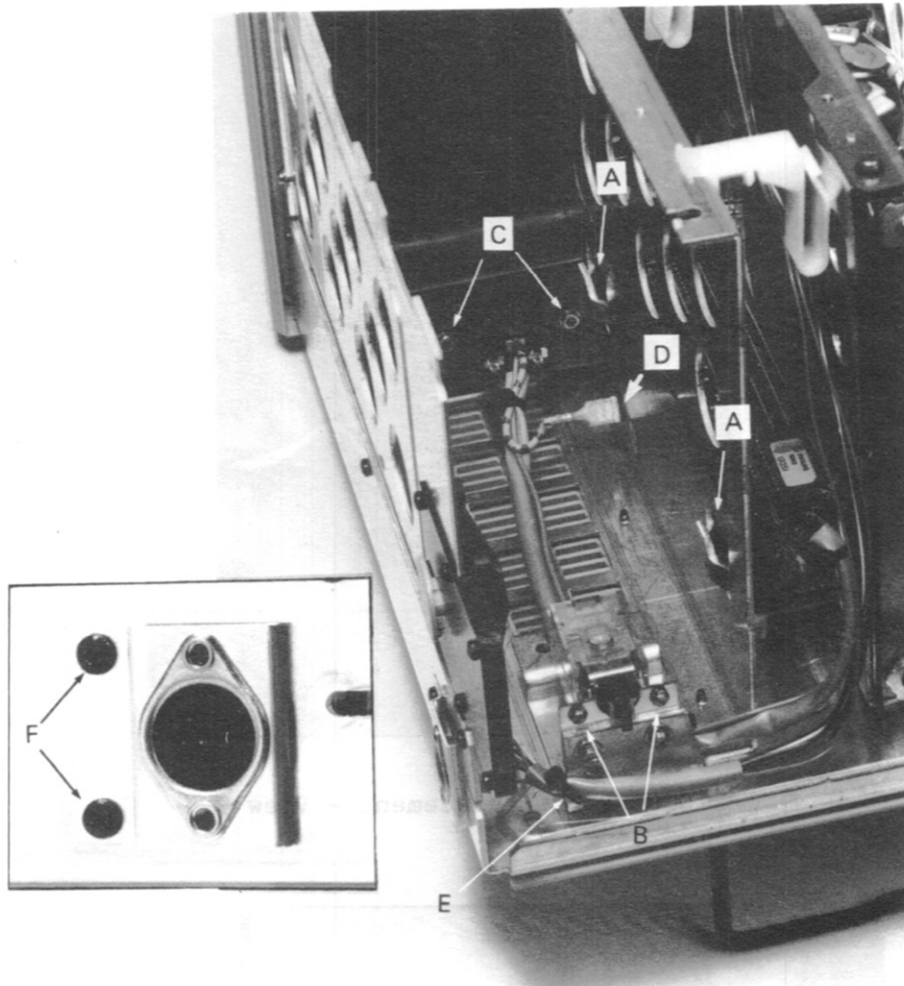

P2000C Part Replacement - View 11



Servicing
Removal and Replacement of Assemblies and Units



P2000C Part Replacement - View 12



P2000C Part Replacement - View 13

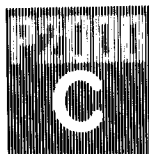

Servicing
Component Location

1 GENERAL

The following diagrams show the location of components relating to the functional blocks described in Part 3. Each diagram will be annotated with the heading and page number of the first page of the section describing it. Components that are used exclusively for a function are shown with darker shading; the lighter shading indicates partial or peripheral use of the component.

1.1 Mainboard

CPU	4.1 2-3
DMA	4.1 2-3
Data Buffers	4.1 2-4
Clock Generator	4.1 2-4
I/O Decoder	4.1 2-5
Memory Manager	4.1 2-5
Random Access Memory	4.1 2-6
IPL ROM	4.1 2-6
SAS Interface	4.1 2-7
Flexible Disk Controller	4.1 2-7
Baud Rate Generator - CTC	4.1 2-8
Serial Interface	4.1 2-8

1.2 Terminalboard

CPU	4.1 2-9
CRTC	4.1 2-9
Timing	4.1 2-10
RAM Banks	4.1 2-10
Address Multiplexer	4.1 2-11
Data Buffer	4.1 2-11
Shift Register	4.1 2-12
Attribute Mixing	4.1 2-12
Character Generator ROM	4.1 2-13
CTC	4.1 2-13
V24/Internal Interfac	4.1 2-14
Address Decoder	4.1 2-14
Keyboard Logic	4.1 2-15

Detailed Description and Servicing
Component Location

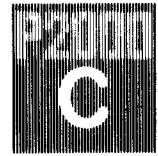

THIS PAGE INTENTIONALLY BLANK



Servicing Component Location

Mainboard - CPU 3.2 / 2-1

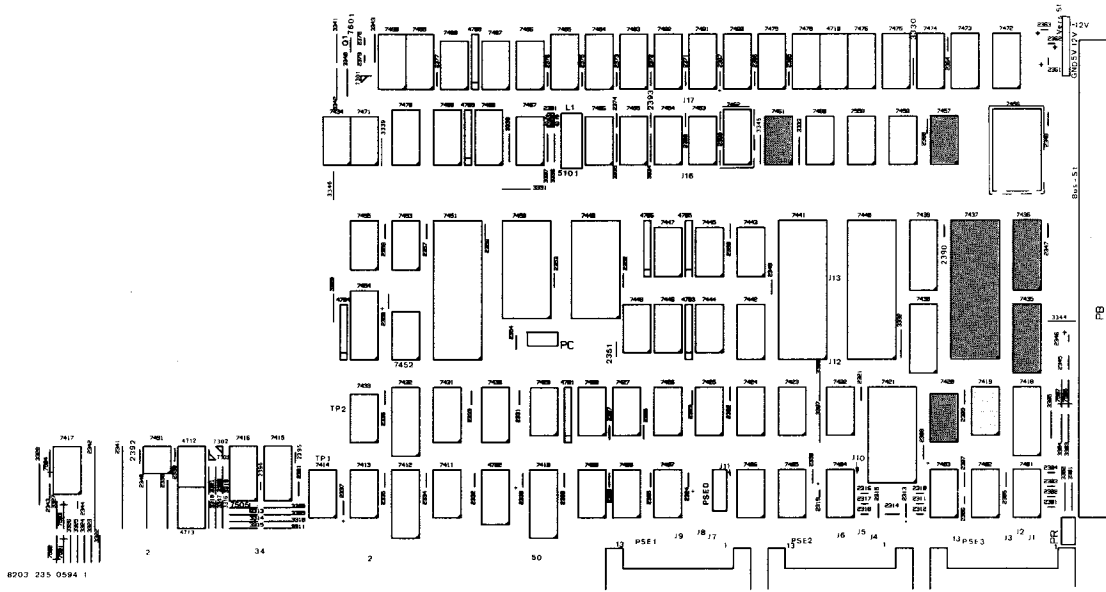

Mainboard - DMA 3.2 / 3-1

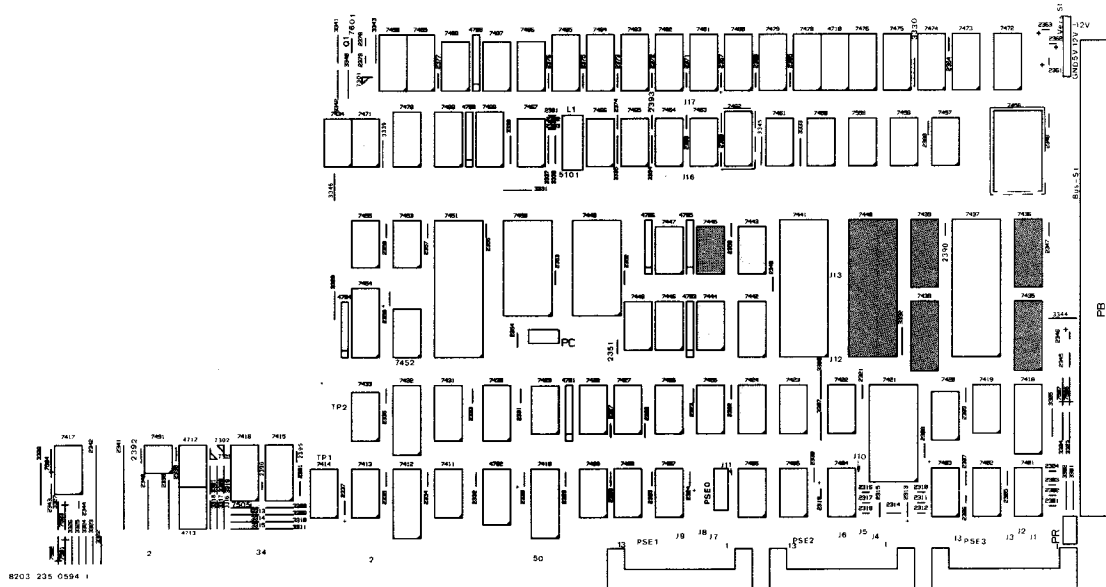

Servicing Component Location



Mainboard - Data Buffers 3.2 / 4-1

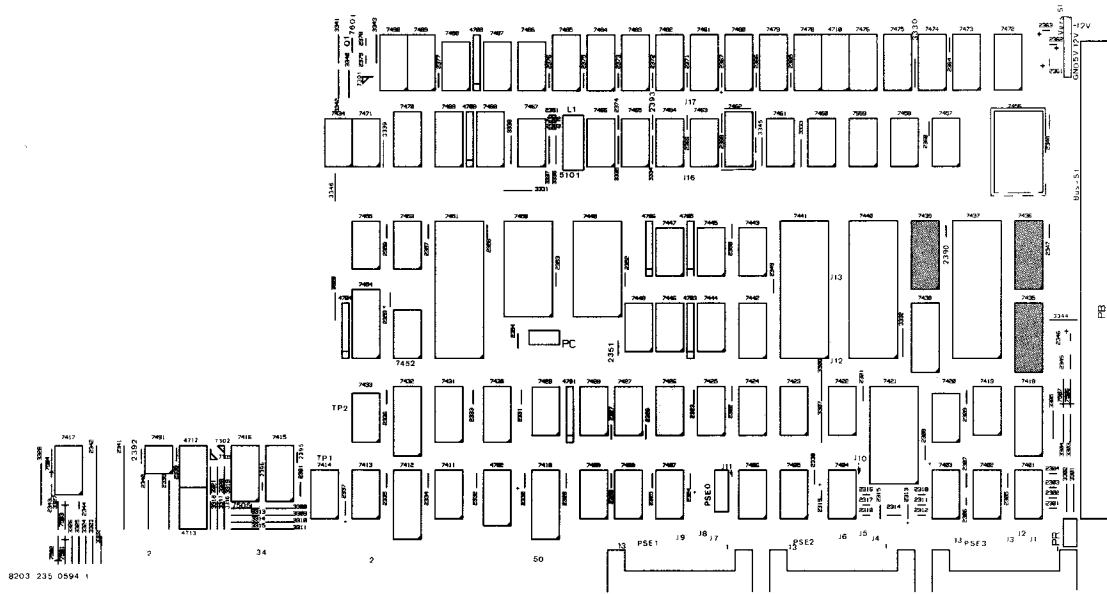

Mainboard - Clock Generator 3.2 / 5-1

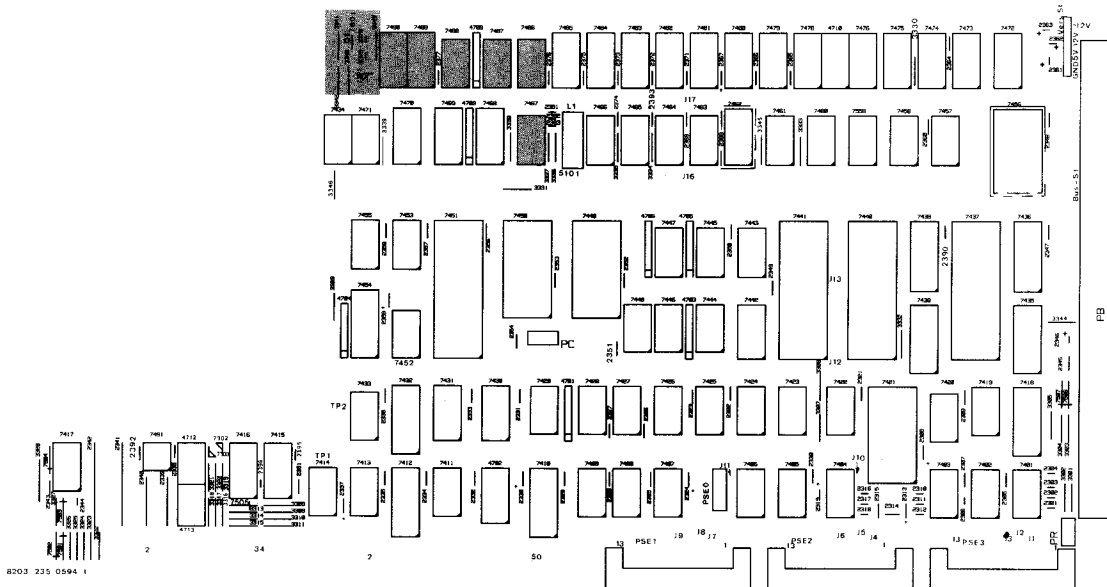

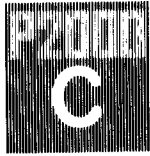

Servicing Component Location

Mainboard - I/O Decoder 3.2 / 6-1

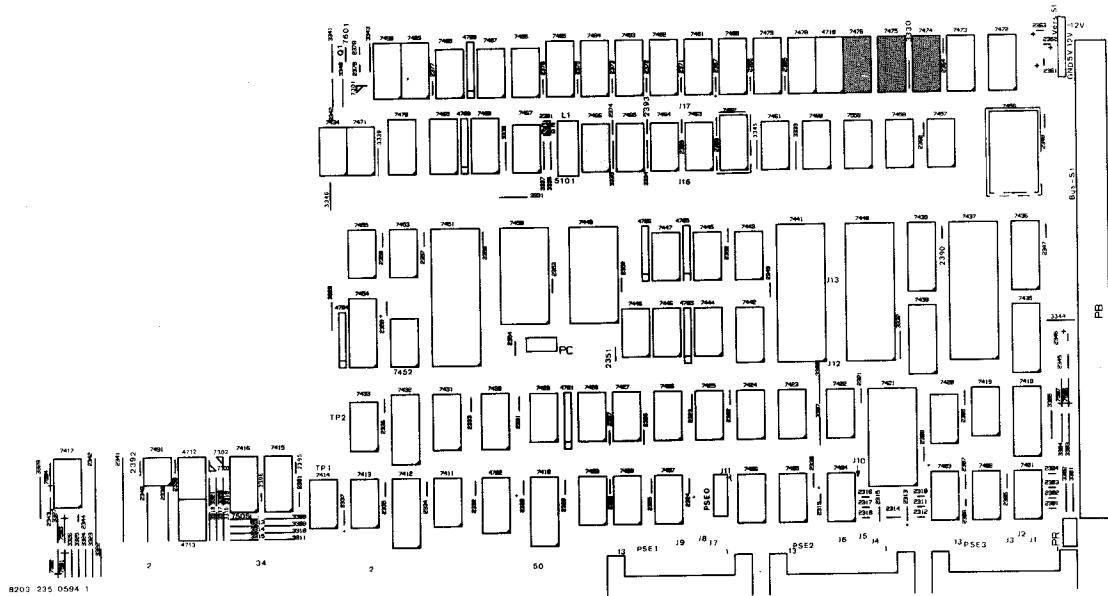

Mainboard - Memory Manager 3.2 / 7-1

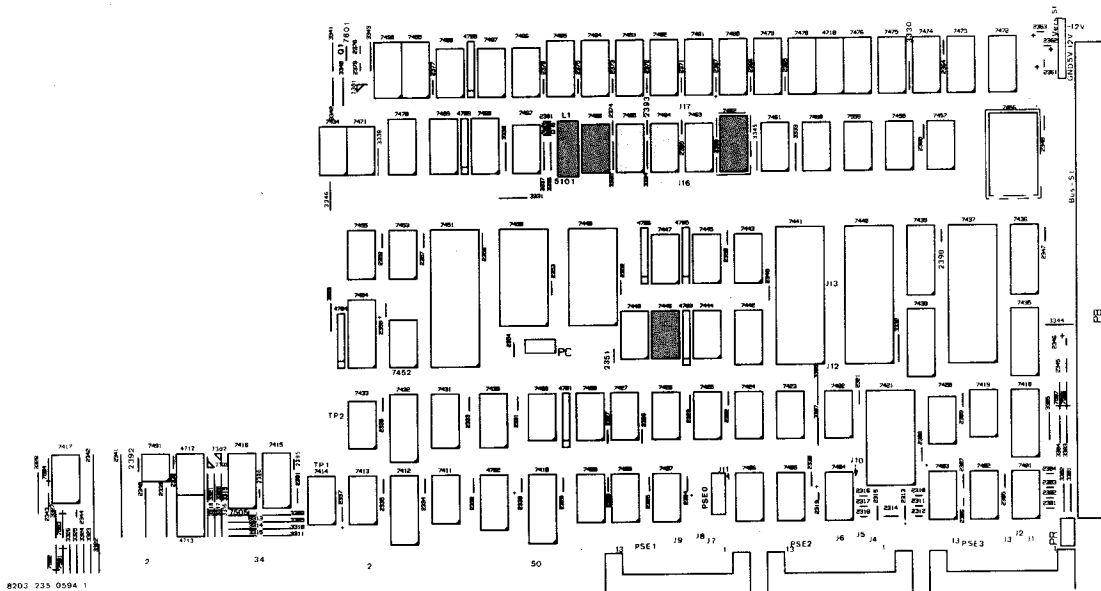

Servicing
Component Location

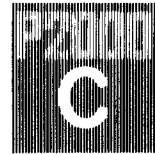

Mainboard - Random Access Memory 3.2 / 8-1

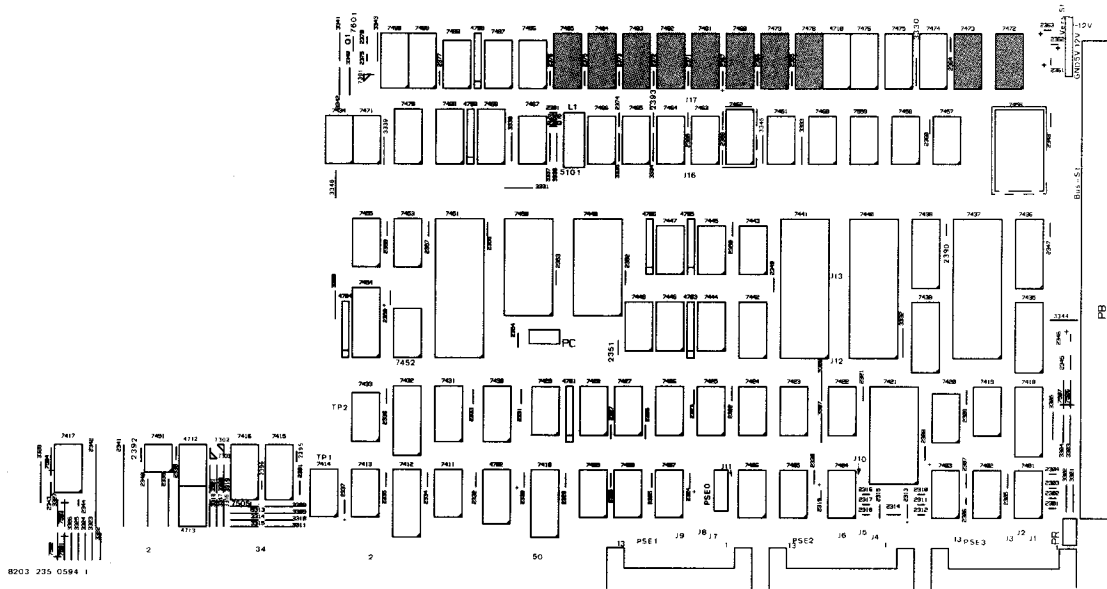

Mainboard - IPL ROM 3.2 / 9-1

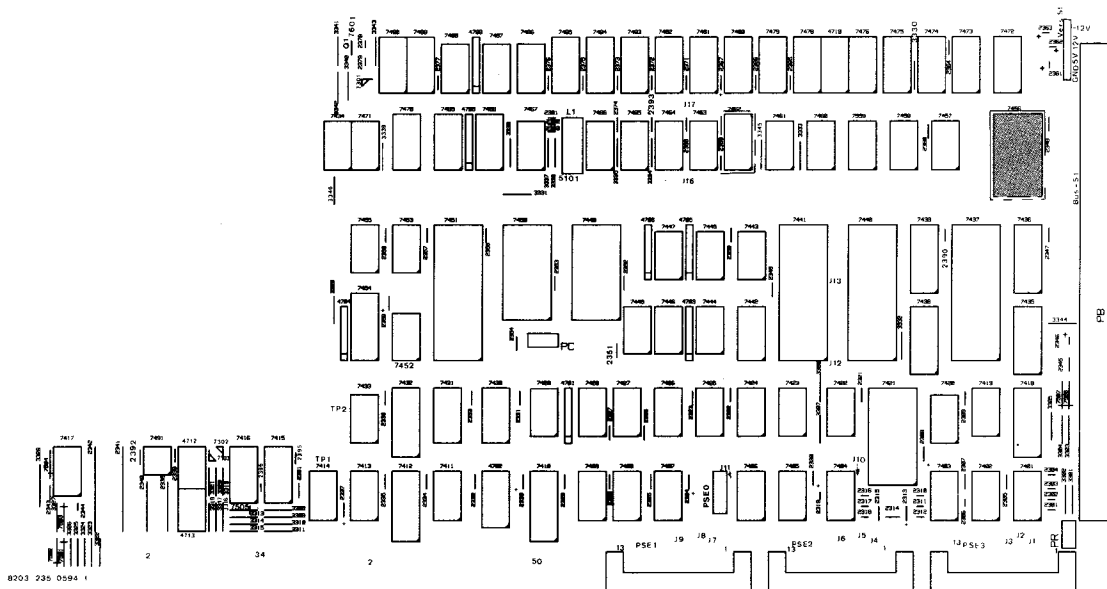



Servicing Component Location

Mainboard - SAS Interface 3.2 / 10-1

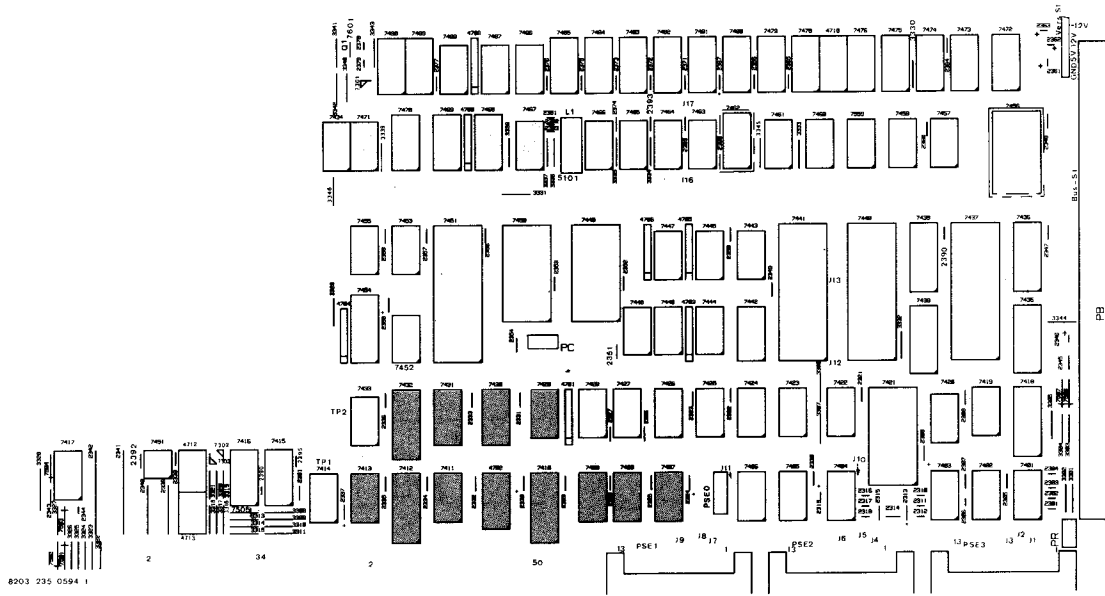

Mainboard - Flexible Disk Controller 3.2 / 11-1

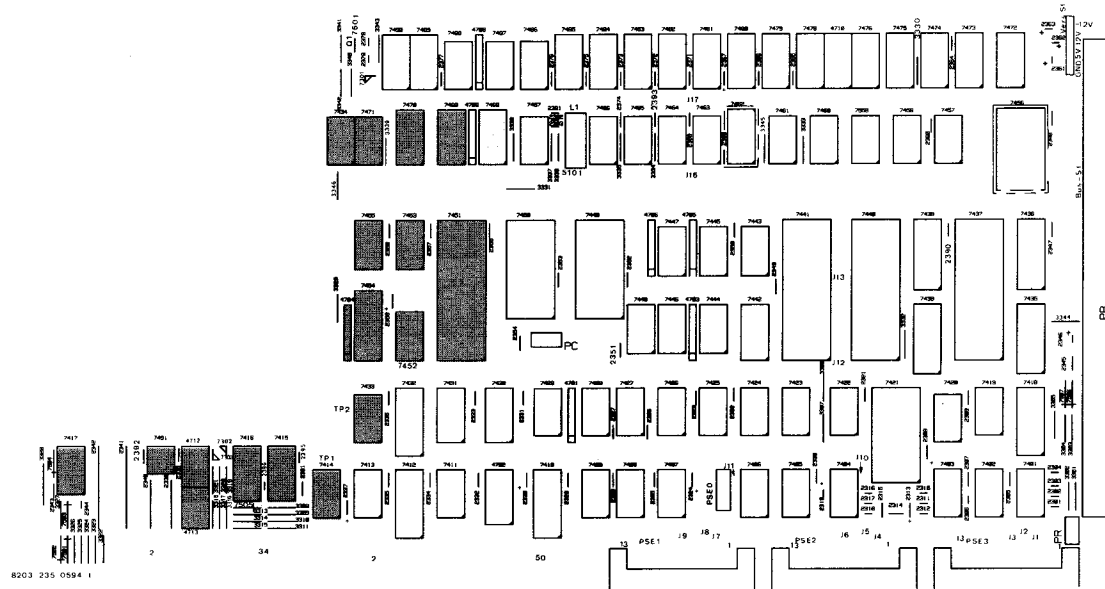

Servicing
Component Location

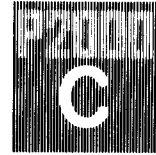

Mainboard - Baud Rate Generator CTC 3.2 / 12-1

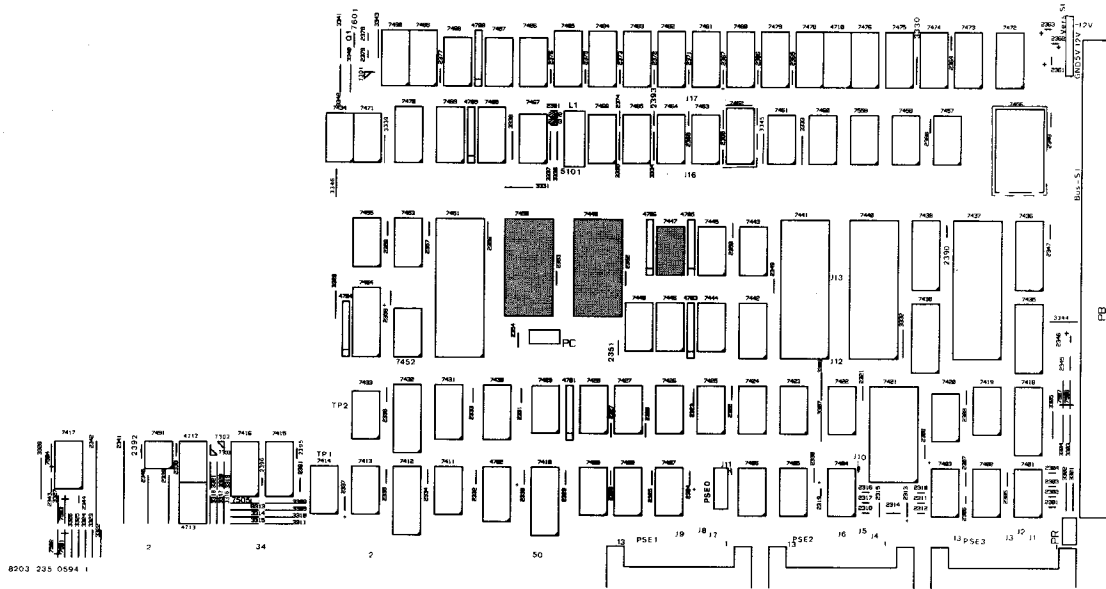

Mainboard - Serial Interfaces 3.2 / 13-1

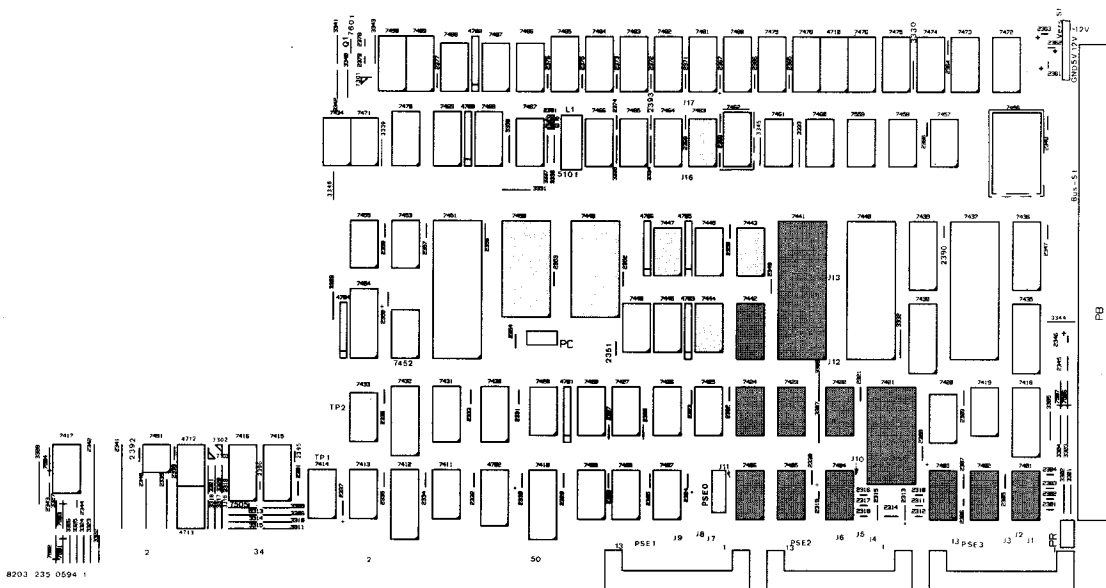

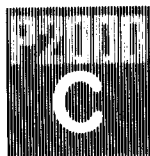

Servicing
Component Location

Terminalboard - CPU 3.3 / 2-1

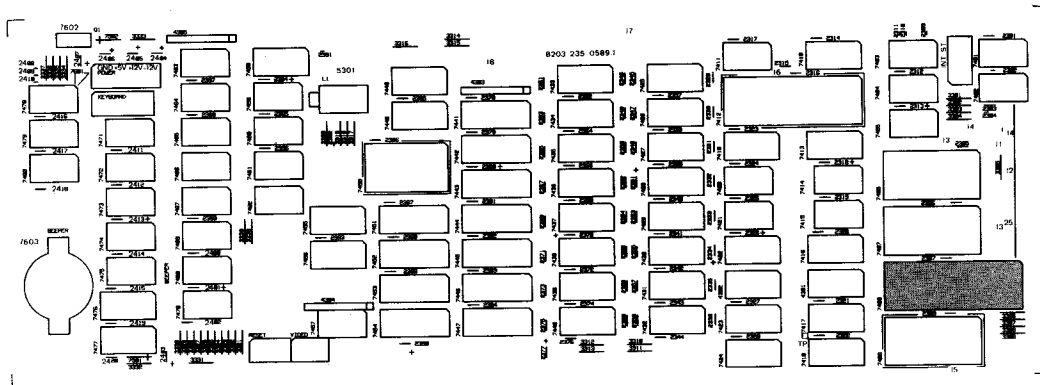

Terminalboard - CRTC 3.3 / 3-1

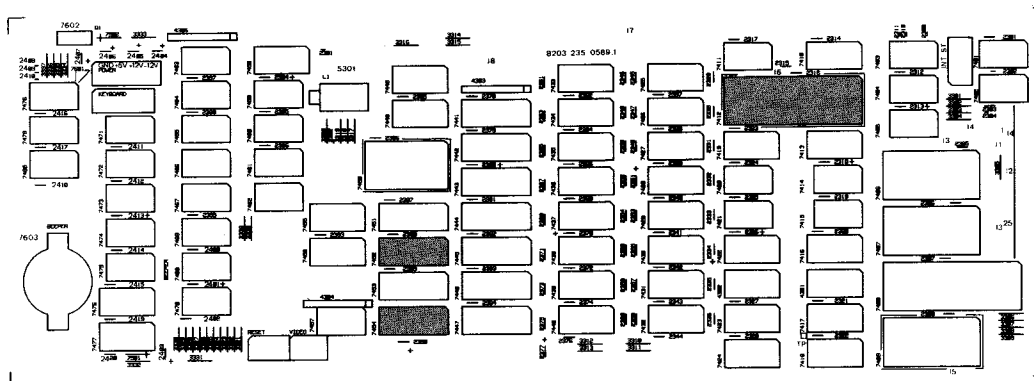

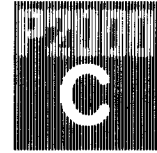

Servicing
Component Location

Terminalboard - Timing 3.3 / 4-1

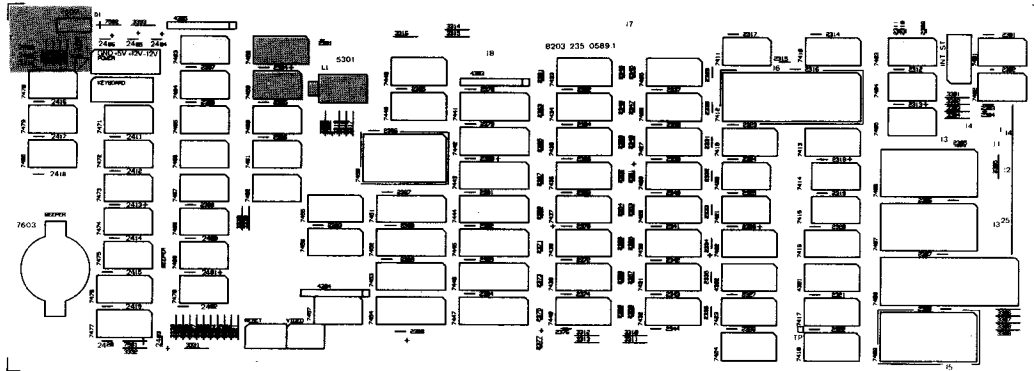

Terminalboard - RAM Banks 3.3 / 5-1

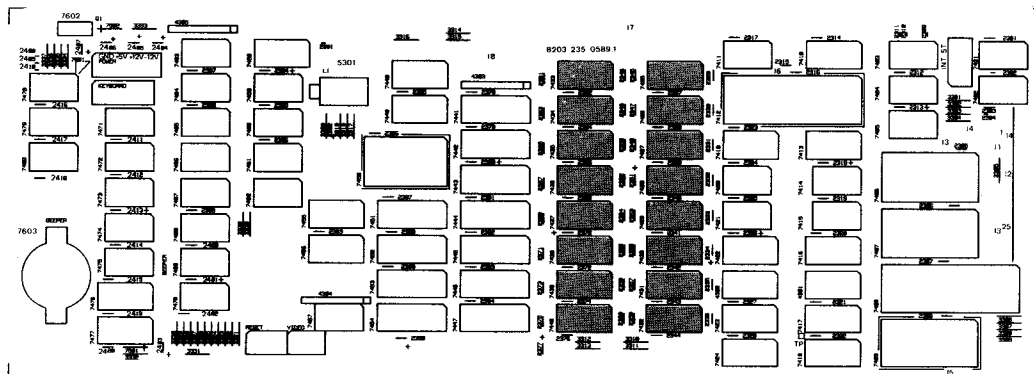

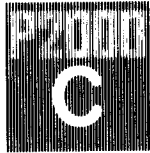

Servicing
Component Location

Terminalboard - Address Multiplexer 3.3 / 6-1

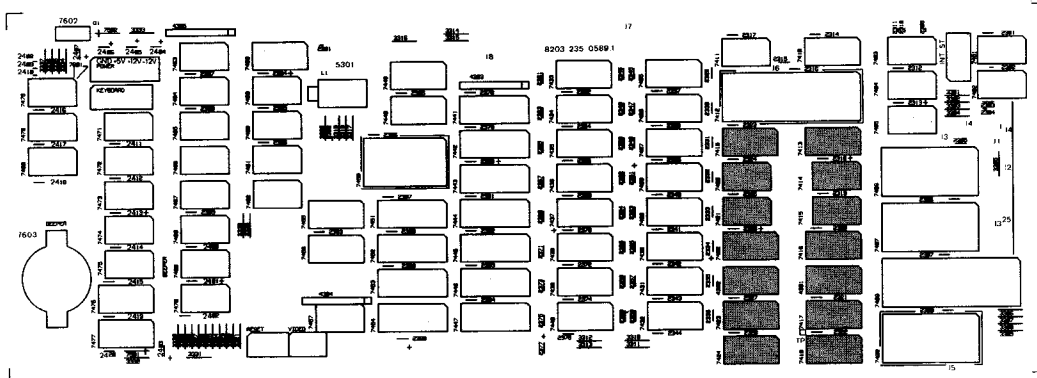

Terminalboard - Data Buffer 3.3 / 7-1

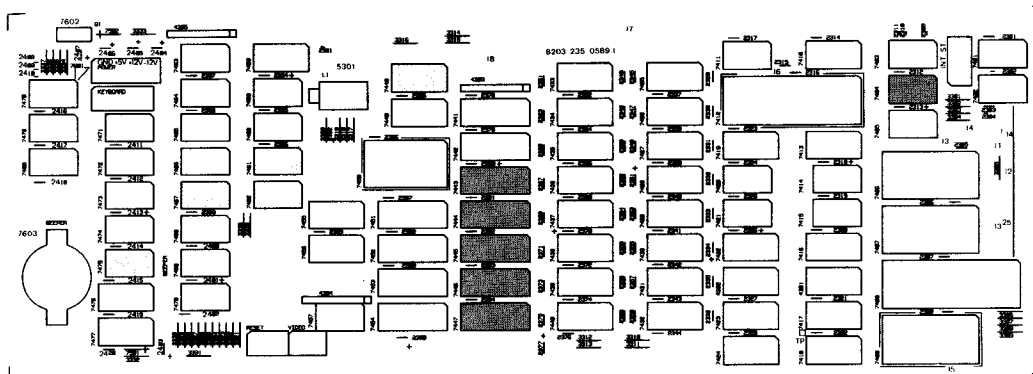

Servicing
Component Location

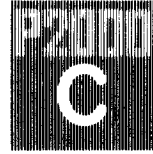

Terminalboard - Shift Register 3.3 / 8-1

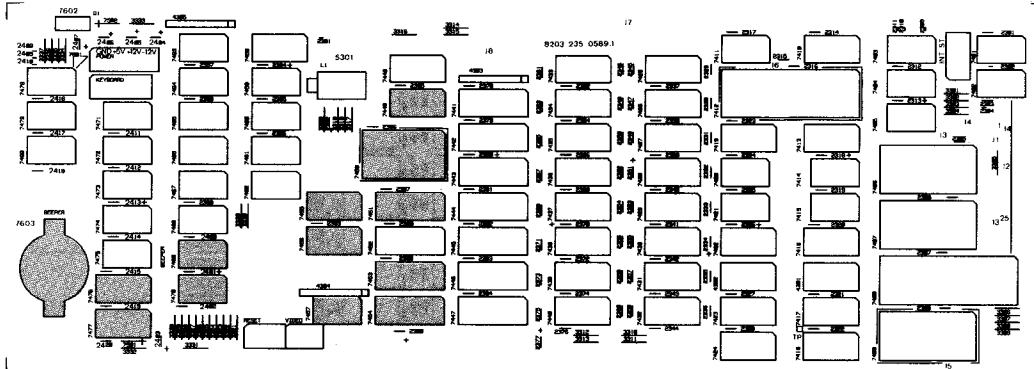

Terminalboard - Attribute Mixing 3.3 / 9-1

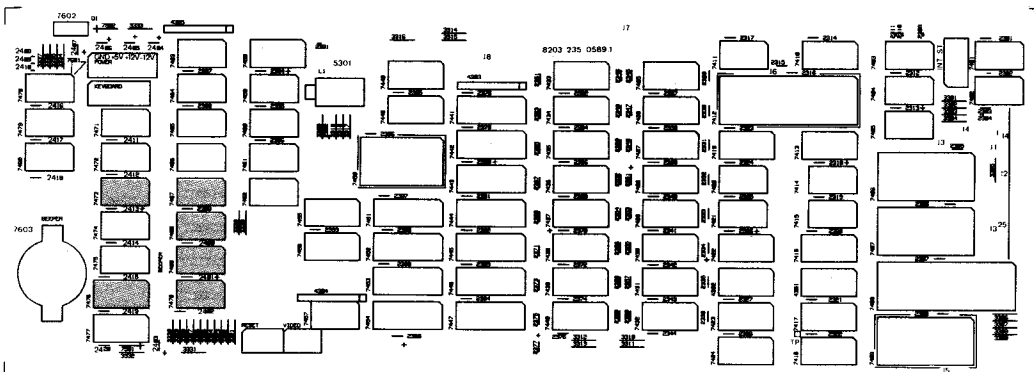



Servicing
Component Location

Terminalboard - Character Generator ROM 3.3 / 10-1

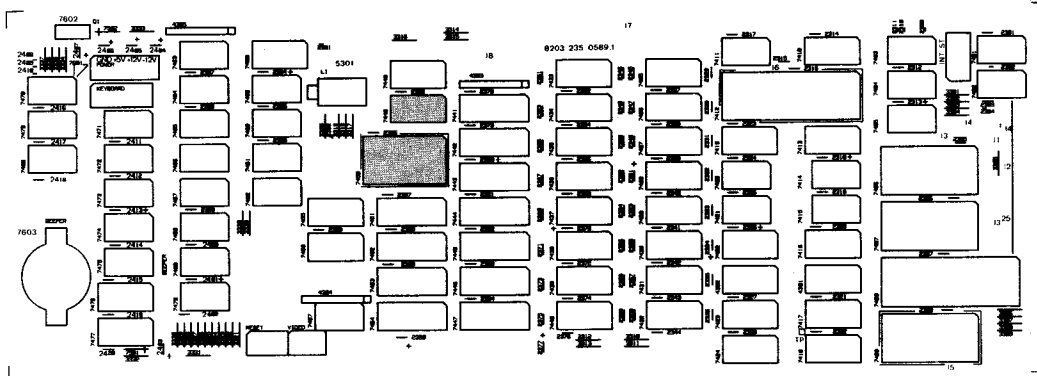

Terminalboard - CTC 3.3 / 11-1

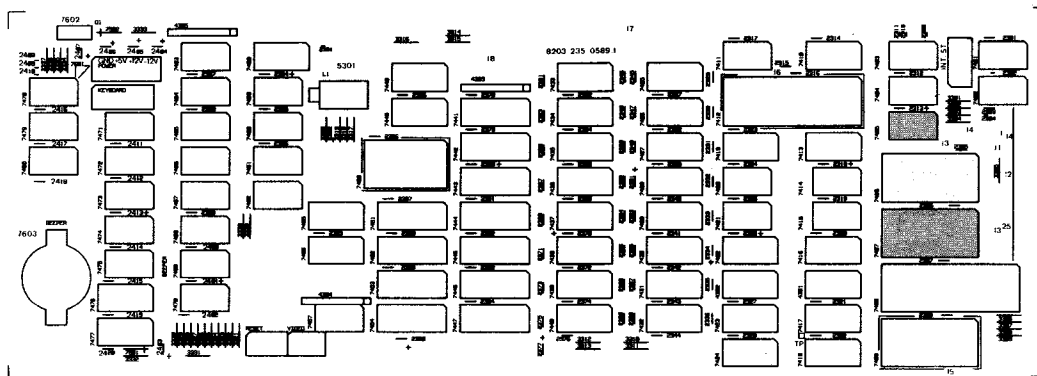

Servicing
Component Location

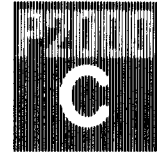

Terminalboard - V24/Internal Interface 3.3 / 12-1

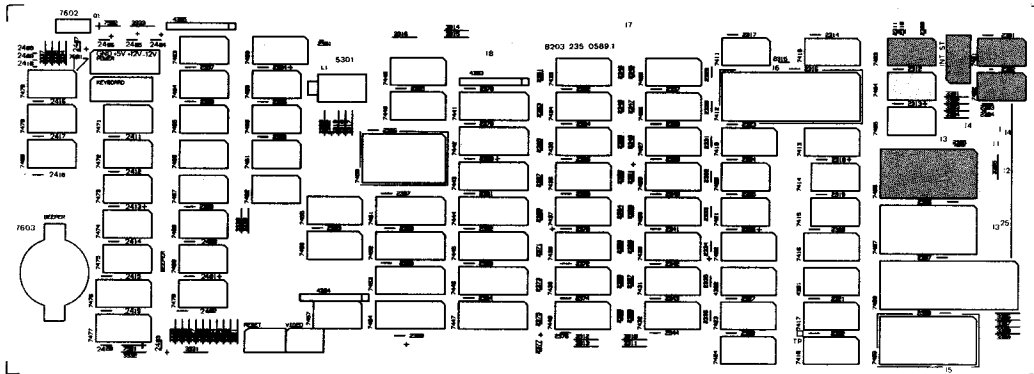

Terminalboard - Address Decoder 3.3 / 13-1

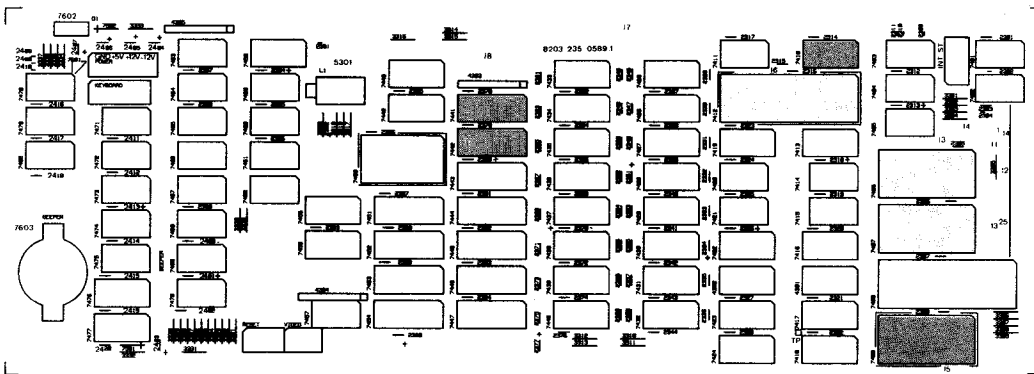



Servicing
Component Location

Terminalboard - Keyboard Logic 3.3 /14-1

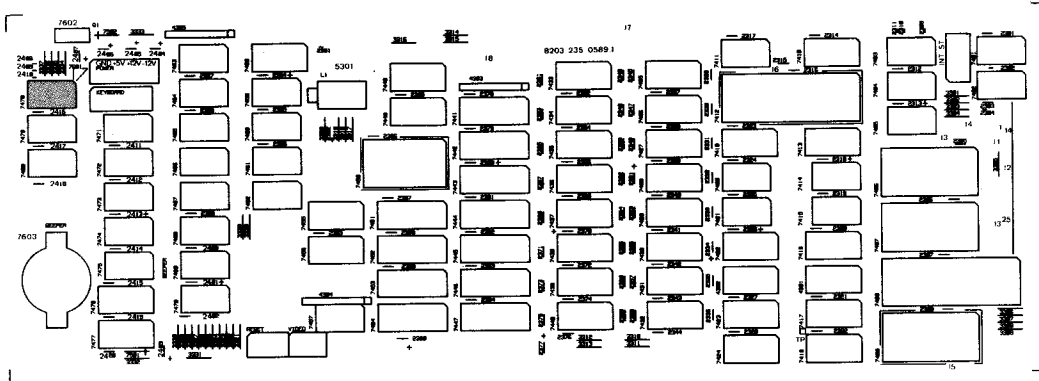

Detailed Description and Servicing
Component Location

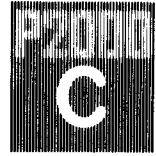

THIS PAGE INTENTIONALLY BLANK

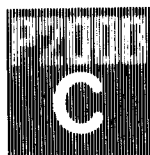

SPARE PART CATALOGUE

1984-04-14

1

GENERAL

This Spare Part Catalogue includes all electrical and the more important mechanical components and parts of the P2000C Portable Computer, covering both P 2010 and P 2012 and Options.

This catalogue is arranged in order of ITEM NUMBER under each heading, where the correct description and the SERVICE CODE of the item will be found.

ITEM part number of component on service print
QTY quantity per item number
DESCRIPTION .. definition and/or component value
CODE NUMBER .. 12NC used in manufacturing
SERVICE CODE . 12NC must be used for ordering

Special components and units, which are indicated in the part lists with an "*", are held on stock in the factory in Vienna. All other components are held on stock in the Concern Service in Eindhoven.

For ordering the following addresses must be used:

for "*" marked components and units:

Österreichische Philips Ind. G.m.b.H
EFW-Microelectronics

Service Department
Breitenseerstr. 116

A-1140 W I E N
A U S T R I A

Telex: EFPHI 131724

for standard components

Philips Export B.V.
Concern Service
Building SBP 5

Eindhoven Holland

1-2

1983-10-14

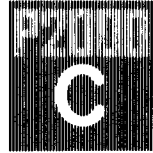
SPARE PART CATALOGUE
ORDER FORM1.1 Order Form

If you would like to be kept informed about any updates to this System Reference and Service Manual, please complete the form on the following page and return it to the address indicated.

Please fill in your name and address in CAPITALS.

As each update becomes available you will be informed of its content and of any costs that may be incurred, covering administration and postal charges.

Osterreichische Philips Ind. G.m.b.H
EFW-Microelectronics

Service Department
Breitenseerstr. 116

A-1140 W I E N
A U S T R I A

Österreichische Philips Ind. G.m.b.H
EFW-Microelectronics

Service Department
Breitenseerstr. 116
A-1140 W I E N

A U S T R I A

Yes, I want to have the updates to the:

- Spare Part Catalogue
- Reference Part please cross the required updates
- Complete Manual
- Price List

and I agree that my name is stored and that I will be informed when relevant information is available.

Surname :

Forename :

Company :

Address

Street/no:

Town/City:

Post code:

Country :

Signature:



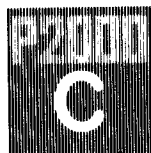

SPARE PART CATALOGUE
MAINBOARD

1984-04-14

2-1

ITEM	QTY	DESCRIPTION	CODE	NUMBER	SERVICE NUMBER
61	1	MAINBOARD PCB ASSY	5103	108 02710	* 5103 109 30000
2	1	SOCKET 8-pin 0-826375-8 (AMP)	2422	025 04093	* 5103 109 30400
3	1	SOCKET 6-pin 0-826375-6 (AMP)	2422	038 00122	* 5103 109 30400
4	1	SOCKET 4-pin 0-826375-4 (AMP)	2422	025 04092	* 5103 109 30400
5	1	CABLE ASSY 34-way 3FD1/2	5103	107 81230	* 5103 109 31420
6	1	SOCKET CONNECTOR 7-pin PRINTER	5103	108 73600	* 5103 109 30360
7	1	SOCKET CONNECTOR 11-pin COMMS.	5103	108 73620	* 5103 109 30370
31	2	IC-SOCKET 40-pin	3103	238 73270	5322 255 44217
32	1	IC-SOCKET 24-pin	3103	238 73250	5322 255 44171
33	1	IC-SOCKET 16-pin	5103	108 70200	5322 255 44107
37	1	CONNECTOR 2 x 60-pin	2422	023 98122	* 5103 109 30390
2301	1	CER-CAP CL.1 56 P G 100 V	2222	682 34569	5322 122 34205
2302	1	CER-CAP CL.1 56 P G 100 V	2222	682 34569	5322 122 34205
2303	1	CER-CAP CL.1 56 P G 100 V	2222	682 34569	5322 122 34205
2304	1	CER-CAP CL.1 56 P G 100 V	2222	682 34569	5322 122 34205
2305	1	CER-CAP 100 N S 63 V SIEM.	2012	572 10028	* 5103 109 30600
2306	1	CER-CAP CL.1 56 P G 100 V	2222	682 34569	5322 122 34205
2307	1	CER-CAP 100 N S 63 V SIEM.	2012	572 10028	* 5103 109 30600
2308	1	EL-CAP 4 M 7 63 V	2222	035 38478	4822 124 40246
2309	1	CER-CAP 100 N S 63 V SIEM.	2012	572 10028	* 5103 109 30600
2310	1	CER-CAP CL.1 56 P 100 V	2222	682 34569	5322 122 34205
2311	1	CER-CAP CL.1 56 P 100 V	2222	682 34569	5322 122 34205
2312	1	CER-CAP CL.1 56 P 100 V	2222	682 34569	5322 122 34205
2313	1	EL-CAP 4 M 7 63 V	2222	035 38478	4822 124 40246
2314	1	CER-CAP 100 N S 63 V SIEM.	2012	572 10028	* 5103 109 30600
2315	1	CER-CAP 100 N S 63 V SIEM.	2012	572 10028	* 5103 109 30600
2320	1	CER-CAP 100 N S 63 V SIEM.	2012	572 10028	* 5103 109 30600
2321	1	CER-CAP 100 N S 63 V SIEM.	2012	572 10028	* 5103 109 30600
2322	1	CER-CAP 100 N S 63 V SIEM.	2012	572 10028	* 5103 109 30600
2323	1	CER-CAP 100 N S 63 V SIEM.	2012	572 10028	* 5103 109 30600
2324	1	EL-CAP 4 M 7 63 V	2222	035 38478	4822 124 40246
2325	1	CER-CAP 100 N S 63 V SIEM.	2012	572 10028	* 5103 109 30600
2326	1	CER-CAP 100 N S 63 V SIEM.	2012	572 10028	* 5103 109 30600
2327	1	CER-CAP 100 N S 63 V SIEM.	2012	572 10028	* 5103 109 30600
2328	1	CER-CAP 100 N S 63 V SIEM.	2012	572 10028	* 5103 109 30600
2329	1	CER-CAP 100 N S 63 V SIEM.	2012	572 10028	* 5103 109 30600

1983-10-14

**SPARE PART CATALOGUE
MAINBOARD**

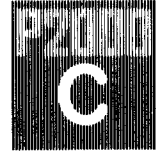

ITEM	QTY	DESCRIPTION	CODE	NUMBER	SERVICE NUMBER
2330	1	EL-CAP 4 M 7 63 V	2222	035 38478	4822 124 40246
2331	1	CER-CAP 100 N S 63 V SIEM.	2012	572 10028	* 5103 109 30600
2332	1	CER-CAP 100 N S 63 V SIEM.	2012	572 10028	* 5103 109 30600
2333	1	CER-CAP 100 N S 63 V SIEM.	2012	572 10028	* 5103 109 30600
2334	1	CER-CAP 100 N S 63 V SIEM.	2012	572 10028	* 5103 109 30600
2335	1	CER-CAP 100 N S 63 V SIEM.	2012	572 10028	* 5103 109 30600
2336	1	CER-CAP 100 N S 63 V SIEM.	2012	572 10028	* 5103 109 30600
2337	1	EL-CAP 4 M 7 63 V	2222	035 38478	4822 124 40246
2338	1	CER-CAP 100 N S 63 V SIEM.	2012	572 10028	* 5103 109 30600
2339	1	PP-CAP 1 N3 G 250 V	2222	457 71302	* 5103 109 30630
2340	1	PP-CAP 1 N3 G 250 V	2222	457 71320	* 5103 109 30630
2341	1	PP-CAP 47 N G 63 V	2222	455 74703	* 5103 109 30640
2342	1	PP-CAP 47 N G 63 V	2222	455 74703	* 5103 109 30640
2343	1	CER-CAP 100 N S 63 V SIEM.	2012	572 10028	* 5103 109 30600
2344	1	CER-CAP 100 P G 100 V	2222	682 28101	* 5103 109 30540
2345	1	CER-CAP 100 N S 63 V SIEM.	2012	572 10028	* 5103 109 30600
2346	1	EL-CAP 4 M 7 63 V	2222	035 38478	4822 124 40246
2347	1	CER-CAP 100 N S 63 V SIEM.	2012	572 10028	* 5103 109 30600
2348	1	CER-CAP 100 N S 63 V SIEM.	2012	572 10028	* 5103 109 30600
2349	1	CER-CAP 100 N S 63 V SIEM.	2012	572 10028	* 5103 109 30600
2350	1	CER-CAP 100 N S 63 V SIEM.	2012	572 10028	* 5103 109 30600
2351	1	CER-CAP 100 N S 63 V SIEM.	2012	572 10028	* 5103 109 30600
2352	1	CER-CAP 100 N S 63 V SIEM.	2012	572 10028	* 5103 109 30600
2353	1	CER-CAP 100 N S 63 V SIEM.	2012	572 10028	* 5103 109 30600
2354	1	CER-CAP 100 N S 63 V SIEM.	2012	572 10028	* 5103 109 30600
2356	1	CER-CAP 100 N S 63 V SIEM.	2012	572 10028	* 5103 109 30600
2357	1	CER-CAP 100 N S 63 V SIEM.	2012	572 10028	* 5103 109 30600
2358	1	CER-CAP 100 N S 63 V SIEM.	2012	572 10028	* 5103 109 30600
2359	1	EL-CAP 4 M 7 63 V	2222	035 38478	4822 124 40246
2360	1	CER-CAP 100 N S 63 V SIEM.	2012	572 10028	* 5103 109 30600
2361	1	EL-CAP 4 M 7 63 V	2222	035 38478	4822 124 40246
2362	1	EL-CAP 4 M 7 63 V	2222	035 38478	4822 124 40246
2363	1	EL-CAP 4 M 7 63 V	2222	035 38478	4822 124 40246
2364	1	CER-CAP 100 N S 63 V SIEM.	2012	572 10028	* 5103 109 30600
2365	1	CER-CAP 100 N S 63 V SIEM.	2012	572 10028	* 5103 109 30600
2366	1	CER-CAP 100 N S 63 V SIEM.	2012	572 10028	* 5103 109 30600
2367	1	EL-CAP 4 M 7 63 V	2222	035 38478	4822 124 40246
2368	1	CER-CAP 100 N S 63 V SIEM.	2012	572 10028	* 5103 109 30600
2369	1	CER-CAP 100 N S 63 V SIEM.	2012	572 10028	* 5103 109 30600
2371	1	CER-CAP 100 N S 63 V SIEM.	2012	572 10028	* 5103 109 30600
2372	1	CER-CAP 100 N S 63 V SIEM.	2012	572 10028	* 5103 109 30600
2373	1	CER-CAP 100 N S 63 V SIEM.	2012	572 10028	* 5103 109 30600
2374	1	CER-CAP 100 N S 63 V SIEM.	2012	572 10028	* 5103 109 30600
2375	1	CER-CAP 100 N S 63 V SIEM.	2012	572 10028	* 5103 109 30600
2376	1	CER-CAP 100 N S 63 V SIEM.	2012	572 10028	* 5103 109 30600
2377	1	CER-CAP 100 N S 63 V SIEM.	2012	572 10028	* 5103 109 30600
2378	1	CER-CAP 68 P G 100 V	2222	682 28689	* 5103 109 30530
2379	1	CER-CAP 27 P G 100 V	2222	682 04279	* 5103 109 30510

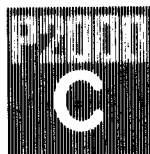

SPARE PART CATALOGUE
MAINBOARD

1983-10-14

ITEM	QTY	DESCRIPTION	CODE	NUMBER	SERVICE NUMBER
2381	1	CER-CAP 270 P G 100 V	2222	682 70271	* 5103 109 30560
2382	1	CER-CAP 270 P G 100 V	2222	682 70271	* 5103 109 30560
2383	1	CER-CAP 270 P G 100 V	2222	682 70271	* 5103 109 30560
2390	1	CER-CAP 100 N S 63 V SIEM.	2012	572 10028	* 5103 109 30600
2391	1	CER-CAP 100 N S 63 V SIEM.	2012	572 10028	* 5103 109 30600
2392	1	CER-CAP 100 N S 63 V SIEM.	2012	572 10028	* 5103 109 30600
2393	1	CER-CAP 100 N S 63 V SIEM.	2012	572 10028	* 5103 109 30600
2394	1	CER-CAP 47 P G 100 V	2222	679 28479	* 5103 109 30520
2395	1	CER-CAP 22 P G 100 V	2222	682 10229	* 5103 109 30500
2396	1	CER-CAP 100 P G 100 V	2222	682 28101	* 5103 109 30540
2397	1	CER-CAP 47 P G 100 V	2222	679 28479	* 5103 109 30520

2-4

1983-10-14

SPARE PART CATALOGUE
MAINBOARD

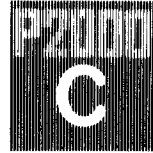

ITEM	QTY	DESCRIPTION	CODE	NUMBER	SERVICE NUMBER
4701	1	RES NETWORK 4308R-101-472 BOURNS	2122	118 00117	5322 111 94053
4702	1	RES NETWORK 4116R-003-221/331	2122	118 00238	5322 111 10318
4703	1	RES NETWORK 4308R-101-472 BOURNS	2122	118 00117	5322 111 94053
4704	1	RES NETWORK 4308R-101-472 BOURNS	2122	118 00117	5322 111 94053
4705	1	RES NETWORK 4308R-101-472 BOURNS	2122	118 00117	5322 111 94053
4706	1	RES NETWORK 4308R-101-472 BOURNS	2122	118 00117	5322 111 94053
4707	1	RES NETWORK 4308R-101-472 BOURNS	2122	118 00117	5322 111 94053
4708	1	RES NETWORK 4308R-101-472 BOURNS	2122	118 00117	5322 111 94053
4709	1	RES NETWORK 4308R-101-472 BOURNS	2122	118 00117	5322 111 94053
4710	1	RES NETWORK 898-3-R22	2122	118 00339	5322 111 94266
4712	1	POT 2 K 2 MTP 10	2322	482 20222	5322 101 14008
4713	1	TRIMPOT 4 K 7	2322	482 20472	5322 100 10114
5101	1	COIL ASSY	5103	108 20220	* 5103 109 30900
7301	1	TRANSISTOR BC 558 B	9331	977 50112	4822 130 44197
7302	1	TRANSISTOR BC 549 C	9331	977 00112	4822 130 44246
7303	1	TRANSISTOR BC 549 C	9331	977 00112	4822 130 44246



SPARE PART CATALOGUE
MAINBOARD

1983-10-14

ITEM	QTY	DESCRIPTION	CODE	NUMBER	SERVICE NUMBER
3301	1	RESISTOR (AMMOPACK) 220 R	J CR25	2322 211 73221	4822 110 73089
3302	1	RESISTOR (AMMOPACK) 220 R	J CR25	2322 211 73221	4822 110 73089
3303	1	RESISTOR (AMMOPACK) 10 K	J CR25	2322 211 73103	4822 110 73134
3304	1	RESISTOR (AMMOPACK) 10 K	J CR25	2322 211 73103	4822 110 73134
3305	1	RESISTOR (AMMOPACK) 4 K 7	J CR25	2322 211 73472	4822 110 73125
3306	1	RESISTOR (AMMOPACK) 4 K 7	J CR25	2322 211 73472	4822 110 73125
3307	1	RESISTOR (AMMOPACK) 4 K 7	J CR25	2322 211 73472	4822 110 73125
3308	1	RESISTOR (AMMOPACK) 1 K	J CR25	2322 211 73102	4822 110 73107
3309	1	RESISTOR (AMMOPACK) 12 K	J CR25	2322 211 73123	4822 110 73136
3310	1	RESISTOR (AMMOPACK) 5 K 6	J CR25	2322 211 73562	4822 110 73127
3311	1	RESISTOR (AMMOPACK) 4 K 7	J CR25	2322 211 73472	4822 110 73125
3313	1	MET-RES-LAC 2 K67	F MR25	2322 151 52672	5322 116 54578
3314	1	RESISTOR (AMMOPACK) 680 R	J CR25	2322 211 73681	4822 110 73103
3315	1	RESISTOR (AMMOPACK) 1 K	J CR25	2322 211 73102	4822 110 73107
3316	1	RESISTOR (AMMOPACK) 2 K 2	J CR25	2322 211 73222	4822 110 73116
3317	1	RESISTOR (AMMOPACK) 2 K 2	J CR25	2322 211 73222	4822 110 73116
3318	1	RESISTOR (AMMOPACK) 2 K 2	J CR25	2322 211 73222	4822 110 73116
3319	1	MET-RES-LAC 2 K67	F MR25	2322 151 52672	5322 116 54578
3320	1	MET-RES-LAC 3 K48	F MR25	2322 151 53482	5322 116 55367
3321	1	MET-RES-LAC 3 K48	F MR25	2322 151 53482	5322 116 55367
3322	1	MET-RES-LAC 1 K10	F MR25	2322 151 51102	4822 116 51236
3323	1	RESISTOR 10 K	F MR25	2322 151 51003	4822 110 73134
3324	1	MET-RES-LAC 1 K10	F MR25	2322 151 51102	4822 116 51236
3325	1	RESISTOR 10 K	F MR25	2322 151 51003	4822 110 73134
3326	1	MET-RES-LAC 1 K21	F MR25	2322 151 51212	5322 116 54557
3327	1	MET-RES-LAC 1 K	F MR25	2322 151 51002	4822 116 51235
3328	1	CARB-RES 160 R	J MR25	2322 212 13161	4822 110 51931
3329	1	RESISTOR (AMMOPACK) 470 R	J CR25	2322 211 73471	4822 110 73098
3330	1	RESISTOR (AMMOPACK) 4 K 7	J CR25	2322 211 73472	4822 110 73125
3331	1	RESISTOR (AMMOPACK) 120 R	J CR25	2322 211 73121	4822 110 73083
3332	1	RESISTOR (AMMOPACK) 4 K 7	J CR25	2322 211 73472	4822 110 73125
3333	1	RESISTOR (AMMOPACK) 10 K	J CR25	2322 211 73103	4822 110 73134
3334	1	RESISTOR (AMMOPACK) 22 R	J CR25	2322 211 73229	4822 110 73063
3335	1	RESISTOR (AMMOPACK) 22 R	J CR25	2322 211 73229	4822 110 73063
3336	1	RESISTOR (AMMOPACK) 330 R	J CR25	2322 211 73331	4822 110 73094
3337	1	RESISTOR (AMMOPACK) 220 R	J CR25	2322 211 73221	4822 110 73089
3338	1	RESISTOR (AMMOPACK) 120 R	J CR25	2322 211 73121	4822 110 73083
3339	1	RESISTOR (AMMOPACK) 270 R	J CR25	2322 211 73271	4822 110 73092
3340	1	RESISTOR (AMMOPACK) 390 R	J CR25	2322 211 73391	4822 110 73096
3341	1	RESISTOR (AMMOPACK) 27 K	J CR25	2322 211 73273	4822 110 73145
3342	1	RESISTOR (AMMOPACK) 18 K	J CR25	2322 211 73183	4822 110 73141
3343	1	RESISTOR (AMMOPACK) 180 R	J CR25	2322 211 73181	4822 110 73087
3344	1	RESISTOR (AMMOPACK) 10 K	J CR25	2322 211 73103	4822 110 73134
3345	1	RESISTOR (AMMOPACK) 4 K 7	J CR25	2322 211 73472	4822 110 73125
3346	1	RESISTOR (AMMOPACK) 1 K	J CR25	2322 211 73102	4822 110 73107

1983-10-14

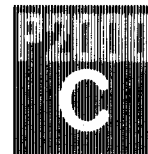
SPARE PART CATALOGUE
MAINBOARD

ITEM	QTY	DESCRIPTION		CODE	NUMBER	SERVICE NUMBER
7401	1	I.C. MC 1489		9332	912 00112	5322 209 84308
7402	1	I.C. MC 1488		9332	963 20112	5322 209 84307
7403	1	I.C. MC 1489		9332	912 00112	5322 209 84308
7405	1	I.C. MC 1488		9332	963 20112	5322 209 84307
7407	1	I.C. 74 LS 08 A		9332	869 50112	5322 209 84995
7408	1	I.C. 74 LS 32 A		9332	870 90112	5322 209 85311
7409	1	I.C. 74 LS 38 A		9332	871 10112	5322 209 85605
7410	1	I.C. 74 LS 240 N	(TI)	9334	182 20682	5322 209 85862
7411	1	I.C. 74 S 38 N		9332	920 50112	5322 209 85677
7412	1	I.C. 74 LS 240 N	(TI)	9334	182 20682	5322 209 85862
7413	1	I.C. 74 S 38 N		9332	920 50112	5322 209 85677
7414	1	I.C. 74 LS 00 A		9332	869 00112	5322 209 84823
7415	1	I.C. 74 LS 221 B		9332	875 70112	* 5103 109 31020
7416	1	I.C. 74 S 112 N		9332	877 80112	5322 209 85741
7417	1	I.C. MC 4024 P		9332	201 50682	5322 209 85819
7418	1	I.C. 74 LS 244		9334	307 60112	5322 209 86017
7419	1	I.C. 74 LS 125		9333	700 70112	5322 209 85966
7420	1	I.C. 74 LS 125		9333	700 70112	5322 209 85966
7421	1	I.C. P 8251 A	(INTEL)	9334	665 60682	5322 209 85847
7422	1	I.C. 74 LS 74 AN		9334	617 20112	4822 209 80782
7423	1	I.C. 74 LS 08 A		9332	869 50112	5322 209 84995
7424	1	I.C. 74 LS 08 A		9332	869 50112	5322 209 84995
7425	1	I.C. 74 LS 08 A		9332	869 50112	5322 209 84995
7426	1	I.C. 74 LS 32 A		9332	870 90112	5322 209 85311
7427	1	I.C. 74 LS 32 A		9332	870 90112	5322 209 85311
7428	1	I.C. 74 LS 08 A		9332	869 50112	5322 209 84995
7429	1	I.C. 74 LS 74 AN		9334	617 20112	4822 209 80782
7430	1	I.C. 74 LS 156 N		9334	121 50112	4822 209 80446
7431	1	I.C. 74 LS 367 N		9335	043 40112	5322 209 85558
7432	1	I.C. 74 LS 373 N		9334	555 00112	5322 209 86062
7433	1	I.C. 74 LS 293 A		9332	876 60112	5322 209 86016
7434	1	I.C. 74 LS 14 N		9332	870 10112	5322 209 85199
7435	1	I.C. 74 LS 244		9334	307 60112	5322 209 86017
7436	1	I.C. 74 LS 244		9334	307 60112	5322 209 86017
7437	1	Z80 A CPU	(ZILOG)	9335	977 60682	5322 209 16179
7438	1	I.C. 74 LS 373 N		9334	555 00112	5322 209 86062
7439	1	I.C. 74 LS 245	(TI)	9334	628 70682	5322 209 86225
7440	1	I.C. P 8257-5		9334	671 30682	5322 209 86551
7441	1	I.C. Z80 A - SIO - 0		9334	949 30682	* 5103 109 31200
7442	1	I.C. 74 S 157 N		9332	878 90112	5322 209 85669
7443	1	I.C. 74 LS 107		9332	872 80112	5322 209 85816
7444	1	I.C. 74 LS 04 A		9332	869 30112	4822 209 80783
7445	1	I.C. 74 LS 10 A		9332	869 70112	5322 209 84996
7446	1	I.C. 74 LS 74 AN		9334	617 20112	4822 209 80782
7447	1	I.C. 74 LS 74 AN		9334	617 20112	4822 209 80782
7448	1	I.C. 74 S 08 N		9332	876 90112	5322 209 85681
7449	1	I.C. Z80 A - CTC	(ZILOG)	9335	977 50682	5322 209 14717

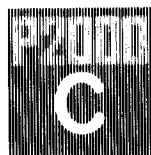
SPARE PART CATALOGUE
MAINBOARD

1983-10-14

2-7

ITEM	QTY	DESCRIPTION	CODE	NUMBER	SERVICE NUMBER
7450	1	I.C. Z80 A - CTC (ZILOG)	9335	977 50682	5322 209 14717
7451	1	I.C. PD 765	9335	284 70682	5322 209 86438
7452	1	I.C. 74 LS 04 A	9332	869 30112	4822 209 80783
7453	1	I.C. 74 LS 38 A	9332	871 10112	5322 209 85605
7554	1	I.C. 74 LS 244	9334	307 60112	5322 209 86017
7455	1	I.C. 74 LS 38 A	9332	871 10112	5322 209 85605
7456	1	ROM 4K x 8 (7456)	5103	108 73590 *	5103 109 31100
7457	1	I.C. 74 S 32 N	9332	877 20112	5322 209 85679
7458	1	I.C. 74 LS 14 N	9332	870 10112	5322 209 85199
7459	1	I.C. 74 LS 14 N	9332	870 10112	5322 209 85199
7460	1	I.C. 74 LS 00 A	9332	869 00112	5322 209 84823
7461	1	I.C. 74 LS 74 AN	9332	617 20112	4822 209 80782
7462	1	I.C. 82 S 129 N PROG.(7462)	5103	108 52350 *	5103 109 31110
7463	1	I.C. 74 LS 32 A	9332	870 90112	5322 209 85311
7464	1	I.C. 74 S 00 N	9332	813 80112	5322 209 84167
7465	1	I.C. 74 LS 00 A	9332	869 00112	5322 209 84823
7466	1	I.C. 74 S 32 N	9332	877 20112	5322 209 85679
7467	1	I.C. 74 LS 04 A	9332	869 30112	4822 209 80783
7468	1	I.C. 74 LS 175 N	9332	874 90112	5322 209 84999
7471	1	I.C. 705 MIN 7406 A	9332	830 60112	5322 209 86327
7472	1	I.C. 74 S 157 N	9332	878 90112	5322 209 85669
7473	1	I.C. 74 S 157 N	9332	878 90112	5322 209 85669
7474	1	I.C. 74 LS 139 N	9332	873 60112	5322 209 85839
7475	1	I.C. 74 LS 138 B	9332	873 50112	5322 209 85647
7476	1	I.C. 74 LS 139 N	9332	873 60112	5332 209 85839
7478	1	I.C. HM 4864-2 (HITJ)	9336	043 10682	5322 209 80977
7479	1	I.C. HM 4864-2 (HITJ)	9336	043 10682	5322 209 80977
7480	1	I.C. HM 4864-2 (HITJ)	9336	043 10682	5322 209 80977
7481	1	I.C. HM 4864-2 (HITJ)	9336	043 10682	5322 209 80977
7482	1	I.C. HM 4864-2 (HITJ)	9336	043 10682	5322 209 80977
7483	1	I.C. HM 4864-2 (HITJ)	9336	043 10682	5322 209 80977
7484	1	I.C. HM 4864-2 (HITJ)	9336	043 10682	5322 209 80977
7485	1	I.C. HM 4864-2 (HITJ)	9336	043 10682	5322 209 80977
7486	1	I.C. 74 LS 74 AN	9332	617 20112	4822 209 80782
7487	1	I.C. 74 S 38 N	9332	920 50112	5322 209 85677
7488	1	I.C. 74 LS 74 AN	9334	617 20112	4822 209 80782
7489	1	I.C. 74 LS 669 (TI)	9335	970 40682	5322 209 81026
7490	1	I.C. 74 LS 669 (TI)	9335	970 40682	5322 209 81026
7491	1	I.C. uA 741 CN	9332	404 20112	4822 209 80617
7501	1	DIODE 1N4148	9330	839 90113	4822 130 30621
7502	1	DIODE 1N4148	9330	839 90113	4822 130 30621
7503	1	DIODE BZX 79/C5V6	9331	177 30113	4822 130 34173
7504	1	DIODE 1N4148	9330	839 90113	4822 130 30621
7505	1	DIODE BZX 79/C5V6	9331	177 30113	4822 130 34173
7506	1	DIODE OA 91	9330	000 80113	4822 130 30191
7507	1	DIODE OA 91	9330	000 80113	4822 130 30191
7601	1	QUARTZ 16 MHz	8203	235 10840 *	5103 109 30950

SPARE PART CATALOGUE
MAINBOARD

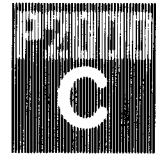

THIS PAGE INTENTIONALLY BLANK



SPARE PART CATALOGUE
TERMINALBOARD

14-10-1983

3-1

ITEM	QTY	DESCRIPTION	CODE	NUMBER	SERVICE NUMBER
64	1	TERMINALBOARD PCB ASSY	5103 108 02720	* 5103 109 30010	
2	1	SOCKET 4-pin 0-826375-4 (AMP)	2422 025 04092	* 5103 109 30400	
3	1	SOCKET 6-pin 0-826375-6 (AMP)	2422 038 00122	* 5103 109 30400	
4	1	SOCKET 7-pin 0-826375-7 (AMP)	2422 038 00123	* 5103 109 30400	
5	1	SOCKET 8-pin 0-826375-8 (AMP)	2422 025 04093	* 5103 109 30400	
9	1	SOCKET 5-pin	3103 308 70060	4822 267 50218	
10	1	IC-SOCKET 40-pin	3103 238 73270	5322 255 44217	
11	1	IC-SOCKET 28-pin	3103 238 73260	5322 255 44047	
12	1	IC-SOCKET 24-pin	3103 238 73250	5322 255 44171	
20	1	SOCKET 4-pin 0-826372-4 (AMP)	2422 038 00125	* 5103 109 30400	
2305	1	CER-CAP 100 N S 63 V SIEM.	2012 572 10028	* 5103 109 30600	
2306	1	CER-CAP 100 N S 63 V SIEM.	2012 572 10028	* 5103 109 30600	
2307	1	CER-CAP 100 N S 63 V SIEM.	2012 572 10028	* 5103 109 30600	
2308	1	CER-CAP 100 N S 63 V SIEM.	2012 572 10028	* 5103 109 30600	
2312	1	CER-CAP 100 N S 63 V SIEM.	2012 572 10028	* 5103 109 30600	
2313	1	EL-CAP 4 M 7 63 V	2222 035 38478	4822 124 40246	
2314	1	CER-CAP 100 N S 63 V SIEM.	2012 572 10028	* 5103 109 30600	
2315	1	CER-CAP 100 N S 63 V SIEM.	2012 572 10028	* 5103 109 30600	
2317	1	CER-CAP 100 N S 63 V SIEM.	2012 572 10028	* 5103 109 30600	
2318	1	EL-CAP 4 M 7 63 V	2222 035 38478	4822 124 40246	
2319	1	CER-CAP 100 N S 63 V SIEM.	2012 572 10028	* 5103 109 30600	
2320	1	CER-CAP 100 N S 63 V SIEM.	2012 572 10028	* 5103 109 30600	
2321	1	CER-CAP 100 N S 63 V SIEM.	2012 572 10028	* 5103 109 30600	
2322	1	CER-CAP 100 N S 63 V SIEM.	2012 572 10028	* 5103 109 30600	
2323	1	CER-CAP 100 N S 63 V SIEM.	2012 572 10028	* 5103 109 30600	
2324	1	CER-CAP 100 N S 63 V SIEM.	2012 572 10028	* 5103 109 30600	
2325	1	CER-CAP 100 N S 63 V SIEM.	2012 572 10028	* 5103 109 30600	
2326	1	EL-CAP 4 M 7 63 V	2222 035 38478	4822 124 40246	
2327	1	CER-CAP 100 N S 63 V SIEM.	2012 572 10028	* 5103 109 30600	
2328	1	CER-CAP 100 N S 63 V SIEM.	2012 572 10028	* 5103 109 30600	
2329	1	CER-CAP 100 N S 63 V SIEM.	2012 572 10028	* 5103 109 30600	
2330	1	CER-CAP 100 N S 63 V SIEM.	2012 572 10028	* 5103 109 30600	
2331	1	CER-CAP 100 N S 63 V SIEM.	2012 572 10028	* 5103 109 30600	
2332	1	CER-CAP 100 N S 63 V SIEM.	2012 572 10028	* 5103 109 30600	
2333	1	CER-CAP 100 N S 63 V SIEM.	2012 572 10028	* 5103 109 30600	
2334	1	EL-CAP 4 M 7 63 V	2222 035 38478	4822 124 40246	
2335	1	CER-CAP 100 N S 63 V SIEM.	2012 572 10028	* 5103 109 30600	
2336	1	CER-CAP 100 N S 63 V SIEM.	2012 572 10028	* 5103 109 30600	
2337	1	CER-CAP 100 N S 63 V SIEM.	2012 572 10028	* 5103 109 30600	
2338	1	CER-CAP 100 N S 63 V SIEM.	2012 572 10028	* 5103 109 30600	
2339	1	CER-CAP 100 N S 63 V SIEM.	2012 572 10028	* 5103 109 30600	

1983-10-14

**SPARE PART CATALOGUE
TERMINALBOARD**

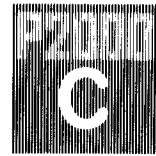

ITEM	QTY	DESCRIPTION	CODE	NUMBER	SERVICE NUMBER
2340	1	CER-CAP	100 N S 63 V SIEM.	2012 572 10028	* 5103 109 30600
2341	1	CER-CAP	100 N S 63 V SIEM.	2012 572 10028	* 5103 109 30600
2342	1	CER-CAP	100 N S 63 V SIEM.	2012 572 10028	* 5103 109 30600
2343	1	CER-CAP	100 N S 63 V SIEM.	2012 572 10028	* 5103 109 30600
2344	1	CER-CAP	100 N S 63 V SIEM.	2012 572 10028	* 5103 109 30600
2345	1	CER-CAP	100 N S 63 V SIEM.	2012 572 10028	* 5103 109 30600
2346	1	CER-CAP	100 N S 63 V SIEM.	2012 572 10028	* 5103 109 30600
2347	1	CER-CAP	100 N S 63 V SIEM.	2012 572 10028	* 5103 109 30600
2348	1	CER-CAP	100 N S 63 V SIEM.	2012 572 10028	* 5103 109 30600
2349	1	CER-CAP	100 N S 63 V SIEM.	2012 572 10028	* 5103 109 30600
2350	1	CER-CAP	100 N S 63 V SIEM.	2012 572 10028	* 5103 109 30600
2351	1	EL-CAP	4 M 7 63 V	2222 035 38478	4822 124 40246
2352	1	CER-CAP	100 N S 63 V SIEM.	2012 572 10028	* 5103 109 30600
2353	1	CER-CAP	100 N S 63 V SIEM.	2012 572 10028	* 5103 109 30600
2354	1	CER-CAP	100 N S 63 V SIEM.	2012 572 10028	* 5103 109 30600
2355	1	CER-CAP	100 N S 63 V SIEM.	2012 572 10028	* 5103 109 30600
2356	1	CER-CAP	100 N S 63 V SIEM.	2012 572 10028	* 5103 109 30600
2357	1	CER-CAP	100 N S 63 V SIEM.	2012 572 10028	* 5103 109 30600
2358	1	CER-CAP	100 N S 63 V SIEM.	2012 572 10028	* 5103 109 30600
2359	1	CER-CAP	100 N S 63 V SIEM.	2012 572 10028	* 5103 109 30600
2360	1	CER-CAP	100 N S 63 V SIEM.	2012 572 10028	* 5103 109 30600
2361	1	CER-CAP	100 N S 63 V SIEM.	2012 572 10028	* 5103 109 30600
2362	1	CER-CAP	100 N S 63 V SIEM.	2012 572 10028	* 5103 109 30600
2363	1	CER-CAP	100 N S 63 V SIEM.	2012 572 10028	* 5103 109 30600
2364	1	CER-CAP	100 N S 63 V SIEM.	2012 572 10028	* 5103 109 30600
2365	1	CER-CAP	100 N S 63 V SIEM.	2012 572 10028	* 5103 109 30600
2366	1	CER-CAP	100 N S 63 V SIEM.	2012 572 10028	* 5103 109 30600
2367	1	CER-CAP	100 N S 63 V SIEM.	2012 572 10028	* 5103 109 30600
2368	1	CER-CAP	100 N S 63 V SIEM.	2012 572 10028	* 5103 109 30600
2369	1	CER-CAP	100 N S 63 V SIEM.	2012 572 10028	* 5103 109 30600
2370	1	EL-CAP	4 M 7 63 V	2222 035 38478	4822 124 40246
2371	1	CER-CAP	100 N S 63 V SIEM.	2012 572 10028	* 5103 109 30600
2372	1	CER-CAP	100 N S 63 V SIEM.	2012 572 10028	* 5103 109 30600
2373	1	CER-CAP	100 N S 63 V SIEM.	2012 572 10028	* 5103 109 30600
2374	1	CER-CAP	100 N S 63 V SIEM.	2012 572 10028	* 5103 109 30600
2375	1	CER-CAP	100 N S 63 V SIEM.	2012 572 10028	* 5103 109 30600
2376	1	CER-CAP	100 N S 63 V SIEM.	2012 572 10028	* 5103 109 30600
2377	1	EL-CAP	4 M 7 63 V	2222 035 38478	4822 124 40246
2378	1	CER-CAP	100 N S 63 V SIEM.	2012 572 10028	* 5103 109 30600
2379	1	CER-CAP	100 N S 63 V SIEM.	2012 572 10028	* 5103 109 30600
2380	1	EL-CAP	4 M 7 63 V	2222 035 38478	4822 124 40246
2381	1	CER-CAP	100 N S 63 V SIEM.	2012 572 10028	* 5103 109 30600
2382	1	CER-CAP	100 N S 63 V SIEM.	2012 572 10028	* 5103 109 30600
2383	1	CER-CAP	100 N S 63 V SIEM.	2012 572 10028	* 5103 109 30600
2384	1	CER-CAP	100 N S 63 V SIEM.	2012 572 10028	* 5103 109 30600
2385	1	CER-CAP	100 N S 63 V SIEM.	2012 572 10028	* 5103 109 30600
2386	1	CER-CAP	100 N S 63 V SIEM.	2012 572 10028	* 5103 109 30600
2387	1	CER-CAP	100 N S 63 V SIEM.	2012 572 10028	* 5103 109 30600
2388	1	CER-CAP	100 N S 63 V SIEM.	2012 572 10028	* 5103 109 30600
2389	1	CER-CAP	100 N S 63 V SIEM.	2012 572 10028	* 5103 109 30600

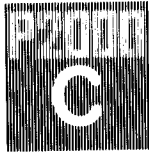

SPARE PART CATALOGUE
TERMINALBOARD

1983-10-14

ITEM	QTY	DESCRIPTION	CODE	NUMBER	SERVICE NUMBER
2390	1	EL-CAP 4 M 7 63 V	2222	035 38478	4822 124 40246
2391	1	CER-CAP 120 P G 100 V	2222	682 70121	* 5103 109 30550
2392	1	CER-CAP 390 P G 100 V	2222	682 70391	* 5103 109 30570
2393	1	CER-CAP 100 N 63 V	2012	572 10011	5322 122 34238
2394	1	EL-CAP 4 M 7 63 V	2222	035 38478	4822 124 40246
2395	1	CER-CAP 100 N S 63 V SIEM.	2012	572 10028	* 5103 109 30600
2396	1	CER-CAP 100 N S 63 V SIEM.	2012	572 10028	* 5103 109 30600
2397	1	CER-CAP 100 N S 63 V SIEM.	2012	572 10028	* 5103 109 30600
2398	1	CER-CAP 100 N S 63 V SIEM.	2012	572 10028	* 5103 109 30600
2399	1	CER-CAP 100 N S 63 V SIEM.	2012	572 10028	* 5103 109 30600
2400	1	CER-CAP 100 N S 63 V SIEM.	2012	572 10028	* 5103 109 30600
2401	1	EL-CAP 4 M 7 63 V	2222	035 38478	4822 124 40246
2402	1	CER-CAP 100 N S 63 V SIEM.	2012	572 10028	* 5103 109 30600
2403	1	EL-CAP 33 M 16 V	2222	035 35339	4822 124 40272
2404	1	EL-CAP 4 M 7 63 V	2222	035 38478	4822 124 40246
2405	1	EL-CAP 4 M 7 63 V	2222	035 38478	4822 124 40246
2406	1	EL-CAP 4 M 7 63 V	2222	035 38478	4822 124 40246
2407	1	EL-CAP 33 M 16 V	2222	035 35339	4822 124 40272
2408	1	CER-CAP 68 P G 100 V	2222	682 28689	* 5103 109 30530
2409	1	CER-CAP 27 P G 100 V	2222	682 04279	* 5103 109 30510
2410	1	CER-CAP 68 P G 100 V	2222	682 28689	* 5103 109 30530
2411	1	CER-CAP 100 N S 63 V SIEM.	2012	572 10028	* 5103 109 30600
2412	1	CER-CAP 100 N S 63 V SIEM.	2012	572 10028	* 5103 109 30600
2413	1	EL-CAP 4 M 7 63 V	2222	035 38478	4822 124 40246
2414	1	CER-CAP 100 N S 63 V SIEM.	2012	572 10028	* 5103 109 30600
2415	1	CER-CAP 100 N S 63 V SIEM.	2012	572 10028	* 5103 109 30600
2416	1	CER-CAP 100 N S 63 V SIEM.	2012	572 10028	* 5103 109 30600
2417	1	CER-CAP 100 N S 63 V SIEM.	2012	572 10028	* 5103 109 30600
2418	1	CER-CAP 100 N S 63 V SIEM.	2012	572 10028	* 5103 109 30600
2419	1	CER-CAP 100 N S 63 V SIEM.	2012	572 10028	* 5103 109 30600
2420	1	CER-CAP 100 N S 63 V SIEM.	2012	572 10028	* 5103 109 30600

3-4

1983-10-14

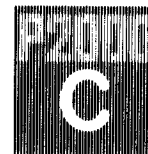
SPARE PART CATALOGUE
TERMINALBOARD

ITEM	QTY	DESCRIPTION	CODE	NUMBER	SERVICE NUMBER
3301	1	RESISTOR (AMMOPACK) 4 K 7 J CR25	2322	211 73472	4822 110 73118
3302	1	RESISTOR (AMMOPACK) 4 K 7 J CR25	2322	211 73472	4822 110 73118
3303	1	RESISTOR (AMMOPACK) 4 K 7 J CR25	2322	211 73472	4822 110 73118
3304	1	RESISTOR (AMMOPACK) 4 K 7 J CR25	2322	211 73472	4822 110 73118
3305	1	RESISTOR (AMMOPACK) 100 R J CR25	2322	211 73101	4822 110 73081
3306	1	RESISTOR (AMMOPACK) 4 K 7 J CR25	2322	211 73472	4822 110 73118
3307	1	RESISTOR (AMMOPACK) 4 K 7 J CR25	2322	211 73472	4822 110 73118
3308	1	RESISTOR (AMMOPACK) 4 K 7 J CR25	2322	211 73472	4822 110 73118
3309	1	RESISTOR (AMMOPACK) 4 K 7 J CR25	2322	211 73472	4822 110 73118
3310	1	RESISTOR (AMMOPACK) 10 R J CR25	2322	211 73109	4822 110 73054
3311	1	RESISTOR (AMMOPACK) 10 R J CR25	2322	211 73109	4822 110 73054
3312	1	RESISTOR (AMMOPACK) 10 R J CR25	2322	211 73109	4822 110 73054
3313	1	RESISTOR (AMMOPACK) 10 R J CR25	2322	211 73109	4822 110 73054
3314	1	RESISTOR (AMMOPACK) 100 R J CR25	2322	211 73101	4822 110 73081
3315	1	RESISTOR (AMMOPACK) 100 R J CR25	2322	211 73101	4822 110 73081
3316	1	RESISTOR (AMMOPACK) 4 K 7 J CR25	2322	211 73472	4822 110 73118
3317	1	RESISTOR (AMMOPACK) 100 R J CR25	2322	211 73101	4822 110 73081
3318	1	RESISTOR (AMMOPACK) 390 R J CR25	2322	211 73391	4822 110 73096
3319	1	RESISTOR (AMMOPACK) 100 R J CR25	2322	211 73101	4822 110 73081
3320	1	RESISTOR (AMMOPACK) 470 R J CR25	2322	211 73471	4822 110 73098
3321	1	RESISTOR (AMMOPACK) 330 R J CR25	2322	211 73331	4822 110 73094
3322	1	RESISTOR (AMMOPACK) 330 R J CR25	2322	211 73331	4822 110 73094
3323	1	RESISTOR (AMMOPACK) 270 R J CR25	2322	211 73271	4822 110 73092
3324	1	RESISTOR (AMMOPACK) 220 R J CR25	2322	211 73221	4822 110 73089
3325	1	RESISTOR (AMMOPACK) 100 R J CR25	2322	211 73101	4822 110 73081
3326	1	RESISTOR (AMMOPACK) 150 R J CR25	2322	211 73151	4822 110 73085
3327	1	RESISTOR (AMMOPACK) 100 R J CR25	2322	211 73101	4822 110 73081
3328	1	RESISTOR (AMMOPACK) 180 R J CR25	2322	211 73181	4822 110 73087
3329	1	RESISTOR (AMMOPACK) 330 R J CR25	2322	211 73331	4822 110 73094
3330	1	RESISTOR (AMMOPACK) 330 R J CR25	2322	211 73331	4822 110 73094
3331	1	RESISTOR (AMMOPACK) 330 R J CR25	2322	211 73331	4822 110 73094
3332	1	RESISTOR (AMMOPACK) 10 K J CR25	2322	211 73103	4822 110 73134
3333	1	RESISTOR (AMMOPACK) 1 K 2 J CR25	2322	211 73122	4822 110 73109
3334	1	RESISTOR (AMMOPACK) 18 K J CR25	2322	211 73183	4822 110 73141
3335	1	RESISTOR (AMMOPACK) 390 R J CR25	2322	211 73391	4822 110 73096
3336	1	RESISTOR (AMMOPACK) 27 K J CR25	2322	211 73273	4822 110 73145
3337	1	RESISTOR (AMMOPACK) 180 R J CR25	2322	211 73181	4822 110 73087
3338	1	RESISTOR (AMMOPACK) 100 R J CR25	2322	211 73101	4822 110 73081
3339	1	RESISTOR (AMMOPACK) 100 R J CR25	2322	211 73101	4822 110 73081
3340	1	RESISTOR (AMMOPACK) 100 K J CR25	2322	211 73104	4822 110 73161
4301	1	RES NETWORK 898-3-R22	2122	118 00339	5322 111 94266
4302	1	RES NETWORK 898-3-R22	2122	118 00339	5322 111 94266
4303	1	RES NETWORK 4310R-101-472 BOURNS	3103	200 57740	* 5103 109 30830
4304	1	RES NETWORK 4310R-101-472 BOURNS	3103	200 57740	* 5103 109 30830
4305	1	RES NETWORK 4310R-101-472 BOURNS	3103	200 57740	* 5103 109 30830
5301	1	COIL ASSY	5103	108 20270	* 5103 109 30910
5302	1	CHOKE 552-5373-14-02-00 1MU2	8203	235 19650	* 5103 109 30920

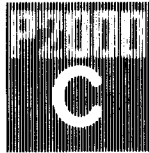

SPARE PART CATALOGUE
TERMINALBOARD

1983-10-14

ITEM	QTY	DESCRIPTION	CODE	NUMBER	SERVICE NUMBER
7404	1	I.C. 74 LS 74 AN	9334	617 20112	4822 209 80782
7405	1	I.C. 74 LS 290 A	9332	876 50112	5322 209 86015
7406	1	I.C. P 8251 A (INTEL)	9334	665 60682	5322 209 85847
7407	1	I.C. Z80A CTC (ZILOG)	9335	977 50682	5322 209 14717
7408	1	I.C. Z80A CPU (ZILOG)	9335	977 60682	5322 209 10179
7409	1	ROM 8K x 8 - 2664 (7409)	5103	108 73570	* 5103 109 31120
7410	1	I.C. 74 S 139 N	9332	878 50112	5322 209 85673
7411	1	I.C. 74 LS 32 A	9332	870 90112	5322 209 85311
7412	1	I.C. MC 68450 (MTLA)	9335	354 40682	5322 209 10176
7413	1	I.C. 74 LS 257 AN	9334	670 10112	5322 209 86334
7414	1	I.C. 74 LS 197 N	9332	919 50112	5322 209 85612
7415	1	I.C. 74 LS 197 N	9332	919 50112	5322 209 85612
7416	1	I.C. 74 LS 257 AN	9334	670 10112	5322 209 86334
7417	1	I.C. 74 LS 257 AN	9334	670 10112	5322 209 86334
7418	1	I.C. 74 LS 257 AN	9334	670 10112	5322 209 86334
7419	1	I.C. 74 LS 257 AN	9334	670 10112	5322 209 86334
7420	1	I.C. 74 LS 197 N	9332	919 50112	5322 209 85612
7421	1	I.C. 74 LS 197 N	9332	919 50112	5322 209 85612
7422	1	I.C. 74 LS 257 AN	9334	670 10112	5322 209 86334
7423	1	I.C. 74 LS 257 AN	9334	670 10112	5322 209 86334
7424	1	I.C. 74 LS 257 AN	9334	670 10112	5322 209 86334
7425	1	I.C. 416 C-5 NEC	9336	549 80682	5322 209 50108
7426	1	I.C. 416 C-5 NEC	9336	549 80682	5322 209 50108
7427	1	I.C. 416 C-5 NEC	9336	549 80682	5322 209 50108
7428	1	I.C. 416 C-5 NEC	9336	549 80682	5322 209 50108
7429	1	I.C. 416 C-5 NEC	9336	549 80682	5322 209 50108
7430	1	I.C. 416 C-5 NEC	9336	549 80682	5322 209 50108
7431	1	I.C. 416 C-5 NEC	9336	549 80682	5322 209 50108
7432	1	I.C. 416 C-5 NEC	9336	549 80682	5322 209 50108
7433	1	I.C. 416 C-5 NEC	9336	549 80682	5322 209 50108
7434	1	I.C. 416 C-5 NEC	9336	549 80682	5322 209 50108
7435	1	I.C. 416 C-5 NEC	9336	549 80682	5322 209 50108
7436	1	I.C. 416 C-5 NEC	9336	549 80682	5322 209 50108
7437	1	I.C. 416 C-5 NEC	9336	549 80682	5322 209 50108
7438	1	I.C. 416 C-5 NEC	9336	549 80682	5322 209 50108
7439	1	I.C. 416 C-5 NEC	9336	549 80682	5322 209 50108
7440	1	I.C. 416 C-5 NEC	9336	549 80682	5322 209 50108
7441	1	I.C. 74 LS 244	9334	307 60112	5322 209 86017
7442	1	I.C. 74 LS 273	9334	121 80112	5322 209 85792
7443	1	I.C. 74 S 373 N	9335	909 00112	* 5103 109 31010
7444	1	I.C. 74 LS 244	9334	307 60112	5322 209 86017
7445	1	I.C. 74 LS 245 (TI)	9334	628 70682	5322 209 86225
7446	1	I.C. 74 LS 244	9334	307 60112	5322 209 86017
7447	1	I.C. 74 LS 373 N	9334	555 00112	5322 209 86062
7448	1	I.C. 74 LS 153 N	9332	873 90112	5322 209 85488
7449	1	I.C. 74 LS 166	3103	200 57320	5322 209 86292

1983-10-14

SPARE PART CATALOGUE
TERMINALBOARD

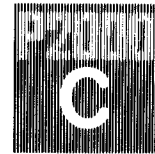

ITEM	QTY	DESCRIPTION	CODE	NUMBER	SERVICE NUMBER
7450	1	ROM 4K x 8 - 2632 (7450)	5103	108 73580	* 5103 109 31130
7451	1	I.C. 74 LS 273	9334	121 80112	5322 209 85792
7452	1	I.C. 74 LS 273	9334	121 80112	5322 209 85792
7453	1	I.C. 74 LS 273	9334	121 80112	5322 209 85792
7454	1	I.C. 74 LS 273	9334	121 80112	5322 209 85792
7455	1	I.C. 74 LS 195 AN	9333	176 80112	5322 209 85939
7456	1	I.C. 74 LS 195 AN	9333	176 80112	5322 209 85939
7457	1	I.C. 74 LS 74 AN	9334	617 20112	4822 209 80782
7458	1	I.C. 74 S 169 N-00 (TI)	9334	995 70682	* 5103 109 31000
7459	1	I.C. 74 S 04 N	9332	617 40112	5322 209 84475
7460	1	I.C. 74 S 04 N	9332	617 40112	5322 209 84475
7461	1	I.C. 74 LS 32 A	9332	870 90112	5322 209 85311
7462	1	I.C. 74 LS 32 A	9332	870 90112	5322 209 85311
7463	1	I.C. 74 LS 74 AN	9334	617 20112	4822 209 80782
7464	1	I.C. 74 LS 74 AN	9334	617 20112	4822 209 80782
7465	1	I.C. 74 S 32 N	9332	877 20112	5322 209 85679
7466	1	I.C. 74 LS 04 A	9332	869 30112	4822 209 80783
7467	1	I.C. 74 LS 32 A	9332	870 90112	5322 209 85311
7468	1	I.C. 74 LS 293 A	9332	876 60112	5322 209 86016
7469	1	I.C. 7407 A	9332	830 80112	5322 209 84761
7470	1	I.C. 7407 A	9332	830 80112	5322 209 84761
7471	1	I.C. 74 LS 10 A	9332	869 70112	5322 209 84996
7472	1	I.C. 74 LS 02 N	9332	876 80112	5322 209 85407
7473	1	I.C. 74 S 00 N	9332	813 80112	5322 209 84167
7474	1	I.C. 74 LS 00 A	9332	869 00112	5322 209 84823
7475	1	I.C. 74 LS 86 A	9332	872 20112	5322 209 84997
7476	1	I.C. 74 LS 399 N-00 (TI)	9335	105 70682	* 5103 109 31030
7477	1	I.C. 74 LS 157 B	9332	874 00112	5322 209 85489
7478	1	I.C. 74 LS 10 A	9332	869 70112	5322 209 84996
7479	1	I.C. 74 LS 14 N	9332	870 10112	5322 209 85199
7480	1	I.C. 74 S 08 N	9332	876 90112	5322 209 85681
7501	1	DIODE OA 91	9330	000 80113	4822 130 30191
7502	1	DIODE BZX 79/C5V1	9331	177 20113	4822 130 34233
7601	1	TRANSISTOR BC 558 B	9331	977 50112	5322 130 44197
7602	1	QUARTZ 12.288 MHz	8203	235 19240	* 5103 109 30960
7603	1	CER. RESONATOR	5103	108 70670	5322 280 14028

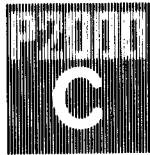

SPARE PART CATALOGUE
KEYBOARD

1983-10-14

4-1

ITEM	QTY	DESCRIPTION	CODE	NUMBER	SERVICE NUMBER
	1	KEYBOARD PCB-ASSY	5103	108 02760	* 5103 109 30030
2	1	SWITCH LP ASSY (92 OFF)	5112	291 43290	* 5103 109 30340
3	1	SWITCH LE ASSY (2 OFF)	5112	291 42910	* 5103 109 30350
13	1	SOCKET 6-pin	2422	026 00264	* 5103 109 30330
2101	1	CER-CAP 100 N S 63 V SIEM.	2012	572 10028	* 5103 109 30600
2102	1	CER-CAP 100 N S 63 V SIEM.	2012	572 10028	* 5103 109 30600
2103	1	CER-CAP CL.1 100 P G 100 V	2222	682 28101	* 5103 109 30540
2104	1	CER-CAP CL.1 100 P G 100 V	2222	682 28101	* 5103 109 30540
3101	1	RESISTOR (AMMOPACK) 2 K 2 J CR25	2322	211 73222	4822 110 73116
3102	1	RESISTOR (AMMOPACK) 2 K 2 J CR25	2322	211 73222	4822 110 73116
3103	1	RESISTOR (AMMOPACK) 270 R J CR25	2322	211 73271	4822 110 73092
3104	1	RESISTOR (AMMOPACK) 1 K J CR25	2322	211 73102	4822 110 73107
3105	1	RESISTOR (AMMOPACK) 2 K 2 J CR25	2322	211 73222	4822 110 73116
3106	1	RESISTOR (AMMOPACK) 2 K 2 J CR25	2322	211 73222	4822 110 73116
4101	1	RES NETWORK 4310R-101-222	2122	118 00326	* 5103 109 30820
7001	1	L.E.D. LD 30/1	9333	203 30112	* 5103 109 31300
7101	1	I.C. 74 LS 74 AN	9334	617 20112	4822 209 80782
7102	1	I.C. 74 LS 10 A	9332	869 70112	5322 209 84996
7103	1	I.C. 74 150 N	9332	564 30112	* 5103 109 31050
7104	1	I.C. 74 LS 290 A	9332	876 50112	5322 209 86015
7105	1	I.C. 74 LS 293 A	9332	876 60112	5322 209 86016
7106	1	I.C. 74 159 N-00 (TI)	9335	010 40682	* 5103 109 31040
7150	1	VOLTAGE REG. 7805 CU	9332	996 00112	* 5103 109 31310
1	1	KEYBOARD CASE	5103	104 18770	* 5103 109 30250
8	1	KEYBOARD MASK	5103	104 18760	* 5103 109 30260
9	4	RUBBER FOOT	5103	104 40940	* 5103 109 30240

SPARE PART CATALOGUE
KEYBOARD



THIS PAGE INTENTIONALLY BLANK

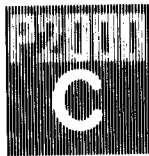

SPARE PART CATALOGUE
IEEE-BOARD

1983-10-14

5-1

ITEM	QTY	DESCRIPTION	CODE	NUMBER	SERVICE NUMBER
95	1	IEEE-BOARD (IEC-BUS) PCB ASSY	5103	108 02900	* 5103 109 30040
2	1	SOCKET 24-pin	2422	025 04295	* 5103 109 30380
2101	1	CER-CAP 100 N S 63 V SIEM.	2012	572 10028	* 5103 109 30600
2102	1	CER-CAP 100 N S 63 V SIEM.	2012	572 10028	* 5103 109 30600
2103	1	EL-CAP 4 M7 63 V	2222	035 38478	4822 124 40246
2104	1	CER-CAP 100 N S 63 V SIEM.	2012	572 10028	* 5103 109 30600
2105	1	CER-CAP 100 N S 63 V SIEM.	2012	572 10028	* 5103 109 30600
2106	1	CER-CAP 100 N S 63 V SIEM.	2012	572 10028	* 5103 109 30600
2107	1	CER-CAP 100 N S 63 V SIEM.	2012	572 10028	* 5103 109 30600
2108	1	CER-CAP 100 N S 63 V SIEM.	2012	572 10028	* 5103 109 30600
2109	1	CER-CAP 100 N S 63 V SIEM.	2012	572 10028	* 5103 109 30600
2110	1	CER-CAP 100 N S 63 V SIEM.	2012	572 10028	* 5103 109 30600
3101	1	RESISTOR (AMMOPACK) 6 K 2 J CR25	2322	211 73622	4822 110 70128
3102	1	RESISTOR (AMMOPACK) 6 K 2 J CR25	2322	211 73622	4822 110 70128
3103	1	RESISTOR (AMMOPACK) 6 K 2 J CR25	2322	211 73622	4822 110 70128
3104	1	RESISTOR (AMMOPACK) 6 K 2 J CR25	2322	211 73622	4822 110 70128
3105	1	RESISTOR (AMMOPACK) 6 K 2 J CR25	2322	211 73622	4822 110 70128
3106	1	RESISTOR (AMMOPACK) 6 K 2 J CR25	2322	211 73622	4822 110 70128
3107	1	RESISTOR (AMMOPACK) 6 K 2 J CR25	2322	211 73622	4822 110 70128
3108	1	RESISTOR (AMMOPACK) 6 K 2 J CR25	2322	211 73622	4822 110 70128
3109	1	RESISTOR (AMMOPACK) 6 K 2 J CR25	2322	211 73622	4822 110 70128
3110	1	RESISTOR (AMMOPACK) 6 K 2 J CR25	2322	211 73622	4822 110 70128
3111	1	RESISTOR (AMMOPACK) 6 K 2 J CR25	2322	211 73622	4822 110 70128
3112	1	RESISTOR (AMMOPACK) 6 K 2 J CR25	2322	211 73622	4822 110 70128
3113	1	RESISTOR (AMMOPACK) 6 K 2 J CR25	2322	211 73622	4822 110 70128
3114	1	RESISTOR (AMMOPACK) 6 K 2 J CR25	2322	211 73622	4822 110 70128
3115	1	RESISTOR (AMMOPACK) 6 K 2 J CR25	2322	211 73622	4822 110 70128
3116	1	RESISTOR (AMMOPACK) 6 K 2 J CR25	2322	211 73622	4822 110 70128
3117	1	RESISTOR (AMMOPACK) 3 K J CR25	2322	211 73302	4822 110 70119
3118	1	RESISTOR (AMMOPACK) 3 K J CR25	2322	211 73302	4822 110 70119
3119	1	RESISTOR (AMMOPACK) 3 K J CR25	2322	211 73302	4822 110 70119
3120	1	RESISTOR (AMMOPACK) 3 K J CR25	2322	211 73302	4822 110 70119
3121	1	RESISTOR (AMMOPACK) 3 K J CR25	2322	211 73302	4822 110 70119
3122	1	RESISTOR (AMMOPACK) 3 K J CR25	2322	211 73302	4822 110 70119
3123	1	RESISTOR (AMMOPACK) 3 K J CR25	2322	211 73302	4822 110 70119
3124	1	RESISTOR (AMMOPACK) 3 K J CR25	2322	211 73302	4822 110 70119
3125	1	RESISTOR (AMMOPACK) 3 K J CR25	2322	211 73302	4822 110 70119
3126	1	RESISTOR (AMMOPACK) 3 K J CR25	2322	211 73302	4822 110 70119
3127	1	RESISTOR (AMMOPACK) 3 K J CR25	2322	211 73302	4822 110 70119
3128	1	RESISTOR (AMMOPACK) 3 K J CR25	2322	211 73302	4822 110 70119
3129	1	RESISTOR (AMMOPACK) 3 K J CR25	2322	211 73302	4822 110 70119
3130	1	RESISTOR (AMMOPACK) 3 K J CR25	2322	211 73302	4822 110 70119
3131	1	RESISTOR (AMMOPACK) 3 K J CR25	2322	211 73302	4822 110 70119
3132	1	RESISTOR (AMMOPACK) 3 K J CR25	2322	211 73302	4822 110 70119
3133	1	RESISTOR (AMMOPACK) 3 K J CR25	2322	211 73302	4822 110 70119
3134	1	RESISTOR (AMMOPACK) 3 K J CR25	2322	211 73302	4822 110 70119

1983-10-14

SPARE PART CATALOGUE
IEEE-BOARD

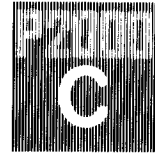

ITEM	QTY	DESCRIPTION	CODE	NUMBER	SERVICE NUMBER
7101	1	I.C. 74 S 38 N	9332	920 50112	5322 209 85677
7102	1	I.C. 74 LS 240 N (TI)	9334	182 20682	5322 209 85862
7103	1	I.C. 74 LS 273	9334	121 80112	5322 209 85792
7104	1	I.C. 74 LS 245 N (TI)	9336	628 70682	5322 209 86225
7105	1	I.C. 74 S 38 N	9332	920 50112	5322 209 85677
7106	1	I.C. 74 S 38 N	9322	920 50112	5322 209 85677
7107	1	I.C. 74 LS 30 A	9332	870 80112	5322 209 84985
7108	1	I.C. 74 S 38 N	9332	920 50112	5322 209 85677
7109	1	I.C. 74 LS 240 N	9334	201 20112	5322 209 85862
7110	1	I.C. 74 LS 273	9334	121 80112	5322 209 85792
7111	1	I.C. 74 LS 139 N	9332	873 60112	5322 209 85839
7112	1	I.C. 74 LS 08 A	9332	869 50112	5322 209 84995

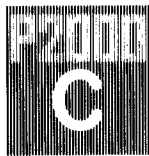

SPARE PART CATALOGUE
4x64k RAM-BOARD

1983-10-14

ITEM	QTY	DESCRIPTION	CODE	NUMBER	SERVICE NUMBER
1	1	4x64k RAM BOARD PCB ASSY	5103 108 02970	*	5103 109 30050
2001	1	CER-CAP CL.1 390 P G 100 V	2222 679 70391	*	5103 109 30570
2002	1	CER-CAP CL.1 390 P G 100 V	2222 679 70391	*	5103 109 30570
2003	1	CER-CAP 100 N S 63 V SIEM.	2012 572 10028	*	5103 109 30600
2004	1	CER-CAP 100 N S 63 V SIEM.	2012 572 10028	*	5103 109 30600
2005	1	EL-CAP 33 M 16 V	2222 035 35339		4822 124 40272
2006	1	CER-CAP 100 N S 63 V SIEM.	2012 572 10028	*	5103 109 30600
2007	1	CER-CAP 100 N S 63 V SIEM.	2012 572 10028	*	5103 109 30600
2008	1	CER-CAP 100 N S 63 V SIEM.	2012 572 10028	*	5103 109 30600
2009	1	CER-CAP 100 N S 63 V SIEM.	2012 572 10028	*	5103 109 30600
2010	1	CER-CAP 100 N S 63 V SIEM.	2012 572 10028	*	5103 109 30600
2011	1	CER-CAP 100 N S 63 V SIEM.	2012 572 10028	*	5103 109 30600
2012	1	CER-CAP 100 N S 63 V SIEM.	2012 572 10028	*	5103 109 30600
2013	1	CER-CAP 100 N S 63 V SIEM.	2012 572 10028	*	5103 109 30600
2014	1	CER-CAP 100 N S 63 V SIEM.	2012 572 10028	*	5103 109 30600
2015	1	CER-CAP 100 N S 63 V SIEM.	2012 572 10028	*	5103 109 30600
2016	1	CER-CAP 100 N S 63 V SIEM.	2012 572 10028	*	5103 109 30600
2017	1	CER-CAP 100 N S 63 V SIEM.	2012 572 10028	*	5103 109 30600
2018	1	CER-CAP 100 N S 63 V SIEM.	2012 572 10028	*	5103 109 30600
2019	1	CER-CAP 100 N S 63 V SIEM.	2012 572 10028	*	5103 109 30600
2020	1	CER-CAP 100 N S 63 V SIEM.	2012 572 10028	*	5103 109 30600
2021	1	CER-CAP 100 N S 63 V SIEM.	2012 572 10028	*	5103 109 30600
2022	1	CER-CAP 100 N S 63 V SIEM.	2012 572 10028	*	5103 109 30600
2023	1	CER-CAP 100 N S 63 V SIEM.	2012 572 10028	*	5103 109 30600
2024	1	CER-CAP 100 N S 63 V SIEM.	2012 572 10028	*	5103 109 30600
2025	1	CER-CAP 100 N S 63 V SIEM.	2012 572 10028	*	5103 109 30600
2026	1	CER-CAP 100 N S 63 V SIEM.	2012 572 10028	*	5103 109 30600
2027	1	CER-CAP 100 N S 63 V SIEM.	2012 572 10028	*	5103 109 30600
2028	1	CER-CAP 100 N S 63 V SIEM.	2012 572 10028	*	5103 109 30600
2029	1	CER-CAP 100 N S 63 V SIEM.	2012 572 10028	*	5103 109 30600
2030	1	CER-CAP 100 N S 63 V SIEM.	2012 572 10028	*	5103 109 30600
2031	1	CER-CAP 100 N S 63 V SIEM.	2012 572 10028	*	5103 109 30600
2032	1	CER-CAP 100 N S 63 V SIEM.	2012 572 10028	*	5103 109 30600
2033	1	CER-CAP 100 N S 63 V SIEM.	2012 572 10028	*	5103 109 30600
2034	1	CER-CAP 100 N S 63 V SIEM.	2012 572 10028	*	5103 109 30600
2035	1	CER-CAP 100 N S 63 V SIEM.	2012 572 10028	*	5103 109 30600
2036	1	CER-CAP 100 N S 63 V SIEM.	2012 572 10028	*	5103 109 30600
2037	1	CER-CAP 100 N S 63 V SIEM.	2012 572 10028	*	5103 109 30600
2038	1	CER-CAP 100 N S 63 V SIEM.	2012 572 10028	*	5103 109 30600
2039	1	CER-CAP 100 N S 63 V SIEM.	2012 572 10028	*	5103 109 30600
2040	1	CER-CAP 100 N S 63 V SIEM.	2012 572 10028	*	5103 109 30600
2041	1	CER-CAP 100 N S 63 V SIEM.	2012 572 10028	*	5103 109 30600
2042	1	CER-CAP 100 N S 63 V SIEM.	2012 572 10028	*	5103 109 30600
2043	1	CER-CAP 100 N S 63 V SIEM.	2012 572 10028	*	5103 109 30600
2044	1	CER-CAP 100 N S 63 V SIEM.	2012 572 10028	*	5103 109 30600
2045	1	EL-CAP 33 M 16 V	2222 035 35339		4822 124 40272

1983-10-14

SPARE PART CATALOGUE
4x64k RAM-BOARD

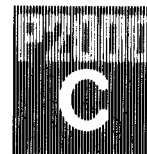

ITEM	QTY	DESCRIPTION	CODE	NUMBER	SERVICE NUMBER
3001	1	RESISTOR (AMMOPACK) 100 R	J CR25	2322 211 73101	4822 110 73081
3002	1	RESISTOR (AMMOPACK) 220 R	J CR25	2322 211 73221	4822 110 73089
3003	1	RESISTOR (AMMOPACK) 100 R	J CR25	2322 211 73101	4822 110 73081
4001	1	RES NETWORK 898-3-R22		2122 118 00339	5322 111 94266
4002	1	RES NETWORK 4310R-101-561 (BOURNS)		2122 118 00734	* 5103 109 30840
4003	1	RES NETWORK 898-3-R22		2122 118 00339	5322 111 94266
5001	1	COIL ASSY		5103 108 20270	* 5103 109 30910



SPARE PART CATALOGUE
4x64k RAM-BOARD

1984-04-14

ITEM	QTY	DESCRIPTION	CODE	NUMBER	SERVICE NUMBER
7001	1	I.C. 74 LS 11	9332	869 80112	* 5103 109 31060
7002	1	I.C. 74 S 123 N (7002) RAM	5103	108 52370	* 5103 109 31150
7003	1	I.C. 74 LS 174 B	9332	874 80112	4822 209 50008
7004	1	I.C. 74 LS 244	9334	307 60112	5322 209 86017
7005	1	I.C. 74 S 00 N	9332	813 80112	5322 209 84167
7006	1	I.C. 74 S 04 N	9332	617 40112	5322 209 84475
7007	1	I.C. 74 LS 02 A	9332	886 70112	5322 209 85312
7008	1	I.C. 74 S 00 N	9332	813 80112	5322 209 84167
7009	1	I.C. 74 LS 30 A	9332	870 80112	5322 209 84985
7010	1	I.C. 82 S 129 N (7010) RAM	5103	108 52380	* 5103 109 31160
7011	1	I.C. 82 S 126 N (7011) RAM	5103	108 52520	* 5103 109 31170
7012	1	I.C. 74 S 157 N	9332	878 90112	5322 209 85669
7013	1	I.C. 74 S 157 N	9332	878 90112	5322 209 85669
7014	1	I.C. HM 4864-2 (HITJ)	9336	043 10682	5322 209 80977
7015	1	I.C. HM 4864-2 (HITJ)	9336	043 10682	5322 209 80977
7016	1	I.C. HM 4864-2 (HITJ)	9336	043 10682	5322 209 80977
7017	1	I.C. HM 4864-2 (HITJ)	9336	043 10682	5322 209 80977
7018	1	I.C. HM 4864-2 (HITJ)	9336	043 10682	5322 209 80977
7019	1	I.C. HM 4864-2 (HITJ)	9336	043 10682	5322 209 80977
7020	1	I.C. HM 4864-2 (HITJ)	9336	043 10682	5322 209 80977
7021	1	I.C. HM 4864-2 (HITJ)	9336	043 10682	5322 209 80977
7022	1	I.C. HM 4864-2 (HITJ)	9336	043 10682	5322 209 80977
7023	1	I.C. HM 4864-2 (HITJ)	9336	043 10682	5322 209 80977
7024	1	I.C. HM 4864-2 (HITJ)	9336	043 10682	5322 209 80977
7025	1	I.C. HM 4864-2 (HITJ)	9336	043 10682	5322 209 80977
7026	1	I.C. HM 4864-2 (HITJ)	9336	043 10682	5322 209 80977
7027	1	I.C. HM 4864-2 (HITJ)	9336	043 10682	5322 209 80977
7028	1	I.C. HM 4864-2 (HITJ)	9336	043 10682	5322 209 80977
7029	1	I.C. HM 4864-2 (HITJ)	9336	043 10682	5322 209 80977
7030	1	I.C. HM 4864-2 (HITJ)	9336	043 10682	5322 209 80977
7031	1	I.C. HM 4864-2 (HITJ)	9336	043 10682	5322 209 80977
7032	1	I.C. HM 4864-2 (HITJ)	9336	043 10682	5322 209 80977
7033	1	I.C. HM 4864-2 (HITJ)	9336	043 10682	5322 209 80977
7034	1	I.C. HM 4864-2 (HITJ)	9336	043 10682	5322 209 80977
7035	1	I.C. HM 4864-2 (HITJ)	9336	043 10682	5322 209 80977
7036	1	I.C. HM 4864-2 (HITJ)	9336	043 10682	5322 209 80977
7037	1	I.C. HM 4864-2 (HITJ)	9336	043 10682	5322 209 80977
7038	1	I.C. HM 4864-2 (HITJ)	9336	043 10682	5322 209 80977
7039	1	I.C. HM 4864-2 (HITJ)	9336	043 10682	5322 209 80977
7040	1	I.C. HM 4864-2 (HITJ)	9336	043 10682	5322 209 80977
7041	1	I.C. HM 4864-2 (HITJ)	9336	043 10682	5322 209 80977
7042	1	I.C. HM 4864-2 (HITJ)	9336	043 10682	5322 209 80977
7043	1	I.C. HM 4864-2 (HITJ)	9336	043 10682	5322 209 80977
7044	1	I.C. HM 4864-2 (HITJ)	9336	043 10682	5322 209 80977
7045	1	I.C. HM 4864-2 (HITJ)	9336	043 10682	5322 209 80977

SPARE PART CATALOGUE
4x64k RAM-BOARD

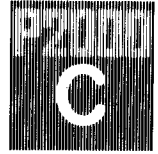

THIS PAGE INTENTIONALLY BLANK



SPARE PART CATALOGUE
MISCELLANEOUS PARTS

1983-10-14

ITEM	QTY	DESCRIPTION	CODE	NUMBER	SERVICE NUMBER
33	1	POWER SUPPLY UNIT	5103 108	73540	* 5103 109 30100
38	1	MONITOR MONOCHROME GREEN	5103 108	73530	* 5103 109 30110
42	1	FLOPPY DISK UNIT 160K	5103 108	52260	* 5103 109 30120
42	1	FLOPPY DISK UNIT 640K	5103 108	73680	* 5103 109 30130
55	1	DISTRIBUTION BOARD ASSY	5103 108	02730	* 5103 109 30020
HOUSING					
51	1	FRONT MASK	5103 107	59600	* 5103 109 30200
70	1	REAR MASK	5103 104	18660	* 5103 109 30210
72	1	CASE COVER	5103 107	59790	* 5103 109 30220
45	1	BOTTOM PLATE	5103 104	18620	* 5103 109 30230
46	1	RUBBER FOOT	5103 104	40940	* 5103 109 30240

SPARE PART CATALOGUE
MISCELLANEOUS PARTS



THIS PAGE INTENTIONALLY BLANK

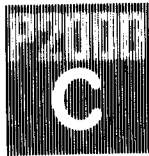

Character Generator Listing

A P 2000 C CHARACTER GENERATOR LISTING

<u>CHARACTER</u>	<u>CHARACTER</u>	<u>GENERATOR</u>	<u>ROM</u>	<u>CONTENTS</u>	<u>UNDEFINED</u>
00	FF FF FF FF	FF FF FF FF	FF FF FF FF	FF FF FF FF	xx xx xx xx
01	FO FO FO FO	FF FF FF FF	FF FF FF FF	FF FF FF FF	xx xx xx xx
02	OF OF OF OF	FF FF FF FF	FF FF FF FF	FF FF FF FF	xx xx xx xx
03	OO OO OO OO	FF FF FF FF	FF FF FF FF	FF FF FF FF	xx xx xx xx
04	FF FF FF FF	FO FO FO FO	FF FF FF FF	FF FF FF FF	xx xx xx xx
05	FO FO FO FO	FO FO FO FO	FF FF FF FF	FF FF FF FF	xx xx xx xx
06	OF OF OF OF	FO FO FO FO	FF FF FF FF	FF FF FF FF	xx xx xx xx
07	OO OO OO OO	FO FO FO FO	FF FF FF FF	FF FF FF FF	xx xx xx xx
08	FF FF FF FF	OF OF OF OF	FF FF FF FF	FF FF FF FF	xx xx xx xx
09	FO FO FO FO	OF OF OF OF	FF FF FF FF	FF FF FF FF	xx xx xx xx
0A	OF OF OF OF	OF OF OF OF	FF FF FF FF	FF FF FF FF	xx xx xx xx
0B	OO OO OO OO	OF OF OF OF	FF FF FF FF	FF FF FF FF	xx xx xx xx
0C	FF FF FF FF	OO OO OO OO	FF FF FF FF	FF FF FF FF	xx xx xx xx
0D	FO FO FO FO	OO OO OO OO	FF FF FF FF	FF FF FF FF	xx xx xx xx
0E	OF OF OF OF	OO OO OO OO	FF FF FF FF	FF FF FF FF	xx xx xx xx
0F	OO OO OO OO	OO OO OO OO	FF FF FF FF	FF FF FF FF	xx xx xx xx
10	FF FF FF FF	FF FF FF FF	FO FO FO FO	FO FO FO FO	xx xx xx xx
11	FO FO FO FO	FF FF FF FF	FO FO FO FO	FO FO FO FO	xx xx xx xx
12	OF OF OF OF	FF FF FF FF	FO FO FO FO	FO FO FO FO	xx xx xx xx
13	OO OO OO OO	FF FF FF FF	FO FO FO FO	FO FO FO FO	xx xx xx xx
14	FF FF FF FF	FO FO FO FO	FO FO FO FO	FO FO FO FO	xx xx xx xx
15	FO FO FO FO	FO FO FO FO	FO FO FO FO	FO FO FO FO	xx xx xx xx
16	OF OF OF OF	FO FO FO FO	FO FO FO FO	FO FO FO FO	xx xx xx xx
17	OO OO OO OO	FO FO FO FO	FO FO FO FO	FO FO FO FO	xx xx xx xx
18	FF FF FF FF	OF OF OF OF	FO FO FO FO	FO FO FO FO	xx xx xx xx
19	FO FO FO FO	OF OF OF OF	FO FO FO FO	FO FO FO FO	xx xx xx xx
1A	OF OF OF OF	OF OF OF OF	FO FO FO FO	FO FO FO FO	xx xx xx xx
1B	OO OO OO OO	OF OF OF OF	FO FO FO FO	FO FO FO FO	xx xx xx xx
1C	FF FF FF FF	OO OO OO OO	FO FO FO FO	FO FO FO FO	xx xx xx xx
1D	FO FO FO FO	OO OO OO OO	FO FO FO FO	FO FO FO FO	xx xx xx xx
1E	OF OF OF OF	OO OO OO OO	FO FO FO FO	FO FO FO FO	xx xx xx xx
1F	OO OO OO OO	OO OO OO OO	FO FO FO FO	FO FO FO FO	xx xx xx xx
20	FF FF FF FF	FF FF FF FF	FF FF FF FF	FF FF FF FF	xx xx xx xx
21	FF E7 E7 E7	E7 E7 FF E7	FF FF FF FF	FF FF FF FF	xx xx xx xx
22	FF DB DB DB	FF FF FF FF	FF FF FF FF	FF FF FF FF	xx xx xx xx
23	FF DB 81 DB	DB 81 DB FF	FF FF FF FF	FF FF FF FF	xx xx xx xx
24	FF E7 83 E5	E3 C7 A7 C1	E7 FF FF FF	FF FF FF FF	xx xx xx xx
25	FF F9 B9 DF	EF F7 9B 9D	FF FF FF FF	FF FF FF FF	xx xx xx xx
26	FF F3 ED F3	F5 AD 9D 83	FF FF FF FF	FF FF FF FF	xx xx xx xx
27	FF F7 F7 F7	FF FF FF FF	FF FF FF FF	FF FF FF FF	xx xx xx xx

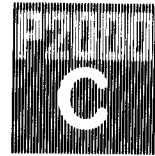

Character Generator Listing

<u>CHARACTER</u>	<u>CHARACTER</u>	<u>GENERATOR</u>	<u>ROM</u>	<u>CONTENTS</u>	<u>UNDEFINED</u>
28	FF EF F7 FB	FB FB F7 EF		FF FF FF FF	xx xx xx xx
29	FF F7 EF DF	DF DF EF F7		FF FF FF FF	xx xx xx xx
2A	FF FF D5 E3	C1 E3 D5 FF		FF FF FF FF	xx xx xx xx
2B	FF FF F7 F7	C1 F7 F7 FF		FF FF FF FF	xx xx xx xx
2C	FF FF FF FF	FF FF EF EF		EF F7 FF FF	xx xx xx xx
2D	FF FF FF FF	C3 FF FF FF		FF FF FF FF	xx xx xx xx
2E	FF FF FF FF	FF FF E7 E7		FF FF FF FF	xx xx xx xx
2F	FF FF BF DF	EF F7 FB FD		FF FF FF FF	xx xx xx xx
30	FF C3 BD BD	BD BD BD C3		FF FF FF FF	xx xx xx xx
31	FF DF CF D7	DF DF DF 8F		FF FF FF FF	xx xx xx xx
32	FF C3 BD BF	CF F7 FB 81		FF FF FF FF	xx xx xx xx
33	FF C3 BD BF	CF BF BD C3		FF FF FF FF	xx xx xx xx
34	FF DF CF D7	DB 81 DF DF		FF FF FF FF	xx xx xx xx
35	FF 81 FD C1	BF BF BD C3		FF FF FF FF	xx xx xx xx
36	FF C3 BD FD	C1 BD BD C3		FF FF FF FF	xx xx xx xx
37	FF 81 BF DF	EF F7 FB FB		FF FF FF FF	xx xx xx xx
38	FF C3 BD BD	C3 BD BD C3		FF FF FF FF	xx xx xx xx
39	FF C3 BD BD	83 BF BD C3		FF FF FF FF	xx xx xx xx
3A	FF FF FF F7	FF F7 FF FF		FF FF FF FF	xx xx xx xx
3B	FF FF FF FF	EF FF EF EF		EF F7 FF FF	xx xx xx xx
3C	FF FF F7 FB	FD FB F7 FF		FF FF FF FF	xx xx xx xx
3D	FF FF FF C3	FF C3 FF FF		FF FF FF FF	xx xx xx xx
3E	FF FF F7 EF	DF EF F7 FF		FF FF FF FF	xx xx xx xx
3F	FF C3 BD BF	CF F7 FF F7		FF FF FF FF	xx xx xx xx
40	FF FF FF C3	BD 85 B5 85		FD C3 FF FF	xx xx xx xx
41	FF E7 DB BD	BD 81 BD BD		FF FF FF FF	xx xx xx xx
42	FF C1 BD BD	C1 BD BD C1		FF FF FF FF	xx xx xx xx
43	FF C3 BD FD	FD FD BD C3		FF FF FF FF	xx xx xx xx
44	FF C1 BD BD	BD BD BD C1		FF FF FF FF	xx xx xx xx
45	FF 81 FD FD	C1 FD FD 81		FF FF FF FF	xx xx xx xx
46	FF 81 FD FD	C1 FD FD FD		FF FF FF FF	xx xx xx xx
47	FF C3 BD FD	8D BD BD 83		FF FF FF FF	xx xx xx xx
48	FF BD BD BD	81 BD BD BD		FF FF FF FF	xx xx xx xx
49	FF C7 EF EF	EF EF EF C7		FF FF FF FF	xx xx xx xx
4A	FF 81 BF BF	BF BF BD C3		FF FF FF FF	xx xx xx xx
4B	FF BD DD ED	F5 E9 DD BD		FF FF FF FF	xx xx xx xx
4C	FF FD FD FD	FD FD FD 81		FF FF FF FF	xx xx xx xx
4D	FF BD 99 A5	A5 BD BD BD		FF FF FF FF	xx xx xx xx
4E	FF BD B9 B5	AD 9D BD BD		FF FF FF FF	xx xx xx xx
4F	FF 81 BD BD	BD BD BD 81		FF FF FF FF	xx xx xx xx

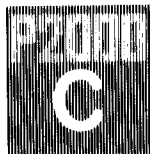

Character Generator Listing

<u>CHARACTER</u>	<u>CHARACTER</u>	<u>GENERATOR</u>	<u>ROM</u>	<u>CONTENTS</u>	<u>UNDEFINED</u>
50	FF C1 BD BD	C1 FD FD FD		FF FF FF FF	xx xx xx xx
51	FF 81 BD BD	BD AD 9D 81		FF FF FF FF	xx xx xx xx
52	FF C1 BD BD	C1 ED DD BD		FF FF FF FF	xx xx xx xx
53	FF C3 BD FB	E7 DF BD C3		FF FF FF FF	xx xx xx xx
54	FF 81 F7 F7	F7 F7 F7 F7		FF FF FF FF	xx xx xx xx
55	FF BD BD BD	BD BD BD C3		FF FF FF FF	xx xx xx xx
56	FF BD BD BD	BD BD DB E7		FF FF FF FF	xx xx xx xx
57	FF BD BD BD	A5 A5 99 BD		FF FF FF FF	xx xx xx xx
58	FF BD DB E7	E7 DB BD BD		FF FF FF FF	xx xx xx xx
59	FF BD BD DB	E7 F7 F7 F7		FF FF FF FF	xx xx xx xx
5A	FF 81 BF DF	EF F7 FB 81		FF FF FF FF	xx xx xx xx
5B	FF C3 FB FB	FB FB FB C3		FF FF FF FF	xx xx xx xx
5C	FF FF FD FB	F7 EF DF BF		FF FF FF FF	xx xx xx xx
5D	FF C3 DF DF	DF DF DF C3		FF FF FF FF	xx xx xx xx
5E	FF F7 EB DD	FF FF FF FF		FF FF FF FF	xx xx xx xx
5F	FF FF FF FF	FF FF FF 81		FF FF FF FF	xx xx xx xx
60	FF F7 EF DF	FF FF FF FF		FF FF FF FF	xx xx xx xx
61	FF FF FF A3	9D BD 9D A3		FF FF FF FF	xx xx xx xx
62	FF FD FD C5	B9 BD BD C1		FF FF FF FF	xx xx xx xx
63	FF FF FF C3	BD FD BD C3		FF FF FF FF	xx xx xx xx
64	FF BF BF A3	9D BD 9D A3		FF FF FF FF	xx xx xx xx
65	FF FF FF C3	BD 81 FD C3		FF FF FF FF	xx xx xx xx
66	FF CF B7 F7	81 F7 F7 F7		F7 F7 FF FF	xx xx xx xx
67	FF FF FF A3	9D BD 9D A3		BF BD C3 FF	xx xx xx xx
68	FF FD FD C5	B9 BD BD BD		FF FF FF FF	xx xx xx xx
69	FF EF FF E7	EF EF EF C7		FF FF FF FF	xx xx xx xx
6A	FF DF FF DF	DF DF DF DF		DF DB E7 FF	xx xx xx xx
6B	FF FD FD DD	ED F5 E9 DD		FF FF FF FF	xx xx xx xx
6C	FF FD FD FD	FD FD DD E3		FF FF FF FF	xx xx xx xx
6D	FF FF FF D5	A9 AD AD AD		FF FF FF FF	xx xx xx xx
6E	FF FF FF C5	B9 BD BD BD		FF FF FF FF	xx xx xx xx
6F	FF FF FF C3	BD BD BD C3		FF FF FF FF	xx xx xx xx
70	FF FF FF C5	B9 BD B9 C5		FD FD FF FF	xx xx xx xx
71	FF FF FF A3	9D BD 9D A3		BF BF FF FF	xx xx xx xx
72	FF FF FF C5	B9 FD FD FD		FF FF FF FF	xx xx xx xx
73	FF FF FF 83	FD C3 BF C1		FF FF FF FF	xx xx xx xx
74	FF FB FB C1	FB FB BB C7		FF FF FF FF	xx xx xx xx
75	FF FF FF BD	BD BD BD C3		FF FF FF FF	xx xx xx xx
76	FF FF FF BD	BD BD DB E7		FF FF FF FF	xx xx xx xx
77	FF FF FF BD	BD A5 A5 DB		FF FF FF FF	xx xx xx xx

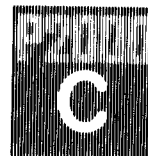

Character Generator Listing

<u>CHARACTER</u>	<u>CHARACTER</u>	<u>GENERATOR</u>	<u>ROM</u>	<u>CONTENTS</u>	<u>UNDEFINED</u>
78	FF FF FF BD	DB E7 DB BD		FF FF FF FF	xx xx xx xx
79	FF FF FF BD	DB E7 F7 FB		FD FF FF FF	xx xx xx xx
7A	FF FF FF 81	DF E7 FB 81		FF FF FF FF	xx xx xx xx
7B	FF F7 FB FB	FD FB FB F7		FF FF FF FF	xx xx xx xx
7C	FF F7 F7 F7	F7 F7 F7 F7		FF FF FF FF	xx xx xx xx
7D	FF F7 EF EF	DF EF EF F7		FF FF FF FF	xx xx xx xx
7E	FF B3 CD FF	FF FF FF FF		FF FF FF FF	xx xx xx xx
7F	FF FF BF B7	BB 81 FB F7		FF FF FF FF	xx xx xx xx
80	FF FF FF FF	FF FF FF FF		OF OF OF OF	xx xx xx xx
81	FO FO FO FO	FF FF FF FF		OF OF OF OF	xx xx xx xx
82	OF OF OF OF	FF FF FF FF		OF OF OF OF	xx xx xx xx
83	00 00 00 00	FF FF FF FF		OF OF OF OF	xx xx xx xx
84	FF FF FF FF	FO FO FO FO		OF OF OF OF	xx xx xx xx
85	FO FO FO FO	FO FO FO FO		OF OF OF OF	xx xx xx xx
86	OF OF OF OF	FO FO FO FO		OF OF OF OF	xx xx xx xx
87	00 00 00 00	FO FO FO FO		OF OF OF OF	xx xx xx xx
88	FF FF FF FF	OF OF OF OF		OF OF OF OF	xx xx xx xx
89	FO FO FO FO	OF OF OF OF		OF OF OF OF	xx xx xx xx
8A	OF OF OF OF	OF OF OF OF		OF OF OF OF	xx xx xx xx
8B	00 00 00 00	OF OF OF OF		OF OF OF OF	xx xx xx xx
8C	FF FF FF FF	00 00 00 00		OF OF OF OF	xx xx xx xx
8D	FO FO FO FO	00 00 00 00		OF OF OF OF	xx xx xx xx
8E	OF OF OF OF	00 00 00 00		OF OF OF OF	xx xx xx xx
8F	00 00 00 00	00 00 00 00		OF OF OF OF	xx xx xx xx
90	FF FF FF FF	FF FF FF FF		00 00 00 00	xx xx xx xx
91	FO FO FO FO	FF FF FF FF		00 00 00 00	xx xx xx xx
92	OF OF OF OF	FF FF FF FF		00 00 00 00	xx xx xx xx
93	00 00 00 00	FF FF FF FF		00 00 00 00	xx xx xx xx
94	FF FF FF FF	FO FO FO FO		00 00 00 00	xx xx xx xx
95	FO FO FO FO	FO FO FO FO		00 00 00 00	xx xx xx xx
96	OF OF OF OF	FO FO FO FO		00 00 00 00	xx xx xx xx
97	00 00 00 00	FO FO FO FO		00 00 00 00	xx xx xx xx
98	FF FF FF FF	OF OF OF OF		00 00 00 00	xx xx xx xx
99	FO FO FO FO	OF OF OF OF		00 00 00 00	xx xx xx xx
9A	OF OF OF OF	OF OF OF OF		00 00 00 00	xx xx xx xx
9B	00 00 00 00	OF OF OF OF		00 00 00 00	xx xx xx xx
9C	FF FF FF FF	00 00 00 00		00 00 00 00	xx xx xx xx
9D	FO FO FO FO	00 00 00 00		00 00 00 00	xx xx xx xx
9E	OF OF OF OF	00 00 00 00		00 00 00 00	xx xx xx xx
9F	00 00 00 00	00 00 00 00		00 00 00 00	xx xx xx xx



Character Generator Listing

<u>CHARACTER</u>	<u>CHARACTER</u>	<u>GENERATOR</u>	<u>ROM</u>	<u>CONTENTS</u>	<u>UNDEFINED</u>
A0	FF F7 EB DD	EB F7 FF FF		FF FF FF FF	xx xx xx xx
A1	FF E7 FF E7	E7 E7 E7 E7		FF FF FF FF	xx xx xx xx
A2	FF FF BF C3	AD F5 B9 C1		FF FF FF FF	xx xx xx xx
A3	FF C7 BB FB	E1 FB BB C5		FF FF FF FF	xx xx xx xx
A4	B3 CD FF 81	BD BD BD 81		FF FF FF FF	xx xx xx xx
A5	FF BD BD DB	E7 F7 C1 F7		FF FF FF FF	xx xx xx xx
A6	FF DB FF FF	FF FF FF FF		FF FF FF FF	xx xx xx xx
A7	FF C3 FD C3	BD C3 BF C1		FF FF FF FF	xx xx xx xx
A8	FF BD C3 DB	DB C3 BD FF		FF FF FF FF	xx xx xx xx
A9	FF FF FF FF	FF 07 F7 F7		F7 F7 F7 F7	xx xx xx xx
AA	F7 F7 F7 F7	F7 07 FF FF		FF FF FF FF	xx xx xx xx
AB	FF FF B7 DB	ED DB B7 FF		FF FF FF FF	xx xx xx xx
AC	FF FF FF F7	FB 81 FB F7		FF FF FF FF	xx xx xx xx
AD	FF F7 E3 D5	F7 F7 F7 F7		FF FF FF FF	xx xx xx xx
AE	FF FF FF EF	DF 81 DF EF		FF FF FF FF	xx xx xx xx
AF	FF F7 F7 F7	F7 D5 E3 F7		FF FF FF FF	xx xx xx xx
B0	FF C7 BB BB	C7 FF FF FF		FF FF FF FF	xx xx xx xx
B1	FF F7 F7 C1	F7 F7 FF C1		FF FF FF FF	xx xx xx xx
B2	CF B7 DF EF	87 FF FF FF		FF FF FF FF	xx xx xx xx
B3	CF B7 DF B7	CF FF FF FF		FF FF FF FF	xx xx xx xx
B4	FF FF BB D7	EF D7 BB FF		FF FF FF FF	xx xx xx xx
B5	FF FF FF BB	BB BB BB 43		FB FB FB FF	xx xx xx xx
B6	FF D3 D1 D1	D3 D7 D7 D7		FF FF FF FF	xx xx xx xx
B7	B3 CD FF C3	BD BD BD C3		FF FF FF FF	xx xx xx xx
B8	FF FF FF F7	FF C1 FF F7		FF FF FF FF	xx xx xx xx
B9	FF FF FF FF	FF F0 F7 F7		F7 F7 F7 F7	xx xx xx xx
BA	F7 F7 F7 F7	F7 F0 FF FF		FF FF FF FF	xx xx xx xx
BB	FF FF ED DB	B7 DB ED FF		FF FF FF FF	xx xx xx xx
BC	FB F9 7A BB	DB EF B7 9B		AD 06 BF FF	xx xx xx xx
BD	FB F9 7A BB	DB EF B7 5B		7D BE 1F FF	xx xx xx xx
BE	F9 F6 7B B6	D9 EF B7 9B		AD 06 BF FF	xx xx xx xx
BF	FF EF FF EF	F3 FD BD C3		FF FF FF FF	xx xx xx xx
C0	FF 7F BF 81	EF 81 FB FD		FF FF FF FF	xx xx xx xx
C1	EF F7 FF C3	BD BD 81 BD		FF FF FF FF	xx xx xx xx
C2	FF EF F7 FB	FF FF FF FF		FF FF FF FF	xx xx xx xx
C3	F7 EF FF C3	BD BD 81 BD		FF FF FF FF	xx xx xx xx
C4	E7 DB FF C3	BD BD 81 BD		FF FF FF FF	xx xx xx xx
C5	DB FF C3 BD	BD 81 BD BD		FF FF FF FF	xx xx xx xx
C6	EF F7 FF 81	FD C1 FD 81		FF FF FF FF	xx xx xx xx
C7	F7 EF FF 81	FD C1 FD 81		FF FF FF FF	xx xx xx xx

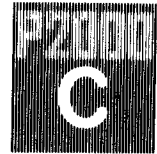

Character Generator Listing

<u>CHARACTER</u>	<u>CHARACTER</u>	<u>GENERATOR</u>	<u>ROM</u>	<u>CONTENTS</u>	<u>UNDEFINED</u>
C8	E7 DB FF 81	FD C1 FD 81		FF FF FF FF	xx xx xx xx
C9	F7 F7 F7 F7	F7 07 F7 F7		F7 F7 F7 F7	xx xx xx xx
CA	FF FF FF FF	FF 00 F7 F7		F7 F7 F7 F7	xx xx xx xx
CB	DF EF FF C7	EF EF EF C7		FF FF FF FF	xx xx xx xx
CC	F7 EF FF C7	EF EF EF C7		FF FF FF FF	xx xx xx xx
CD	FF EB FF E3	F7 F7 F7 E3		FF FF FF FF	xx xx xx xx
CE	FF C3 BD FD	FD FD BD C3		EF DF E7 FF	xx xx xx xx
CF	B3 CD FF B9	B5 AD 9D BD		FF FF FF FF	xx xx xx xx
D0	FF FF FF FF	FF 00 FF FF		FF FF FF FF	xx xx xx xx
D1	EF F7 FF A3	9D BD 9D A3		FF FF FF FF	xx xx xx xx
D2	F7 EB FF F3	F7 F7 F7 E3		FF FF FF FF	xx xx xx xx
D3	F7 EF FF A3	9D BD 9D A3		FF FF FF FF	xx xx xx xx
D4	E7 DB FF A3	9D BD 9D A3		FF FF FF FF	xx xx xx xx
D5	FF DB FF A3	9D BD 9D A3		FF FF FF FF	xx xx xx xx
D6	EF F7 FF C3	BD 81 FD C3		FF FF FF FF	xx xx xx xx
D7	F7 EF FF C3	BD 81 FD C3		FF FF FF FF	xx xx xx xx
D8	E7 DB FF C3	BD 81 FD C3		FF FF FF FF	xx xx xx xx
D9	F7 F7 F7 F7	F7 F0 F7 F7		F7 F7 F7 F7	xx xx xx xx
DA	F7 F7 F7 F7	F7 00 FF FF		FF FF FF FF	xx xx xx xx
DB	F7 FB FF F3	F7 F7 F7 E3		FF FF FF FF	xx xx xx xx
DC	FB F7 FF F3	F7 F7 F7 E3		FF FF FF FF	xx xx xx xx
DD	FF EB FF F3	F7 F7 F7 E3		FF FF FF FF	xx xx xx xx
DE	FF FF FF E3	DD FD DD E3		F7 EF F3 FF	xx xx xx xx
DF	B3 CD FF C5	B9 BD BD BD		FF FF FF FF	xx xx xx xx
E0	FF C3 BD BD	BD DB DB 99		FF FF FF FF	xx xx xx xx
E1	FF 03 ED ED	8D E1 ED 0D		FF FF FF FF	xx xx xx xx
E2	E7 DB E7 DB	BD 81 BD BD		FF FF FF FF	xx xx xx xx
E3	FF A3 9D 9D	A3 FF 81 FF		FF FF FF FF	xx xx xx xx
E4	F7 EB FF 81	BD BD BD 81		FF FF FF FF	xx xx xx xx
E5	DB FF 81 BD	BD BD BD 81		FF FF FF FF	xx xx xx xx
E6	EF F7 FF 81	BD BD BD 81		FF FF FF FF	xx xx xx xx
E7	F7 EF FF 81	BD BD BD 81		FF FF FF FF	xx xx xx xx
E8	EF F7 BD BD	BD BD BD C3		FF FF FF FF	xx xx xx xx
E9	7F 81 9D AD	B5 B9 BD 80		FF FF FF FF	xx xx xx xx
EA	F7 F7 F7 F7	F7 00 F7 F7		F7 F7 F7 F7	xx xx xx xx
EB	FF C3 BD BD	C3 FF 81 FF		FF FF FF FF	xx xx xx xx
EC	F7 EF BD BD	BD BD BD C3		FF FF FF FF	xx xx xx xx
ED	DB FF BD BD	BD BD BD C3		FF FF FF FF	xx xx xx xx
EE	B3 CD FF C3	BD BD 81 BD		FF FF FF FF	xx xx xx xx
EF	FF FF FF C3	C3 FF FF FF		FF FF FF FF	xx xx xx xx

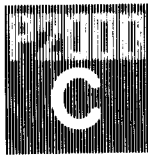

Character Generator Listing

<u>CHARACTER</u>	<u>CHARACTER</u>	<u>GENERATOR</u>	<u>ROM</u>	<u>CONTENTS</u>	<u>UNDEFINED</u>
F0	FF DB FF C3	BD 91 FD C3		FF FF FF FF	xx xx xx xx
F1	FF FF FF C9	B7 C1 F6 C9		FF FF FF FF	xx xx xx xx
F2	E7 DB E7 A3	9D BD 9D A3		FF FF FF FF	xx xx xx xx
F3	F7 EB FF DD	DD DD DD E3		FF FF FF FF	xx xx xx xx
F4	E7 DB FF C3	BD BD BD C3		FF FF FF FF	xx xx xx xx
F5	FF DB FF C3	BD BD BD C3		FF FF FF FF	xx xx xx xx
F6	EF F7 FF C3	BD BD BD C3		FF FF FF FF	xx xx xx xx
F7	F7 EF FF C3	BD BD BD C3		FF FF FF FF	xx xx xx xx
F8	EF F7 FF BD	BD BD BD C3		FF FF FF FF	xx xx xx xx
F9	FF FF BF C3	AD B5 B9 C1		FE FF FF FF	xx xx xx xx
FA	F7 F7 F7 F7	F7 F7 F7 F7		F7 F7 F7 F7	xx xx xx xx
FB	FF C3 BD BD	CD BD BD CD		FD FF FF FF	xx xx xx xx
FC	FF F7 EF BD	BD BD BD C3		FF FF FF FF	xx xx xx xx
FD	FF DB FF BD	BD BD BD C3		FF FF FF FF	xx xx xx xx
FE	B3 CD FF A3	9D BD 9D A3		FF FF FF FF	xx xx xx xx
FF	FF FF FF E7	E7 FF FF FF		FF FF FF FF	xx xx xx xx





Basic Program Using Polar Co-ordinates

B

USING POLAR CO-ORDINATES

```

10 ' THIS PROCEDURE USES DIRECT CONOUT
20 ' XYZ WRITES 2 BYTE X COORDINATE AND 1 BYTE Y COORDINATE
30 '-----
40 '
50 DATA &H4E:'          LD      C,(HL) ;GET X LOW BYTE
60 DATA &HCD,&HOE,&HDO:' CALL    OUTBYTE  000E
70 DATA &H23:'          INC     HL
80 DATA &H4E:'          LD      C,(HL) ;GET X HIGH BYTE
90 DATA &HCD,&HOE,&HDO:' CALL    OUTBYTE
100 DATA &HEB:'         EX      DE,HL
110 DATA &H4E:'         LD      C,(HL) ;GET Y
120 DATA &HC3,&HOE,&HDO:' JP      OUTBYTE
130 '
140 DATA &HE5:'         OUTBYTE:PUSH HL
150 DATA &HD5:'         PUSH   DE
160 DATA &H2A,1,0:'     LD      HL,(1) ;CBIOS JUMP TABLE ADDR.
170 DATA &H11,9,0:'     LD      DE,9 ;OFFSET TO CONOUT
180 DATA &H19:'         ADD    HL,DE
190 DATA &H11,&H1C,&HDO:' LD      DE,RETX ;RETURN ADDRESS FOR CONOUT
200 DATA &HD5:'         PUSH   DE
210 DATA &HE9:'         JP      (HL) ;CALL CONOUT
220 DATA &HD1:'         RETX:  POP   DE
230 DATA &HE1:'         POP    HL
240 DATA &HC9:'         RET
250 DATA &HFF
260 '-----
270 XY=&HD000
280 CLEAR ,XY,250
290 XY=&HD000
300 IX=0
310 WHILE+ KZ<=&HFF
320     READ KZ:POKE &HD000+IX,KZ:IX=IX+1
330 WEND
340 ' THIS PROCEDURE USES DIRECT CONOUT
350 ' XYZ WRITES 2 BYTE ANGLE AND 2 BYTE ABS. VALUE
360 '-----
370 '
380 DATA &H4E:'          LD      C,(HL) ;GET X LOW BYTE
390 DATA &HCD,&H10,&HD1:' CALL    OUTBYTE
400 DATA &H23:'          INC     HL
410 DATA &H4E:'          LD      C,(HL) ;GET X HIGH BYTE
420 DATA &HCD,&H10,&HD1:' CALL    OUTBYTE
430 DATA &HEB:'         EX      DE,HL
440 DATA &H4E:'         LD      C,(HL) ;GET Y
450 DATA &HCD,&H10,&HD1:' CALL    OUTBYTE
460 DATA &H23,&H4E:'     INC HL + LD C,(HL)
470 DATA &HE5:'         OUTBYTE:PUSH HL
480 DATA &HD5:'         PUSH   DE
490 DATA &H2A,1,0:'     LD      HL,(1) ;CBIOS JUMP TABLE ADDR.
500 DATA &H11,9,0:'     LD      DE,9 ;OFFSET TO CONOUT
510 DATA &H19:'         ADD    HL,DE

```

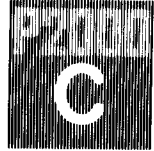

Basic Program Using Polar Co-ordinates

```

520 DATA &H11,&H1E,&HD1:'          LD      DE,RETX ;RETURN ADDRESS FOR CONOUT
530 DATA &HD5:'                    PUSH   DE
540 DATA &HE9:'                    JP      (HL) ;CALL CONOUT
550 DATA &HD1:'          RETX:      POP    DE
560 DATA &HE1:'                    POP    HL
570 DATA &HC9:'          RET
580 DATA &HFF
590 '-----
600 PXI=&HD100
610 IX=0:KX=0
620 WHILE+ KX<=&HFF
630      READ KX:POKE &HD100+IX,KX:IX=IX+1
640 WEND
650 WIDTH 255:PRINT CHR$(12)+CHR$(27)+"3";
660 OG$=CHR$(27)+"z":MT$=CHR$(27)+"y":DT$=CHR$(27)+"u"
670 FOR OX%=80 TO 450 STEP 120 ' DISTANCE IN X-AXIS
680 FOR OY%=50 TO 200 STEP 120 ' DISTANCE IN Y-AXIS
690 PRINT OG$;:CALL XY(OX%,OY%)
700 GOSUB 750
710 NEXT
720 NEXT
730 REM -----
740 K$=INKEY$:IF K$="" THEN 740 ELSE PRINT CHR$(27)+"4":END
750 REM
760 AB%=50
770 FOR AX%=0 TO 360 STEP 60
780 PRINT MT$;:CALL PXI(AX%,AB%)
790 AX%=AX%
800 FOR IX=1 TO 3 '          NUMBER OF TURNS
810 AX%=AX%+90:PRINT-DT$;:CALL PXI(AX%,AB%)
820 NEXT
830 NEXT
840 RETURN

```

Manual Status Control Form

P2000C SYSTEM REFERENCE AND SERVICE MANUAL

12 NC: 5103 993 30422

This issue comprises the following updates:

Amendment List 1

Significant changes to the text (or illustrations) are marked with a line in the outer margin.
The deletion of text is marked with '*'.



Manual Comment Form

P2000C SYSTEM REFERENCE AND SERVICE MANUAL

12 NC: 5103 993 30422

Including updates: All, _ _ _ _

Originator:

Name:

Address:.....

.....

.....

Comment (if possible, please add a copy of the page(s) affected by the comment, marked with the proposed changes.

Please return this form to: Mr J. Stransky - Service Manager
Österreichische Philips Industrie GmbH
Elektronikfabrik-Microelectronics Wien
Breitenseer Strasse 116
A-1140 WIEN
AUSTRIA



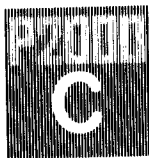

Maintenance Facilities

Special Note

The P2000C Maintenance Program is supplied on a 160K Diskette.

To produce a stand-alone Maintenance Diskette (160K or 640K - depending on your system) the following procedure should be followed:

1. Place SYSTEM DISKETTE in DRIVE 1
2. Place EMPTY 640K (or 160K) FORMATTED DISK in DRIVE 2
3. RESET
4. Call CONFIG
 - Enter SYSTEM CONFIGURATION (1) and select appropriate configuration. Press "Carriage Return".
 - Set CAPSLOCK and PRINTER TIMEOUT as required.
 - Enter AUTOSTART STRING as MN11.
 - Enter MESSAGE as required.
 - Enter 2 for FLOPPY DRIVE TO WRITE NEW SYSTEM - CONFIRM
5. RESET
6. Call UTIL
 - Define LANGUAGE AND FLOPPY ARRANGEMENT (POINT 4)
 - Select appropriate Drives.
 - The MENU will be displayed.
 - Select COPY FLOPPY
 - Enter SOURCE = 1 - DESTINATION = 2
 - Enter "YES" to Verify.
 - Select SOURCE DISK TYPE 2 (160K)
 - Select SYSTEM = CP/M

!!! REMOVE SYSTEM DISK AND INSERT 160K MN11 IN DRIVE 1 !!!

- PRESS ANY KEY
 - Enter N(o) to NEXT COPY
 - Enter ESC
7. Remove and store the 160K diskette from DRIVE 1 (MN11).
 8. The diskette in DRIVE 2 is your Maintenance Diskette and may be booted in the usual way.



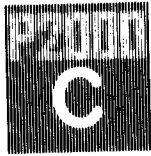

Maintenance Facilities

Contents

	Page
1 INTRODUCTION	C-1
2 MAINBOARD TEST	C-1
2.1 General	C-1
2.2 Memory and Peripheral Debugger	C-2
2.2.1 Command C: - COMPARE MEMORY BLOCKS	C-2
2.2.2 Command D: - DISPLAY MEMORY BLOCKS	C-2
2.2.3 Command DR: - DISK READ TRACK	C-3
2.2.4 Command DW: - DISK WRITE TRACK	C-3
2.2.5 Command F: - FILL MEMORY BLOCK WITH ONE BYTE	C-3
2.2.6 Command G: - GO TO AN ADDRESS (CALL A PROGRAM)	C-4
2.2.7 Command M: - MOVE MEMORY BLOCK	C-4
2.2.8 Command P: - PORT READ/WRITE	C-4
2.2.9 Command PS: - PRINTER SWITCH	C-4
2.2.10 Command S: - SET MEMORY	C-5
2.2.11 Command SK: - SEEK STRING IN MEMORY	C-5
3 TERMINALBOARD TEST	C-6
4 MAINTENANCE PROGRAM	C-7
4.1 Main Testing Program	C-8
4.1.1 Memory Test	C-8
Test Patterns	C-12
Test Algorithm	C-12
4.1.2 Floppy Disk Test	C-13
Read Master Floppy	C-13
Write-Read Test Floppy	C-14
Testing Pattern	C-15
Error Messages	C-16
Copy Floppy 1 to 2	C-18
Compare Floppies	C-18
4.1.3 Keyboard Test	C-19

Maintenance Facilities

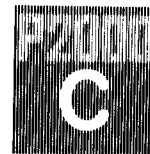

	Page
Main Testing Program (continued)	
4.1.4 Screen Test	C-19
Alphanumeric Test	C-19
Graphics (Mosaic Graphics) Test	C-20
High Resolution Graphics Test	C-20
Screen Adjustment Test	C-20
Special Features	C-20
4.1.5 Printer Character Test	C-21
4.1.6 Beeper Test	C-21
4.1.7 Summary	C-21
4.1.8 Debugger	C-22
4.2 Terminal Board Memory Test	C-22
4.3 Hard Disk Test	C-23
4.3.1 General Test Philosophy	C-23
4.3.2 Selectable Tests	C-25
XEDEC Controller Internal Diagnostics	C-25
Select Drive and Short Test	C-25
Drive Read Only Test	C-26
Drive Write-Read Test	C-26
4.4 Memory Extension Board Test	C-26
Memory Write-Read Test	C-26
Bank Switching Test	C-28
4.5 Parallel (IEC) Board Test	C-28
4.5.1 Standard Parallel (IEC) Board Test	C-29
4.5.2 Continuous Test Without Plug	C-30
4.5.3 Continuous Test With Plug	C-30
4.6 Reconfigure Maintenance Program	C-31
4.7 Burn-in Test	C-32
4.8 Short Burn-in Test	C-32



Preface

PREFACE

This manual describes the internal structure, function and operation of the Philips P2000C Portable Computer. The manual aims to provide the reader with sufficient technical information concerning the standard and optional hardware, the basic input/output operating system (BIOS) and the terminal firmware, so as to allow operation and servicing of the equipment. The manual includes a comprehensive Spare Part Catalogue with instructions for ordering.

The manual covers the anticipated needs of a wide range of readers, from the user who requires a basic understanding of how the system works to the service technician who may need very detailed technical information concerning the hardware of the machine. For this reason some of the information contained in the manual may appear redundant.

The P2000C uses a number of commercially available integrated circuits, such as the Z80-A CPU, and the reader may find it necessary to consult some of the existing documentation which is available for these products. Where practicable, reference to such documentation has been included in the text.

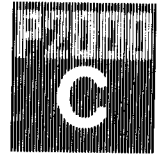

Preface

Page Layout

This manual has been arranged in four parts with the pages arranged as follows, giving a unique reference to each page:

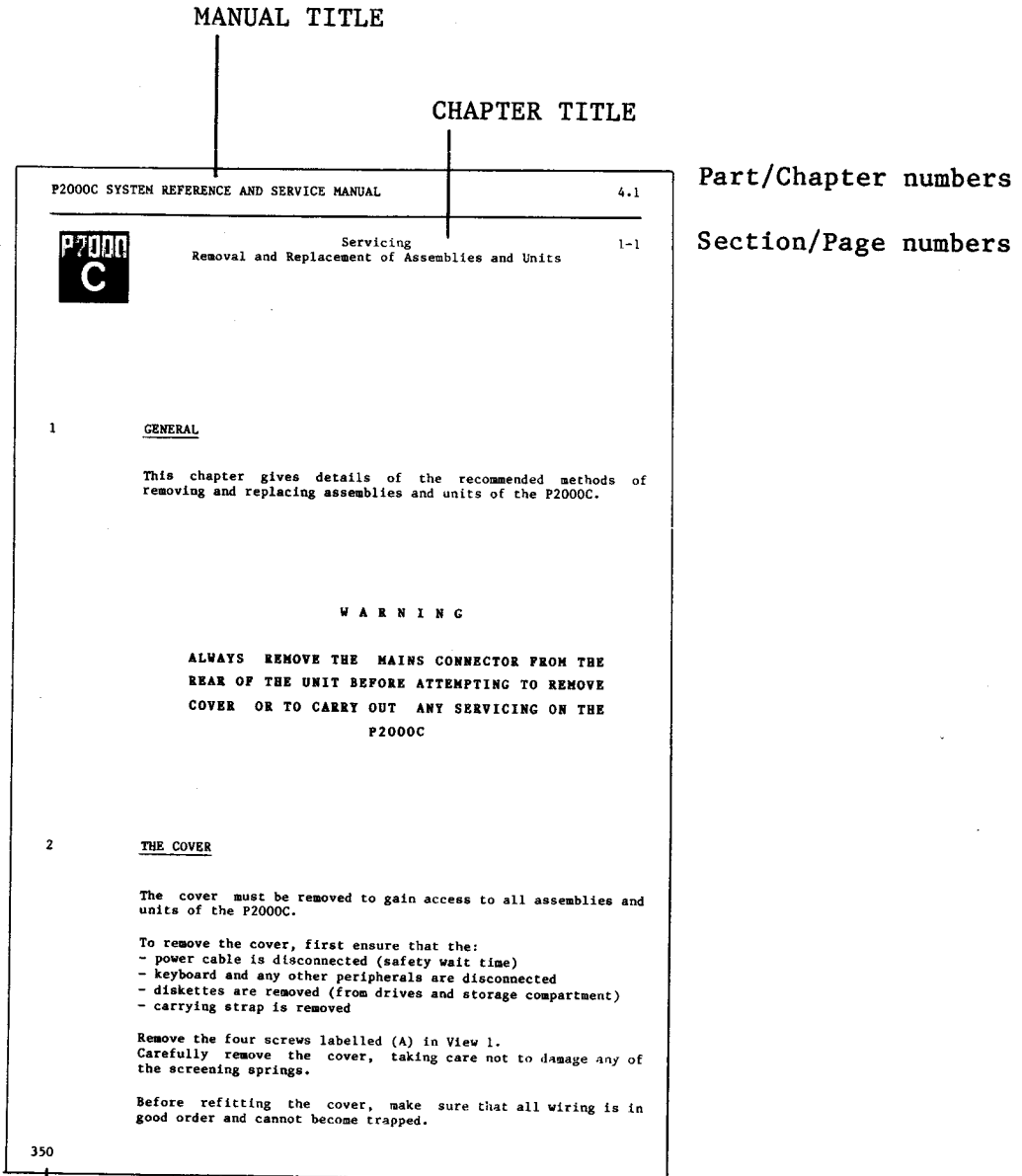

Update information

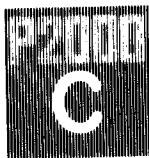

Maintenance Facilities

1 INTRODUCTION

The maintenance utilities of the P2000C are in three parts:

1. Mainboard Test resident in the IPL PROM.
2. Terminalboard Test resident in the Terminal ROM.
3. The Maintenance Program in CP/M files.

Each part will be described in the following paragraphs.

2 MAINBOARD TEST2.1 General

At switch-on, a ROM test is carried out and then the Initial Program Load is executed. If this is not successful (if there is no system diskette inserted and/or the hard disk is not at full speed) the message 'SYSTEM DISK?' is displayed.

The MEMORY AND PERIPHERAL DEBUGGER can then be activated by pressing the ESC key.

This situation can also be reached when no system disk is present at CP/M warm boot time by entering 'CTRL-C'. In the first case ASCII keyboard and screen is assumed and the printer speed is 1200 baud, in the second case the values configured on the CP/M system disk are valid.

The aim of this module is to help troubleshooting. Even if booting is impossible, it enables the user to make a short check of memory, ports, floppy disk, hard disk, video, keyboard and printer.

Maintenance Facilities

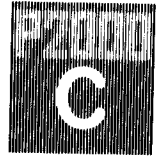

2.2 The Memory and Peripheral Debugger

The program prompt message will be as follows:

```
'COMMANDS: C,D,DR,DW,F,G,M,P,PS,S,SK  
ENTRY: Command Start_address End_address Other_info'
```

The command code may be followed by a space (not necessary). The separator between the operands may be a space or a comma. An automatic caps-lock function is implemented, i.e., lower case characters cannot be entered.

The syntax is similar to that of the DDT of Digital Research. The command line format differs from that in the P2000 and P2500 Maintenance Program Debugger due to compatibility with Digital Research's Symbolic Debugger.

To exit the debugger, enter the command 'G 0' (zero), 'CR' and any two characters; or simply press the RESET button.

The commands, with examples, are shown below. 'CR' indicates the CARRIAGE RETURN key.

2.2.1 COMMAND C: - COMPARE MEMORY BLOCKS

Example: C 4000 4FFF 5000

This command will compare the block 4000 - 4FFF with the block 5000 - 5FFF. Any differences will be displayed.

2.2.2 COMMAND D: - DISPLAY MEMORY BLOCKS

Example: D 6000 607F

The content of locations 6000 to 607F is displayed (HEX and ASCII).

The program stores the last displayed address and the length of the block. Therefore, to see the next block (6080 to 60FF), the user has only to type D and 'CR'.

D and 'CR' as an initial entry displays the contents of locations 4000 to 40FF. (4000 is the first address of the default disk buffer).

After a disk operation the base address is set to the disk buffer address.

A long display may be stopped and restarted with CTRL-S. Any other character cancels the command.

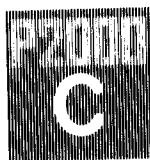

Maintenance Facilities

2.2.3 COMMAND DR: - DISK READ TRACK

Example: DR 126 5000

Reads the contents of drive 1 - track 26 (decimal) to memory locations 5000 to 5FFF.

The first digit indicates the drive number in accordance with the following table:

- 1 = Floppy-1; first side
- 2 = Floppy-2; first side
- 3 = Floppy-3; first side
- 4 = Floppy-4; first side
- 5 = Floppy-1; second side
- 6 = Floppy-2; second side
- 7 = Floppy-3; second side
- 8 = Floppy-4; second side
- 9 = Hard disk-1

The second and third digits give the physical track number in decimal. For floppies this must be between 0 and 79. For hard disk the track number must be between 0 and 99 (i.e., only a small part of the hard disk can be read in this way).

If a destination buffer is not given, location 4000 is assumed.

After issuing this command, a CONTINUOUS read operation is carried out on the designated track until any key is pressed. The result of each read operation is displayed. This will be in the form of 'OK' if the track is read correctly or the uPD765 Floppy Controller RESULT Byte in case of error. For a Hard disk error, this result byte has no significance.

2.2.4 COMMAND DW: - DISK WRITE TRACK

Example: DW 69

Data from locations 4000 to 4FFF is written to Floppy-2; second side, track 9. Drive, side and track information is entered in the same form as for DISK READ TRACK.

2.2.5 COMMAND F: - FILL MEMORY BLOCK WITH ONE BYTE

Example: F 8233 875D 55

The memory locations 8233 to 875D will be filled with 55H.

Maintenance Facilities

**2.2.6** **COMMAND G: - GO TO AN ADDRESS (CALL A PROGRAM)**

Example: G 5000

The user can enter small programs with the S(et) command (starting at location 5000 in the example) and execute them with the 'G' command. The C9 (RET) instruction at the end of the user program leads back to the Debugger.

2.2.7 **COMMAND M: - MOVE MEMORY BLOCK**

Example: M 4000 4FFF 5000

The block 4000 - 4FFF is copied to 5000 - 5FFF.

2.2.8 **COMMAND P: - PORT READ/WRITE**

Example: P 2A

The port 2A is read. The user can then enter a byte to be output to the port, followed by 'CR'. Subsequent 'CR's will display each port in turn, enter 'CR' if nothing is to be output. To cancel the command, enter '.' and 'CR'.

The command P 'CR' displays the complete port map.

2.2.9 **COMMAND PS: - PRINTER SWITCH**

After entering the command PS, all further information will be printed as well as displayed. A second PS command will cancel the function.

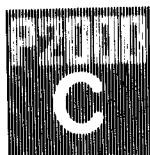

Maintenance Facilities

2.2.10 COMMAND S: - SET MEMORY

Example: S 4000

The entered start address and its contents will be displayed.

4000 21 - original contents 21H

The contents can be altered [enter new value], or left unchanged [enter 'CR']. The next address will then be displayed. To cancel the command, enter '.'

4000	21	31	- changes contents to 31H
4001	00	10	- changes contents to 10H
4002	50	CR	- leaves contents as 50H
4003	32	3A	- changes contents to 3AH
4004	55	.	- cancels command

2.2.11 COMMAND SK: - SEEK STRING IN MEMORY

Example: SK CD F9 F6

All addresses where the string 'CD F9 F6' occur are displayed.

Maintenance Facilities

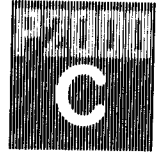
3 TERMINALBOARD TEST

After the port setup, the terminalboard attempts to send two characters to the mainboard and the mainboard should send them back. If this does not happen, the message SYSTEM ERROR! is displayed by the terminal program.

If the ESC key is pressed at the same time as the RESET, the ROM-resident terminal test program is activated. It has two parts:

1. ROM Checksum Test
2. Simple RAM Test

If ready, the OK or the error message is displayed and in case of error, the test stops. If no error is found, the test is repeated continuously until a key is pressed (it is a very simple keyboard test). The normal terminal operation is then restored.

A more sophisticated terminalboard memory test can be loaded from the mainboard maintenance program.



Maintenance Facilities

4

MAINTENANCE PROGRAM

The following files constitute the Maintenance Program and will be present on the diskette which is part of the P2599:

MN11.COM MN11.OVL MTS.HEX MTL.HEX MTL100.HEX

The main part of the program is called MN11.COM (Version 1.1). It can be activated in the CP/M environment by typing MN11 and pressing the 'CR' key. This part resides in locations 100 to 2FFF. The second part of the program is MN11.OVL. It contains the extension tests and resides in locations 8000 to BFFF. To start the program, both parts must be present on the same disk. The MTS.HEX and MTL.HEX files contain the terminalboard memory test. The MTL100.HEX file contains information required for the terminalboard burn-in test.

At the very first loading of the program the self-configuring part is activated automatically (see 4.6) and the disk must be write enabled.

On start-up a menu is displayed with the following options:

- 1 - MAIN TESTING PROGRAM
- 2 - TERMINAL BOARD MEMORY TEST
- 3 - HARD DISK TEST
- 4 - MEMORY EXTENSION BOARD TEST
- 5 - PARALLEL (IEC) BOARD TEST
- 6 - RECONFIGURE MAINTENANCE PROGRAM
- 7 - BURN-IN TEST
- 8 - SHORT BURN-IN TEST

After executing any item except a memory test in the Main Testing Program, this menu is displayed again. After returning from the main testing program, if a memory test has been executed, the loading disk must be in the original drive (to reload CP/M and the overlay that have been destroyed during the memory test).

When a test is completed the results are displayed on the screen. If a printer is connected the results are also printed.

Note: The checksum is only calculated when a MEMORY TEST is carried out! Perform a MEMORY TEST (from the Main Testing Program) before carrying out any other test using MN11.

Maintenance Facilities

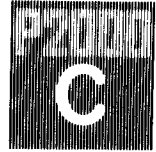
4.1 Main Testing Program

Selection of the Main Testing Program produces the following menu:

```
SELECT TEST:
1 - MEMORY
2 - DISK
3 - KEYBOARD
4 - SCREEN
5 - PRINTER
6 - BEEPER
7 - SUMMARY
8 - DEBUGGER
```

Each item is a sub-routine and after execution the menu will be displayed again.

4.1.1 1. MEMORY TEST

Within the memory test, the following options are offered:

```
MEMORY TEST:
1 - SHORT
2 - LONG
3 - SHORT MEM-COMM-FLOPPY-TEST
4 - LONG MEM-COMM-FLOPPY TEST
```

The short test gives a good indication of 'hard' memory errors within a few seconds.

The long test applies a stronger thermal load on the memory cells and can detect errors that are more difficult to find. The difference between the two tests is in the testing pattern and the test algorithm. In the combined tests (3 and 4) the memory test is followed by a very critical test for memory and DMA.

Before the test the checksum of the program range is computed. It is tested after each step of the test. In the event of an error, the following message is displayed:

```
'CHECKSUM ERROR IN SYSTEM RANGE, PROGRAM DAMAGED!!!'
```

and the program stops.

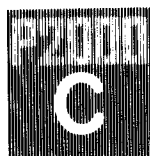

Maintenance Facilities

The testing procedure is as follows:

- a. The BIOS is shifted down (under 4000H).
- b. Locations 0 - 3FFF are shifted up to C000 - FFFF
- c. Locations 0 - BFFF are filled with the test pattern, checked, inverted and checked again.
- d. The range C000 - FFFF is shifted down to 0 - 3FFF.
- e. The locations above 4000H are filled with the test pattern.
- f. The locations above 4000H are checked, inverted and checked again.
- g. The BIOS is restored.

During testing, the following characters are displayed:

F = filling; T = testing; I = inverting

For the combined test, the following procedure is added. The user should insert (scratch) testing disks into both drives. A 'test' communications connector should be fitted, with the following interconnections:

[2-3], [4-5], [8-20], [15-17-24]

Note: This is different to previous versions, please check your connector.

Maintenance Facilities

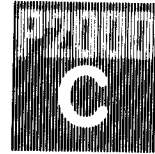

- h. The drives are checked for ready. If either drive is not ready, the program stops. Pressing any key will return to the main menu in 4.1. If a CP/M disk is inserted, the program asks:

DESTROY CP/M DISK? (Y/N)

The only answer that will be accepted is Y(es)!
If you wish to retain your CP/M disk you may exchange it for another (scratch) disk or press RESET.

A character is then sent through the communications connector and checked for correct reception. In the event of an error, one of the following messages is displayed:

COMMUNICATION CONNECTOR (SHORTS: 2-3, 4-5, 8-20, 15-17-24) MISSING

or

WRONG DATA ON SIO

In either case the message is followed by two hexadecimal bytes displaying the SIO status and data registers respectively.

- i. The SIO channel-A is programmed for DMA transfer and the memory with the test pattern is transferred through the communication connector to a 100H byte long temporary buffer. During the transfer the previously transferred block is recorded to disk and a text line is displayed:

COMMUNICATION AND FLOPPY WRITE

It means that all four channels of the DMA are active at the same time! For short test 16 blocks are transferred, for long tests 183 (decimal) blocks.

- j. The memory is checked.
- k. The disk is read back to the original locations (the message 'R' is displayed) and the memory is checked again.

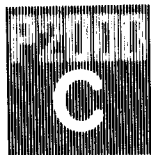

Maintenance Facilities

To assist troubleshooting a special display format has been selected to summarize all error cases.

For example, suppose the following errors have been found:

Address	Expected	Read
10101000 00000000	0 0 0 1 0 1 0 0	1 0 1 0 1 0 0 0
10101111 11111111	1 1 1 0 1 0 1 1	<u>1</u> <u>0</u> <u>1</u> <u>1</u> <u>0</u> <u>1</u> <u>1</u> <u>1</u>

The resulting error message would be:

ERROR AT ADDRESS: 10101XXX XXXXXXXX BITS: 101XXXGG

The symbols summarise the condition of the corresponding bits:

- 0: if error found, the bit is always set at 0
- 1: if error found, the bit is always set at 1
- X: if error found, the bit was set at 0 or 1
- G: no errors found on this bit (always Good - only in DATA field)

The error message above has the following meaning:

Errors have been found in the range A800 to AFFF

- When bits 7 & 5 were incorrect, they were always set to 1
- When bit 6 was incorrect, it was always set to 0
- When bits 2, 3 & 4 were incorrect, they were sometimes 1 and sometimes 0
- No errors were found in bits 0 or 1

If any error has been detected, and the printer is not connected, the procedure stops. At 'no error', a wait loop of 10 seconds is started. During that time the user can discontinue testing by entering '0' (zero), otherwise the procedure is repeated.

Maintenance Facilities

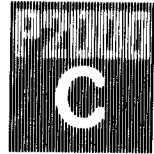

4.1.1.1 Test Patterns

Short test: The first byte is 93. It is rotated one position left and written to the next address, and so on... One permutation (C9) is excluded to achieve a 7 byte cycle:

93, 27, 4E, 9C, 39, 72, E4

Long test: The first byte is a random number. The increment is the sum of this random number, a constant and the high and low address bytes of the tested byte. The random number is changed before each pass.

4.1.1.2 Test Algorithm

Short test: The byte is simply tested against the expected value. Simple inversion is then carried out.

Long test: The byte is tested against the expected value, and then rotated eight times. It is tested with each rotation. Inversion is carried out bit by bit and checked each time.



Maintenance Facilities

4.1.2 2. FLOPPY DISK TEST

Within the floppy disk test, the following options are available:

FLOPPY DRIVE TEST:
1 - READ MASTER FLOPPY
2 - WRITE-READ TEST FLOPPY
3 - COPY FLOPPY 1 - 2
4 - COMPARE FLOPPIES

4.1.2.1 Read Master Floppy

The aim of this test is check the performance of the drives being tested to ensure that they can read a test pattern from a 'master floppy'. A master floppy will be part of a service engineers 'tool kit' and can only be generated on a well adjusted drive!

To produce your own, the floppy must first be formatted (using the UTIL program) and the test pattern then written using the Write-Read Test Floppy procedure as follows:

Write the complete disk and, when the program starts to read it, enter '0' to abort the procedure. Remove the disk from the drive and attach a write-protect label.

After selecting the 'Read Master Floppy' procedure, insert a master floppy in each of the drives that are to be tested and enter the corresponding drive numbers (1 - 4). Any combination of drive numbers 1 to 4 can be entered.

The following steps are then carried out:

1. Step to track-0 and check the 'track-0' and 'write protect' signals.
2. Step to highest track and check identifier.
3. Step to track-0 and check identifier.
4. Read all tracks from 0 upwards and evaluate the results. In case of error a sector by sector read is started up to two times for each sector. After each step the identifier is also read. The error messages are displayed and printed.
5. After the reading of the last track the next drive is tested. If all drives are ready, the first drive is tested again from point 3. The test pattern and the error messages are described under Write-Read Test Floppy.

Maintenance Facilities

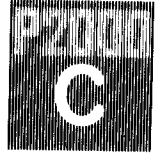

4.1.2.2 Write-Read Test Floppy

Any combination of drive numbers 1 to 4 can be entered.
A formatted disk without 'WRITE PROTECT' label must be inserted in each of the specified drives.

The following steps are then carried out:

1. Step to track-0.
2. Write the test pattern (both sides), step to next track and repeat until the last track has been written.

When all tracks have been written with test pattern:

3. Read each track and check the test pattern from the highest track down to track-0.
4. Test the next drive.
5. When all selected drives have been tested, increment the pass number and test the first drive again.

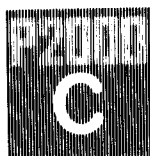

Maintenance Facilities

Testing Pattern:

This is slightly different for each sector of the disk. The disks are written with double density; one sector has 256 bytes, one track has 16 sectors. The 160K disks are written on one side and 40 tracks, the 640K disks are written on both sides and 80 tracks each.

The test pattern for each sector is as follows:

Byte-0 and Byte-1: A random word, different for each writing pass but the same for all sectors.

Byte-2: Number indicating drive and head number.
See Byte-2 in diagram below.

Byte-3: physical track-number

Byte-4: sector-number + 3FH (varies between 40 and 4F).

Byte-5 to
Byte-255: Either:
DB 6D B6 DB 6D B6 DB 6D ...
or B6 DB 6D B6 DB 6D B6 DB ...
or 6D B6 DB 6D B6 DB 6D B6 ...

depending on the remainder of RANDOM/3.

The relationship between the disk drives (1 & 2 internal and 3 & 4 external) and the disk 'sides', the logical drive numbers and the contents of Byte-2 in the test pattern is shown in the following diagram:

...INT...		...EXT...		
1	2	3	4	Physical Drive Number
0 1	0 1	0 1	0 1	Disk 'Side'
1 5	2 6	3 7	4 8	Logical Drive Number (Head)
0 4	1 5	2 6	3 7	Byte-2

Maintenance Facilities

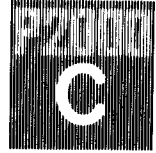

Error Messages:

The message line is built up as follows:

```
##.PASS UNIT (drn) 

|    |
|----|
| ST |
| RD |
| WR |

 TR-(#) n *(error text) (7 HEX bytes) E(n1/n2)
```

where:

[##.] is a count of the passes
 [drn] is the logical drive (head) number
 [ST] means STEP (followed by 'read identifier')
 [RD] means READ
 [WR] means WRITE
 [#] following TR- is the track number; at sector read the track number is extended by 'S' + sector number (1 to 16).
 [n] is the error repetition number (1 or 2)
 [error text] is a short description of the error.
 Note: If a message with '!' appears, it means wrong data without any error message from the disk controller.
 [7 HEX bytes] are the 'result bytes' from the uPD765 disk controller
 [E] means Error Summary where:
 [n1] is the total number of aborted track operations
 [n2] is the total number of detected errors

An expansion of the 'short' error texts is given below:

ABNORM TERM:	Execution of a command was started but not successfully terminated.
BAD TRACK:	The track number stored on the diskette is FF.
CRC ERROR:	FDC detected a checksum error in data field.
DELETED DATA:	A sector with deleted data address mark is found.
END OF TRACK:	FDC tries to access sector beyond the final sector of the cylinder.
FAULT:	The Fault signal is received from the FDC.
IDNT CRC ERROR:	Checksum error is found in the sector identifier.
NO DATA:	FDC cannot find the specified sector.

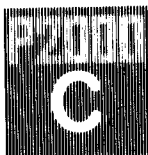

Maintenance Facilities

- NO ADDR MARK: FDC cannot find either Identifier Address Mark or Data Address Mark.
- NO TRACK-0: The Track-0 signal fails to appear after 77 steps during the RECALIBRATE command.
- NO WRITE PROTECTION: The master diskette at 'READ MASTER DISK' has no write protection label.
- DRIVE NOT READY: The FDC is in the 'NOT READY' state and a read or write command is issued.
- UNIT SELECT ERR: Response from a unit that has not been selected.
- WRITE PROTECT: During write, FDC detects a write protect signal.
- WRONG SIDE: The Side Select Signal of the drive is incorrect.
- WRONG TRACK: The track number stored on the diskette differs from the expected number.
- RANDOM DATA ERR!: The Random Data of a sector (byte-0 and byte-1) is incorrect.
- DRIVE DATA ERR!: The Drive data in a sector (byte-2) is incorrect.
- TRACK DATA ERR!: The Track data in a sector (byte-3) is incorrect.
- SECT DATA ERR!: The Sector data in a sector (byte-4) is incorrect.
- WRONG DATA!: The DB, 6D, B6, DB ... pattern (bytes 5 - FF) is incorrect.

If the controller does not finish the read or write track operation within 616 ms the 'DISK NOT READY' message is displayed and the user has to press a key to return to the disk test menu. Such an error can occur if:

- no disk is inserted
- the drive is not connected or is defective
- the READ DATA line on the floppy drive bus is disturbed and the synchronization before some sectors cannot be achieved within the specified time.

Maintenance Facilities

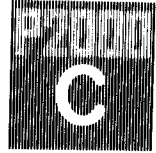

4.1.2.3 Copy Floppy 1 to 2

The disk in drive 1 is copied to drive 2, regardless of data. Data is read track-by-track but in the event of an error each sector of the track is re-read up to two times in an attempt at error recovery. After copying, the copy is verified.

4.1.2.4 Compare Floppies

The disks in drives 1 and 2 are verified on a track-by-track basis. The number of deviations (if any) is displayed and printed.



Maintenance Facilities

4.1.3 3. KEYBOARD TEST

At the keyboard test a figure showing the keyboard is displayed. One key (starting with the top left) is inverted and the user should press the inverted key. If OK, the next one is displayed, otherwise the beeper sounds and the expected and received codes are displayed. If a key input is incorrect 5 times, the corresponding symbol is underlined and the next key is asked for. If no key is pressed within 4 seconds the question 'CONTINUE? (Y/N)' is displayed. After 'Y' the test is continued, after 'N' a printout is made where all faulty keys are marked (keyboard error map).

The P2000C mainboard software has no access to the keyboard position codes, only the converted ASCII codes can be input. For this reason, some special keys (lock, shift, control, supershift) cannot be checked individually. These special keys are checked together with an auxiliary key. Both keys are inverted on the display. The special key must be pressed and held and the auxiliary key then pressed.

If all keys are ready, an OK message or the keyboard error map is printed (if an error has been found).

4.1.4 4. SCREEN TEST

Within the screen test, the following options are available:

- 1 - ALPHANUMERIC
- 2 - GRAPHICS
- 3 - HIGH RESOLUTION GRAPHICS
- 4 - SCREEN ADJUSTMENT
- 5 - SPECIAL FEATURES

4.1.4.1 Alphanumeric Test

A test figure containing 23 lines with 23 different alphanumeric characters (each line has the same character 80 times) is displayed and an instruction to type any key. It is repeated until all alphanumeric characters are displayed. At the end the user must qualify the result (OK or not).

Maintenance Facilities

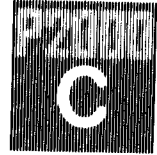

4.1.4.2 Graphics (Mosaic Graphics) Test

Two pictures are generated, each containing all graphics characters. Both pictures are symmetric and the second one is the inverse of the first. The user must qualify the figures.

4.1.4.3 High Resolution Graphics Test

Two pictures are shown, the first with 256 x 252 dots and, after pressing any key, the second with 512 x 252 dots. Both display an 'X' shape with a (logical) circle in the middle. The user must qualify the result.

4.1.4.4 Screen Adjustment Test

A figure is displayed where lines and columns of letter 'O' divide the picture into 4 x 4 equal parts to check the linearity. All other character positions are filled with '.'. In addition, the edges are inverted to show the screen adjustment clearly.

WARNING: The last position in the last line is not displayed to avoid scrolling up.

The user must qualify the result.

4.1.4.5 Special Features

The screen is inverted and six lines with the letter 'A' are displayed. Alternate letters have the 'special' feature:

1st line: Underline
2nd line: Quarter bright
3rd line: Half bright
4th line: Bold
5th line: Inverted
6th line: Flashing

The user must qualify the picture.

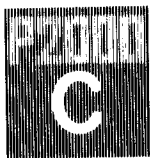

Maintenance Facilities

4.1.5 5. PRINTER CHARACTER TEST

If the printer is not ready, the beeper sounds. If any key other than '0' (zero) is pressed the ready bit is checked again. If the printer is found to be ready the test is started. Pressing the key '0' aborts the test.

The print character test is a simple test for all printable characters. Six lines are displayed with the following characters:

20-3F, 40-5F, 70-7E, A0-BF, C0-DF, E0-FE

The program fully considers the printer translation table of the booting system disk.

Afterwards a 'print screen test' is made with 8 shifted lines. If the terminalboard sends all the expected characters, the 'PRINT SCREEN TEST OK' message is sent.

If too many characters have been sent, the message 'TERMINAL BOARD ITEM 7406 USART-8251 IS DEFECTIVE!' is displayed. The indicated circuit must be replaced by any of the following types:

Type	Manufacturer
INS 8251N	National Semiconductor
COM 8251	SMC
D8251A	Intel
NEC D8251AFC	NEC

4.1.6 6. BEEPER TEST

The beeper sounds periodically until the user presses a key and qualifies the beeper.

4.1.7 7. SUMMARY

The summary has the following format:

SERIAL NUMBER:	(user entry)	
NATIONAL VERS:	NL/UK (or other)	according to users' answers in
FLOPPY DRIVES:	640K (or 160K)	the configuration menu
DATE:	(user entry)	
INSPECTED BY:	(user entry)	

If a printer is connected, the summary is printed.

Maintenance Facilities

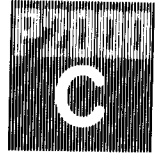

4.1.8 8. DEBUGGER

The debugger in the IPL ROM is called (see section 2.2) and the user can observe the memory or disk contents. On entry a line is displayed:

RETURN TO MAINTENANCE with: G xxxx

where xxxx is a 4 character hexadecimal address.

The user MUST NOT CHANGE any memory contents except 4000 to 7FFF, otherwise the maintenance program is corrupted and CANNOT BE REUSED after return.

4.2 Terminal Board Memory Test

The actual tests are in the MTS.HEX and MTL.HEX files, which must be present on the loading disk.

The following menu will be displayed:

TERMINAL BOARD MEMORY TEST

1 - ONE PASS

2 - ENDLESS

The file MTS.HEX or MTL.HEX is loaded into memory and then into the terminal board with the 'LOAD INTEL HEX FILE' feature.

The RAM in the terminalboard is checked in two parts:

Range 1: C000H - FFFFH

Range 2: 8000H - BFFFH

Each range is written with the test pattern and checked 256 times. In case of error the address is displayed and the beeper activated.

In the short test the procedure is carried out 3 times, after which the terminal board is reset. In the long test, the test runs continuously until the RESET button is pressed.

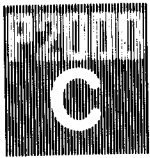

Maintenance Facilities

4.3 Hard Disk Test

4.3.1 GENERAL TEST PHILOSOPHY

Make sure that the jumper on the controller card is set to 256 bytes/sector.

The hard disk should be formatted (using UTIL) before testing.

The individual testing routines send different commands to the XEBEC controller and in case of error the reason is asked (if possible). A single command has the following structure:

1. Define timeout for the operation.
2. If 'BUSY' bit active:
'XEBEC CONTROLLER NOT READY'.
3. Make 'select' for the controller. If BUSY is still inactive:
'BUSY INACTIVE AFTER SELECT'.
4. Send command. Repeat the following procedure 6 times:
If REQUEST bit inactive within specified time:
'COMMAND NOT FETCHED BY XEBEC', else send command byte.
5. Command is executed. Get status byte. If MESSAGE and REQUEST bits are not active within timeout:
'FIRST STATUS BYTE NOT RECEIVED'.
This is the case when the sector size jumper is incorrect.
6. Get 'null byte'. If REQUEST bit inactive within timeout:
'SECOND STATUS BYTE NOT RECEIVED'.
7. Check DMA address register. If data transfer incomplete (due to hardware error on handshake lines):
'DATA TRANSFER ON DMA TOO SHORT'.
8. If bit-1 of the status byte (see 5) is 1, make a 'Request sense status' command to check the reason for the error and the accurate disk address of it.

Maintenance Facilities

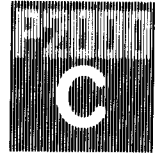

The following messages are possible:

NO INDEX DETECTED FROM DRIVE
 NO SEEK COMPLETE FROM DRIVE
 WRITE FAULT FROM DRIVE
 DRIVE NOT READY (after selection)
 NO TRACK-0 (found after recalibrate)
 IDNT CRC ERROR (read error in identifier field)
 UNCORRECTABLE DATA ERROR
 NO ADDRESS MARK (address mark not found)
 Note: This message appears when two drives with the same
 jumpering are connected to the XEBEC controller.
 TARGET SECTOR NOT FOUND
 SEEK ERROR
 CORRECTABLE DATA ERROR
 ILLEGAL DISK ADDRESS
 BAD TRACK FLAG DETECTED
 FORMAT ERROR
 RAM BUFFER FAILURE
 PROGRAM MEMORY CHECKSUM ERROR
 ECC DIAGNOSTIC FAILURE

9. If a test pattern is read, the following structure is expected on each sector:

Byte-0 and Byte-1: A random word, different for each pass.
 Byte-2: FF for drive-0 or FE for drive-1
 Byte-3: Logical address HIGH on the disk
 Byte-4: Logical address MIDDLE on the disk
 Byte-5: (Logical address LOW on the disk) AND 0C0
 Byte-6: Buffer address HIGH (40 to 9F)
 Byte-7 to
 Byte-255: Either:
 DB 6D B6 DB 6D B6 DB 6D ...
 or B6 DB 6D B6 DB 6D B6 DB ...
 or 6D B6 DB 6D B6 DB 6D B6 ...
 depending on random data in byte-0.

Errors in the test pattern will result in the following messages:

RANDOM DATA ERROR!: error in bytes 0 or 1
 DRIVE DATA ERROR!: error in byte 2
 TRACK DATA ERROR!: error in bytes 3, 4 or 5
 SECT DATA ERROR!: error in byte 6
 WRONG DATA!: error in bytes 7 to FF

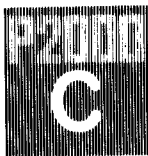

Maintenance Facilities

4.3.2 SELECTABLE TESTS

The following tests are available:

XEBEC CONTROLLER INTERNAL DIAGNOSTICS
SELECT DRIVE AND SHORT TEST
DRIVE READ ONLY TEST
DRIVE WRITE-READ TEST

4.3.2.1 XEBEC Controller Internal Diagnostics

The controller checks its internal processor, data buffers, ECC (error detection and correction) circuits, the checksum of the program memory and a diagnostics on the RAM buffer. No drive is accessed. The test is repeated until the '0' key is pressed.

4.3.2.2 Select Drive and Short Test

At first the user is warned that the system tracks on his hard disk will be lost but no files will be damaged. Then he has to select the drive (1 or 2). It is assumed that the drive is correctly formatted. The selected drive and drive-to-controller interface is tested. The controller sends recalibrate and seek commands to the selected drive and verifies sector 0 of all the tracks on the disk. Afterwards a write-read test is performed on the first 8K of the disk. Finally the alternative drive is read and if the same contents is found a warning is displayed saying that the same disk hangs on drive 1 and 2. It is not a serious error if only one disk is attached to the controller (the drive select jumper on the drive is not set properly).

If no error has been found the following message is displayed (for 10MB hard disk):

```
DIAGNOSTICS OF DRIVE 1 DISK ADDRESS 009900 OK  
SHORT WRITE-READ TEST OK
```

The displayed hexadecimal disk address gives the disk capacity in sectors (256 bytes). In the case of a 5MB hard disk its value is 004C80.

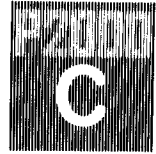

4.3.2.3 Drive Read Only Test

The data is read continuously from the hard disk drive selected using the 'SELECT DRIVE AND SHORT TEST' procedure (or from drive 1 if nothing has been selected). If the last track is reached, the procedure starts again until the '0' key is pressed. In case of error, the address of the faulty sector is displayed together with an error text.

4.3.2.4 Drive Write-Read Test

The user is warned that this procedure destroys ALL data on his hard disk and he can continue only after typing 'YES'. Each sector of the disk is written with a unique test pattern. When the disk is full its contents is checked and the procedure is repeated until the '0' key is pressed. Afterwards 'E5H' is written to each byte of the first 16K of the hard disk. In the case of the 10 MB hard disk it is recommended to format the disk again because the directory in the higher part of the hard disk will not be cleared by E5.

4.4 Memory Extension Board Test

The program first checks that a memory Extension Board is fitted. If not, the message 'WRONG BOARD' is displayed. The program checks the memory quality as well as the bank and cache switching properties of the P 2092 memory extension board.

Two tests are available: SHORT and LONG.

Memory Write-Read Test

According to the user selection either the short or the long test is carried out. In the short test a simple rotating pattern is used and the testing is a simple byte check. The long test uses a quasi-random pattern and during testing the byte is rotated 8 times and checked each time. Both of them execute a memory write-read test and a bank switching test.



Maintenance Facilities

Before the actual test the checksum of the 0 - 7FFF range of the system RAM is recorded and checked after each testing stage. In the event of an error in this check a message is displayed:

CHECKSUM ERROR IN SYSTEM RANGE, PROGRAM DAMAGED!!!

and the program halts. It means that during a memory write to the extension RAM the system RAM has been also been written.

The test is carried out in the cache mode. During testing a letter is shown indicating the procedure in progress:

F : Fill extension memory with the testing pattern
 T : Test a cache (16 times)
 I : Invert a cache (16 times)
 T : Test the inverted pattern (16 times)

FTTTTTTTTTTTTTTTTTIIIIIIIIIIIIIIIIIIITTTTTTTTTTTTTTTTT

The error message format (printed and displayed) is as follows:

22.PASS BANK-1 (IC:7014-7021) ADDRESS: 10XXXXXX XXXXXXXX BITS: 011GGXXG

where: the number preceding PASS is the pass number
 BANK = 1..4 and indicates the faulty page number. It is followed by the IC position range of the corresponding bank.

The symbols in the BITS fields represent the condition of the bits within the range indicated by the two address bytes:

0: if this bit is wrong, it is always set at 0
 1: if this bit is wrong, it is always set at 1
 X: if this bit is wrong, it was set at 0 or 1
 G: no errors found on this bit (always Good)

The example shows that when testing BANK-1, errors were found in the range 8000H to BFFFH. These errors were:

all errors in bit 7 - bit set to 0
 all errors in bits 6 & 5 - bit set to 1
 errors in bits 1 & 2 - sometimes 0, sometimes 1
 No errors were found in bits 0, 3 or 4

Maintenance Facilities

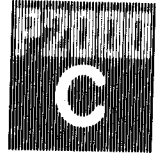

Bank Switching Test

If no error is found in the memory write-read test, a bank switching test is carried out.

The system memory bytes at the addresses of 0002, 4002, 8002 and C002 are saved and the program is multiplied to all banks in the WRITE-ALL mode. (If this mode does not work, the program hangs without any message because there is no other way to test the switching mechanism).

Then each cache (16K byte unit) is marked on byte-2 with a specific number (08, 18, ... F8). The possible switching modes (CROMIX, MP/M and OASIS) are activated and each cache is checked against the specifications.

The recorded addresses in the normal system RAM are then checked. Afterwards the marked byte of each cache is checked in CACHE-MODE as well as the 0 cache that is always active in the 0-3FFF range.

If any of these tests fail, the whole switching map is displayed showing the expected and received values. The bytes with error are inverted. As the whole map is longer than one page the second part is displayed after typing any key. The next keyboard entry returns to the main menu, and no further testing takes place.

After a successful test the program stops and waits about 5 seconds. If the user types '0' during this time (or has done so during the test), the program returns to the selection menu. Otherwise the test is repeated.

4.5

Parallel (IEC) Board Test

The program first checks that a memory extension board is NOT fitted. If it is the 'WRONG BOARD' message is printed and the test is not executed.

The reserve CTC channel (CTC2+2) is enabled for interrupts.

The selection menu is then displayed:

```
SELECT PARALLEL (IEC) BOARD TEST
1 - STANDARD TEST
2 - CONTINUOUS TEST WITHOUT PLUG
3 - CONTINUOUS TEST WITH PLUG
```

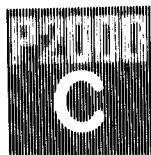

Maintenance Facilities

4.5.1 STANDARD PARALLEL (IEC) BOARD TEST

A test is first carried out with an empty socket. All 65536 combinations are written to the output ports and read. In case of error, an error message is displayed with the following format:

```
DATA 7 6 5 4 3 2 1 0   CONTROL 7 6 5 4 3 2 1 0   GOOD:0,1   BAD:L,H
FO   0 0 0 0 1 1 1 1   67           1 H H L L 0 0 0
```

This should be interpreted as follows:

It says that the byte FO has been applied to the data port and there is no error (the displayed bit values can be measured on the connector). The byte 67H has been applied to the control port where bits 6 & 5 are HIGH (instead of LOW) and bits 4 & 3 are LOW (instead of HIGH). Consider that the output bits are inverted!

The test continues with a user selected input:

0-QUIT 1-REPEAT 2-CONTINUE 3-SCOPE

Selections 0, 1 & 2 are self explanatory; 3 leads to the choice:

0-QUIT 1-READ 2-WRITE

If 1 or 2 are entered a further selection is required:

PORT: 0-QUIT 1-CONTROL 2-DATA

The user can thus select a continuous READ or WRITE test on the CONTROL or DATA port.

Maintenance Facilities

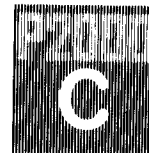

If WRITE has been selected, up to 10 hexadecimal bytes can be entered. After 'CR', the user can check the board with an oscilloscope.

Pressing any key will stop the procedure and return to the:

QUIT-READ-WRITE menu.

After the test with an empty socket, the user has to connect a simple IEC socket with the following interconnections:

[1-5], [2-6], [3-7], [4-8], [13-10], [14-9], [15-11], [16-17]

This connector makes a logical AND between the corresponding bits of the two output ports. (From the processor side it is a logical OR because of the inversions). When the connector is fitted and any key is pressed, the test is repeated.

During the test the number of CTC interrupts is counted and at the end a message indicates if the count was too high or too low.

4.5.2 CONTINUOUS TEST WITHOUT PLUG

All the 65536 combinations are written to the two output ports and the input ports are checked. The error procedure is the same as with the Standard Parallel (IEC) Board test. If ready a '.' is displayed and a new run is started until any key is pressed.

4.5.3 CONTINUOUS TEST WITH PLUG

The same procedure is carried out in this test, the difference being in the expected results due to the interconnections.

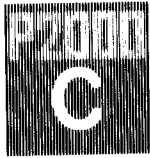

Maintenance Facilities

4.6 Reconfigure Maintenance Program

A menu is displayed with the supported national versions:

```
SELECT NATIONAL VERSION:
CH-D      =  Switzerland German
CH-F      =  Switzerland French
D/A       =  Germany and Austria
E         =  Spain
F/B       =  France and Belgium
I         =  Italy
NL/UK     =  Netherlands and United Kingdom
S/SF      =  Sweden and Finland
```

After national version selection, the following message is displayed:

```
Define disk configuration (1=160K, 2=640K, 3=not existing)
INTERN:
EXTERN:
```

For example:

```
Define disk configuration (1=160K, 2=640K, 3=not existing)
INTERN: 1  (defines drives 1 & 2 as 160K)
EXTERN: 2  (defines drives 3 & 4 as 640K)
```

Finally, the printer speed has to be selected from the following:

```
1 - 1200
2 - 2400
3 - 4800
4 - 9600
5 - 19200
```

This printer speed overwrites that set by the CP/M system.

The information entered during this program is written back to the disk. Therefore the disk must not be removed until the selection menu is displayed again.

Information supplied by the user is considered in the keyboard, screen, disk and printer tests.

Maintenance Facilities

4.7 Burn-in Test

This test procedure is designed for factory testing and will not be described in this document.

4.8 Short Burn-in Test

This test procedure is designed for factory testing and will not be described in this document.